

THE LIFTING MEANS SYSTEM.

Main catalogue version 1 | English

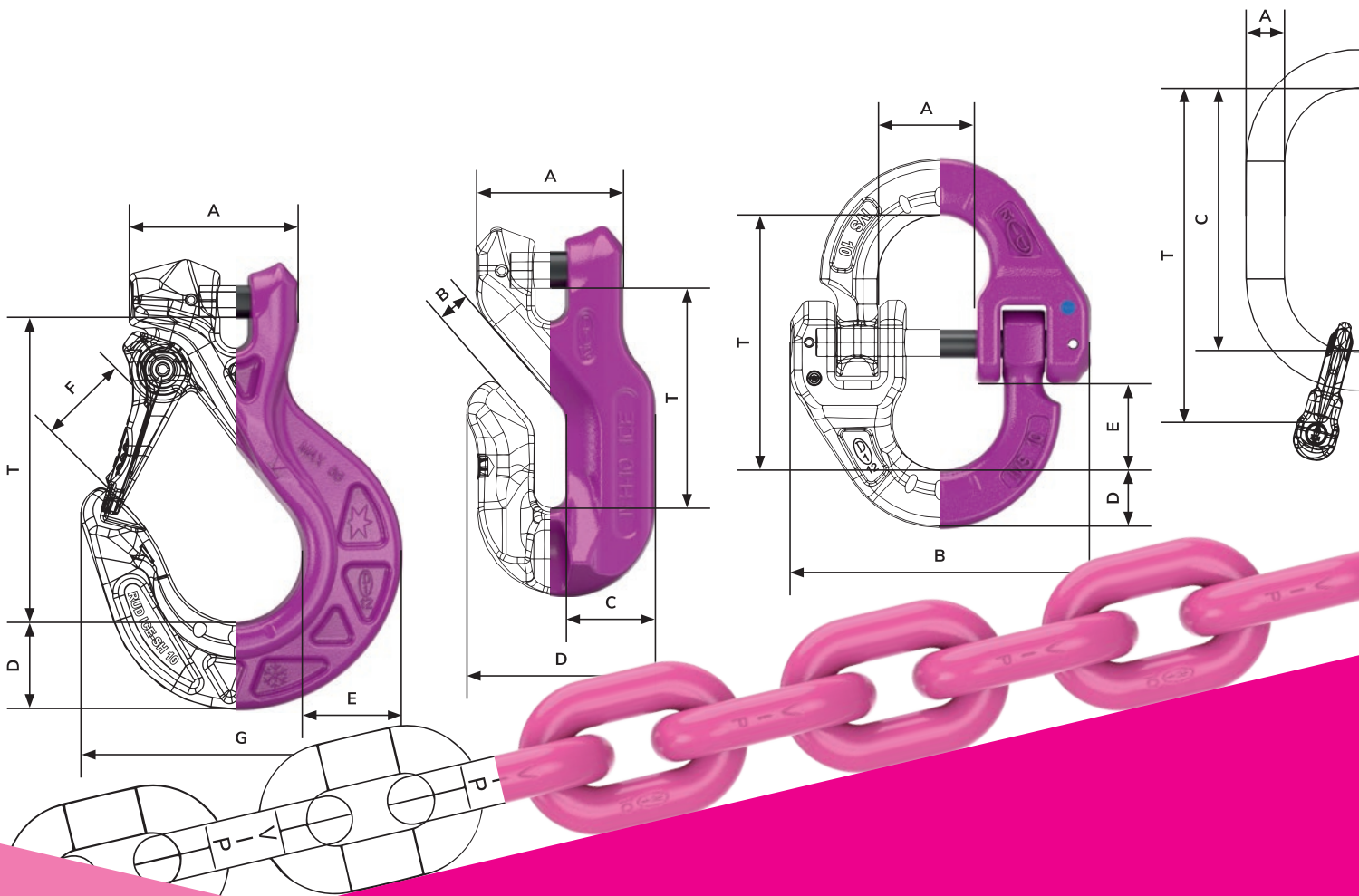

PRODUCT FEATURES: EXPLANATION OF SYMBOLS.

This overview is for the sole purpose of explaining the symbols used in the catalogue. The actual values or features (here replaced by "X") can be found on the respective product pages.

X:1

Safety factor (e.g. 4:1) for lifting means (safety against breakage).



All load-bearing elements are 100% electromagnetically crack-tested.

**-XX°
XXX°C**

Operating temperature range of the lifting means without permanent reduction of load capacity.

**XXX°C
max.**

Maximum operating temperature of the lifting means with percentage, product-dependent load capacity reduction.



Easy testing and documentation. With the RUD BLUE-ID system (equipped with an RFID chip).

**DGUV
TEST**

Component has been approved by the DGUV (German Social Accident Insurance) and has the corresponding certificate.

**DNVGL
TEST**

With DNVGL approval. The product is suitable for marine and offshore applications.

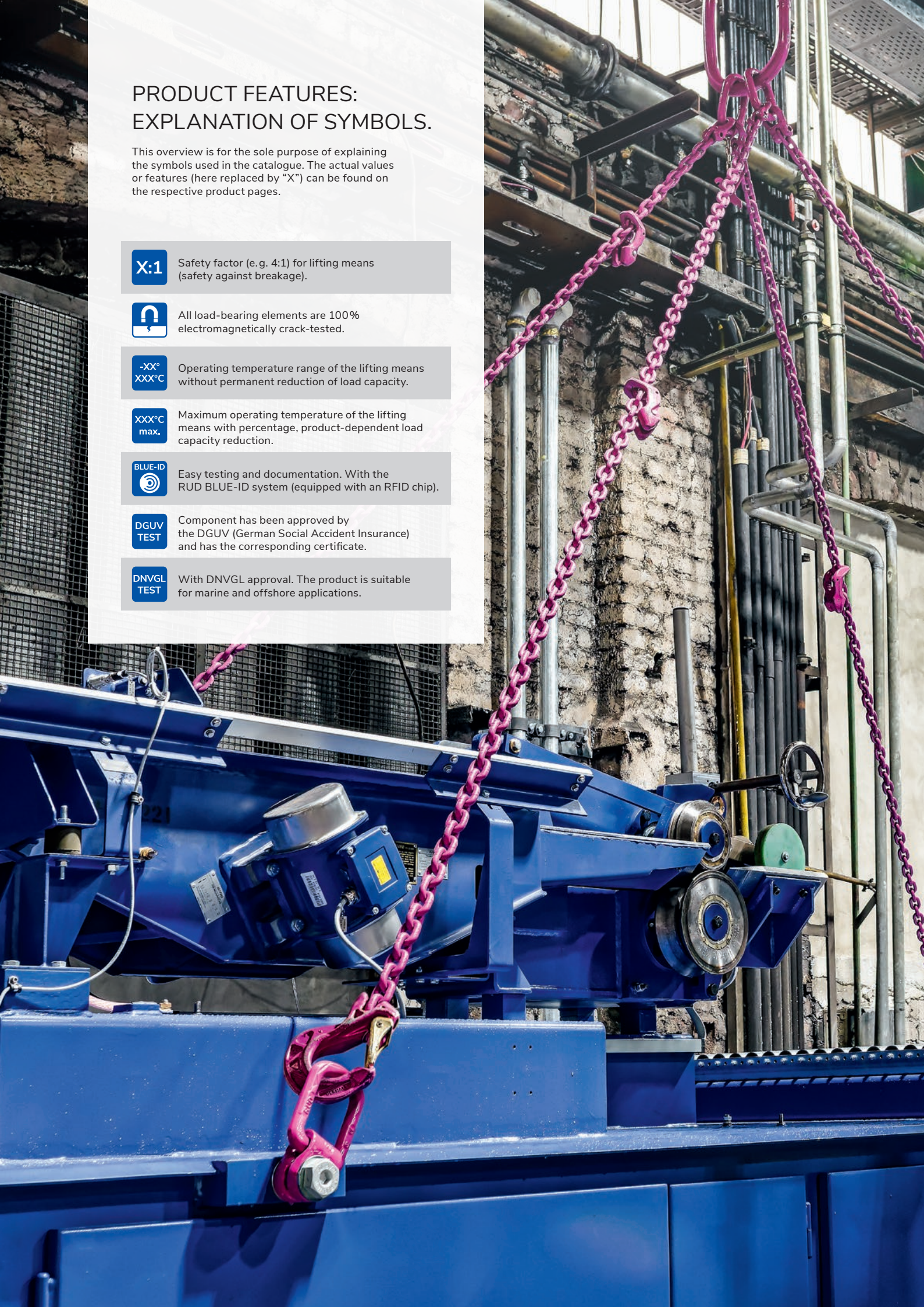

The background of the advertisement is a composite image. On the left, there is a view of an industrial facility with a concrete wall, a blue metal structure, and a purple chain hanging down. On the right, there is a close-up of a blue forklift with a large white container being lifted. The forklift has a red number '3' on its mast. The overall scene is industrial and brightly lit.

WELCOME TO THE WORLD OF RUD.

MORE THAN PRODUCTS: YOUR PARTNER FOR SOLUTIONS.

From mould making and automotive industry to the offshore sector: RUD products stand for innovation, quality, ergonomics and safety. As a dynamic, globally active company, we develop chain systems and components for a variety of applications. And all this for 145 years. Furthermore, we have 40 years of experience in lifting technology and load securing – with 700 different attachment point variants meeting the highest requirements.

At RUD, however, you get much more than just products. Our aim is to always offer you the perfect solution to meet your specific requirements. We also support you with well-planned consultancy and services to make your projects a success.

Welcome to RUD.

CONTENT.



OUR CLAIM	6-7
EFFICIENCY AND SAFETY	8-9
RUD MILESTONES	10-11
OPTIMAL CONFIGURATION OF CHAIN SUSPENSIONS	12-17
GRADES	18-19
ADVANTAGES OF ICE- AND VIP-CHAINS	20-23
LIGHT AND HIGH-PERFORMANCE – RUD ICE	24-25
RUD LIFTING MEANS IN VIP-QUALITY	26-27
RFID: RUD BLUE-ID SYSTEM	28-29
WLL AT A GLANCE	32-33

THE RUD ICE-CONSTRUCTION KIT	34-63
ICE-COMBINATION OPTIONS	38-39
ICE-LIFTING MEANS	40
ICE-KZA ICE-IDENTIFICATION TAG	41
IAK-RG-1 / -RG-2 / -RG-4 ICE-STANDARD MASTER LINKS	42-43
ISAK-RG-1 / -RG-2 / -RG-4 ICE-SPECIAL MASTER LINKS	44-45
IVS ICE-CONNECTING LINK	46
IVH ICE-SHORTENING HOOK	47
IH ICE-H-CONNECTOR	48
IMVK ICE-MULTI-SHORTENING CLAW	49
IW ICE-BALANCER	50-51
ICE-CURT-K ICE-BAR SPINDLE TENSIONER WITH LOCKING HANDLE FOR LIFTING	52
ISH ICE-STAR HOOK	53
IWH ICE-FOUNDRY HOOK	54
IMEG ICE-DUMPER TRUCK SUSPENSION-RING	55
IAGH ICE-CLEVIS SELF LOCKING HOOK	56
IMAGH ICE-CLEVIS SELF LOCKING HOOK FOR DUMPER TRUCKS	57
IRG ICE-CLEVIS CONNECTOR	58
ICE-MINI CONSTRUCTION KIT	60-61
ICE-SPARE PARTS	62-63

THE RUD VIP-CONSTRUCTION KIT	64–117
VIP-COMBINATION OPTIONS	72–73
VIP-LIFTING MEANS	74
VKZA VIP-IDENTIFICATION TAG	75
VBK-1 / -2 VIP-MASTER LINK FOR SMALLER LOAD HOOK	76–77
VAK-1 / -2 / -4 VIP-STANDARD MASTER LINK	78–79
VSAK-1 / -2 / -4 VIP-SPECIAL MASTER LINK	80–81
UW-PP + VWA UNIVERSAL SWIVEL POWERPOINT + VIP-SWIVEL CONNECTOR	82
PP-X-B VIP-SPECIAL MASTER LINK – LIGHTWEIGHT CONSTRUCTION	83
VVH VIP-SHORTENING HOOK	84
VMVK VIP-MULTI-SHORTENING CLAW	85
VV VIP-SHORTENING CLAW	86
VGIL VIP-ISOLATING LATCH	87
VV-SCH / VC-SCH VIP-FOOL-PROOF SHACKLE / VIP-SHACKLE HIGH-TENSILE	88
VV-GSCH / OCTOPUS VIP-FOOL-PROOF SHACKLE / VIP-BALANCING ASSEMBLY	89
VVS VIP-CONNECTING LINK	90
VIP-DOMINATOR CONNECTION LINK FOR ENDLESS CHAINS	91
VW VIP-BALANCER	92–93
VCB VIP-CHAIN BLOCK	94
VCG VIP-CONTROL LINK	95
VSRS VIP-SPREADER BAR FIXED	96
VS RV VIP-SPREADER BAR ADJUSTABLE	97
VCGH VIP-COBRA HOOK WITH SAFETY LATCH	98
VCÖH VIP-COBRA EYE HOOK WITH SAFETY LATCH	99
VWH VIP-FOUNDRY HOOK	100
VAGH-S VIP-SELF-LOCKING HOOK	101

VBMHWA VIP-BALE HOOK	102
HWA VIP-HOIST SWIVEL ADAPTER	103
VCH VIP-CONTAINER HOOK – 12.5 t	104
VCH-K 16 VIP-CONTAINER HOOK – 10.0 t	105
VCH-SL 22 VIP-CONTAINER HOOK – 20.0 t	106
VERG VIP-PLUG-IN CONNECTOR	107
VIP-MAXI CONSTRUCTION KIT	108–113
VIP-MINI CONSTRUCTION KIT	114–115
VIP-SPARE PARTS	116–117

RUD IDENTIFICATION TAGS	120–121
RUD CONFIGURATION TOOLS	122–123
INSPECTING LIFTING MEANS	124–127
CROSS-SELLING: OFFER WITH A SYSTEM	128–129
GLOSSARY	130–131



Always a nominal thickness lower than grade 8.
RUD chains made from patented ICE-Material can substitute grade 8 chains of the next highest nominal thickness thanks to their extremely high strength. The decisive advantage: An ICE-Lifting mean or lashing chain is more than 30 percent lighter and the working ergonomics are noticeably improved



Higher WLL with the same diameter.
RUD chains and components of grade 10 (VIP) offer up to 30 percent higher WLL than grade 8 with the same chain diameter. This means that VIP-Chains from 20 mm upwards are always one nominal thickness thinner, while their weight is reduced by up to 50 percent.

OUR CLAIM: MAXIMUM QUALITY, BEST CUSTOMER ORIENTATION.

Innovation, perfection and the motivation to achieve added value for our customers: That is RUD's passion. Being a technological think tank, we repeatedly set standards for load securing and lifting technologies with our lifting and lashing equipment.

Our chain production facilities are among the most modern of their kind. Highly qualified specialists work here, who are never satisfied with the status quo. Because our thinking is focused on meeting customer needs and maximum benefit for the user. The long-term partnership with our customers, their satisfaction and their trust are our focus.

RUD. MADE IN GERMANY.

All RUD products around lifting and moving of loads have something important in common: They are developed and manufactured by us in Germany. In R&D alliances with research institutes, universities, suppliers and customers. With plenty of know-how, high creativity and state-of-the-art technology. This results in products and solutions of outstanding material quality, high robustness and exemplary ergonomics. In a nutshell: Quality made in Germany – made by RUD.

■ **MADE**
■ **IN**
■ **GERMANY**



AT HOME INTERNATIONALLY.

Not only our products, but also RUD's solution and consulting expertise are available to you all over the world. This is ensured by a large number of subsidiaries, associated companies and specialised RUD trade partners. Satisfied users of RUD lifting and lashing solutions can also be found in almost all industrial sectors.

TRADITION MEETS FUTURE.

Time and again, RUD is at the forefront of important developments. Many things considered standard today for lifting and lashing originated from RUD's think tank. In 1953, RUD was the first chain manufacturer to receive the inspection stamp H1 for high-strength chains, in 1972 it was the first to receive approval for grade 8 (H1-8) and in 2007 for round steel chains of the highest grade 12 (D1-12) (ICE). To simplify test processes, we have long equipped many products with RFID transponders as standard and offer a complete hardware and software system for efficient test management. The latest milestone: In 2019, RUD presented the first lifting point that "thinks" and can thus avoid dangerous transverse loads. There is still a lot for us to do, join us into the future.

AWARD-WINNING SERVICE.

Numerous awards prove it: RUD's innovative strength and performance are outstanding – in the industry and beyond.



EFFICIENCY IN LIFTING AND MOVING? LET'S TALK ABOUT IT.

Production management, mechanical engineering:

**“MOVING LOADS MUST NOT ONLY BE SAFE,
BUT COST-EFFICIENT TOO.”**

“When you move heavy and valuable loads every day, cost efficiency is just as important as safety. That's why we need products that are beyond all doubt in terms of quality and that perfectly meet our high requirements. A long service life through the use of modern materials and high-quality workmanship is a very important efficiency criterion, but user friendliness is also very important to us. At the same time, we need a partner who can advise us on very specific projects and offer a tailor-made lifting solution. Because sometimes only an individual solution is ultimately safe and cost-effective.”

Technical consultancy, RUD Group:

**“THE CUSTOMER BENEFIT IS ALWAYS AT THE FOREFRONT
FOR US. AND IT IS NEVER ONE-DIMENSIONAL.”**

“At RUD we have a clear focus: We want to meet the needs of our customers in the best possible way. Both with 'standard products' and special solutions. Our modern material technologies such as ICE 120 and VIP 100 have set standards in many branches. This not only makes our products extremely reliable and low-wear, they are also exemplary in terms of ergonomics thanks to good ideas and clear weight advantages. The special feature: In the case of highly specialised lifting or transport challenges, we literally stand by our customers and advise them. Our experts listen carefully to you, offer detailed advice and then develop a very specific solution that perfectly suits the respective task. Whether it's about a new lifting application or the transport of very special loads.”



FIND OUT MORE ABOUT
THE PRODUCT SOLUTIONS
AT RUD.



RUD MILESTONES.

1875

Establishment of the "Rieger & Dietz Kettenfabrik" by Carl Rieger and Friedrich Dietz in Aalen-Unterkochen.

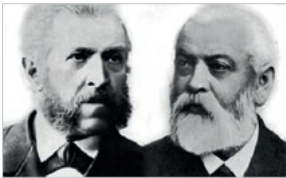

1953

RUD is the first chain manufacturer with test stamp H1 for high-strength quality chains.



1967

First chain manufacturer with approval for grade 5 (H1-5).

1981

Development of the first lifting points RBG (load ring for bolting) and RBS (load ring for welding).



1985

Expansion of the lifting point program to include the LBS (load ring for welding) and LBG (load ring for bolting).



1994

First chain manufacturer with approval for the VIP-Special grade 8S (H1-8S) with up to 30 % higher WLL than grade 8.



VRS as the first eyebolt with adjustable direction.



1945

Beginning of industrial quality chains manufacturing.



1972

First chain manufacturer with approval for grade 8 (H1-8).



1990

WBG (load ring thread).



1992

Certification of the quality management system according to DIN/ISO 9001.



Certified as the first chains manufacturer with integrated quality and environmental management system according to ISO 9001/14001.

2002

First universal lifting point type PP-S.



2006

Approval for grade 10 (VIP) (H1-10).



2010

ABA – first rigid lifting point that can be loaded on all sides.



2016

VLBG-PLUS – with Ø 45 % higher WLL.



2019

RUD BLUE-ID SYSTEM



OPTILASH-CLICK – the click-in lashing point by RUD. Fixed variant: OPTILASH-FIX.



2007

DNVGL approval as manufacturer of seamless chain and chain accessories for lifting, lashing and towing according to GL regulations for metallic materials (Certificate WZ 1218 HH 3).

First chain manufacturer with approval for grade 12 (ICE) (D1-12).



2014

RUD is the first lashing and lifting means manufacturer to equip many products with RFID transponders.

Presentation of the ICE-BOLT® – A revolution in bolting technology.



2019

RUD ACP-TURNADO – The first lifting point, whose body rotates automatically in the direction of force.



OPTIMAL CONFIGURATION OF CHAIN SUSPENSIONS.



FROM THE MASTER LINK TO THE FINAL COMPONENT: WHAT YOU SHOULD CONSIDER.

From the master link to the final component: Configuring chain suspensions is full of challenges. Safety and efficiency are the top priorities for us. As a globally recognised specialist in the field of lifting and moving loads, we support you in your daily lifting tasks. With our ICE- and VIP-Construction kits, for example, we have created the basis for ensuring that RUD components with different WLL cannot be accidentally combined. On these pages, you will learn how to configure your individual suspension optimally for your respective applications.

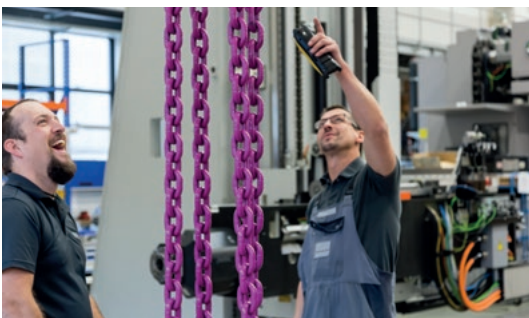

WHAT IS A CHAIN SUSPENSION IN ACTUAL FACT?

In the world of lifting means, chain suspensions form the connection between the sling and the load. It consists of several components. Suspensions can be purchased fully configured – depending on the weight, size and shape of the load.

Components of a suspension are:

- Master link
- Chains (in one or several strands)
- End component (e.g. hooks)
- Any connecting elements (to connect two chains)
- Any shortening elements (to shorten chains)
- Any further elements (e.g. balancer)

WHAT IS THE ADVANTAGE OF A CHAIN SUSPENSION WHEN LIFTING?

Chain suspensions can be configured very flexibly according to the load to be lifted. The variety of available components and WLL is high, so that a large number of lifting tasks can be solved with one suspension. For example, the chain of a suspension can be easily and safely extended or shortened with special components. This allows the length of the chain strands to be adapted to the shape or weight distribution or centre of gravity of the load.

WHICH REQUIREMENTS DOES A CHAIN SUSPENSION HAVE TO FULFIL?

Approval.

The standards DIN EN 818, DIN EN 1677 and E DIN 21061 guarantee a maximum of safety in the manufacture of chains. Lifting means that are approved and tested in accordance with these international standards are authorised by the German Social Accident Insurance (DGUV) to bear the so-called H-stamp. Do you value quality and safety? Then check whether your lifting means has an H-stamp.



Identification.

Furthermore, every lifting chain has an identification tag from the manufacturer, which must be permanently fixed to the chain. Among other things, it provides information on the WLL, the nominal diameter and the grade. If this tag is missing, you must not use the chain, since important characteristic values of the chain and thus of the suspension cannot be determined. VIP- and ICE-Identification tags from RUD also serve as chain gauges.



Safety factor.

For lifting chains, the safety factor 4 is required by law. This means that the manufacturer must prove that the breaking load of the lifting chains is at least four times its working load limit (WLL).

Incidentally, since wire ropes and textile lifting means have a lower elongation under load and thus a lower energy absorption capacity than lifting chains, higher safety factors (5 or 7) apply to them.



Attention: If you assemble suspensions yourself, you may only use lifting chains! Lashing chains are not permitted for lifting applications, as they have a different safety factor than lifting chains.

CONFIGURATION OF A CHAIN SUSPENSION: WHAT QUESTIONS DO YOU NEED TO ANSWER FOR YOURSELF?

To select the individually suitable components for a chain suspension, you need answers to some important questions in advance. As soon as you know the answers, we recommend our **digital suspension configurator** at www.rud.com. Enter all required values here – and then you will receive a precise suspension recommendation.

1. What load (weight) should be transported or lifted with the chain suspension?

In order to select lifting chains and other suspension components with the correct WLL, you must know the weight of the load to be lifted. It is the first and most important value which you need for your suspension calculation.

2. How many strands should the suspension have?

Loads that are to be lifted using a chain suspension have already mounted lifting points or other attachment options sometimes. Their number depends on factors such as symmetry or asymmetry, centre of gravity and the shape of the load. As far as possible, all attachment options must be used for the lifting operation. Therefore, the number of strands of the used suspension results from their quantity. A suspension can have up to four strands. Attention: According to DGUV rule 100-500, the single strand WLL applies in the event of asymmetrical loading of a multiple strand suspension.

3. What usable length should the suspension have?

Depending on the height of the hall, the height of use and the size of the load, you need a certain usable length for your suspension. The permissible angle of inclination β of the suspension, which is indicated in this catalogue for each suspension, is also important. It must lie between 0° and 60° (calculated from the vertical). If the angle of inclination β is more than 60° , you must increase the usable length of the suspension so that the angle is less than 60° .

4. What is the distance to the existing lifting points?

The distance between the lifting options used has an effect on the angle of inclination β of the suspension. This distance is therefore taken into account in the formula for calculating the optimum suspension.

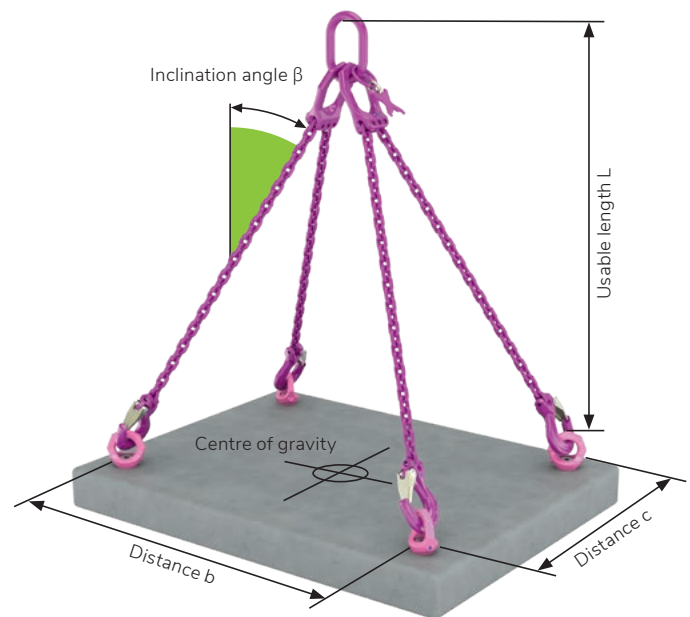

Calculating the suspension correctly.
Use our configuration tool at
www.rud.com



Symmetrical load
Central centre of gravity



Asymmetrical load
Centre of gravity off-centre



Endless chain with load



5. Where is the centre of gravity of the load?

Depending on whether the shape of the load to be lifted is symmetrical or asymmetrical, there are different requirements for the suspension you use. While, for example, a symmetrical load can possibly be lifted with a 1-strand suspension, a suspension with lifting chains of different lengths is usually necessary or at least recommended for an asymmetrical load.

6. Do you want to use an endless chain?

An endless chain can be used, for example, if the load does not have lifting points – in other words, if you have to create lifting points yourself. If you use an endless chain with choke hitch, the WLL of the suspension is reduced by 20%; this has already been taken into account in the information on WLL in this catalogue. However, because of the greater effort involved, you should not use an endless chain if there are other slinging options. Attention: Do not use any lifting gear chains to wrap around loads!

7. What working environment will the suspension be used?

The type of working environment also has an influence over the right choice of suspension components. VIP-Components from RUD (grade 10) allow, for example, operating temperatures between -40 and 200 °C, for ICE-Products (grade 12) they are between -60 and 200 °C (in each case without WLL reduction). In harsh environments, ICE-Components are recommended because of the particularly wear-resistant material. At the same time, because of their lower weight compared to grade 8, ICE-Components offer clear advantages when the lightest possible handling is important.

MISTAKES AND PROHIBITIONS IN THE USE OF SUSPENSIONS.

- Using chains without DGUV approval and tag.
- Combining chains of varying nominal thickness/WLL.
- Knotting chains to shorten them.
- Loading twisted chains.
- Dragging chains over the ground.
- Not protecting chains from loads with sharp edges.
- Using lifting gear chains to wrap around loads.

SELECTION CRITERIA FOR SUSPENSION COMPONENTS: WHAT NEEDS TO BE CONSIDERED?

A series of selection criteria also apply to individual suspension components. Our general recommendation: Always select a suspension according to how and where you want to use it. If you put together several suspensions according to this principle, you act economically and safely at the same time.

MASTER LINKS.

- 1. Size and design of the crane hook.** The sizes of the hooks and master link must correlate. Hooks are available in a range of different sizes. Pay attention to the required size of the master link, as it must be at least 20 % larger than the hook width. There are also hall or mobile crane hooks, single or double crane hooks and many others.
- 2. Weight of the load.** Select the WLL of the master link according to the weight of the load. This information can be found in the product tables in this catalogue.
- 3. Number of strands of the suspension.** The dimension of the master link must fit the required number of strands.

SHORTENING ELEMENTS.

1. Type of shortening.

For rough and fast shortening we recommend the RUD multi-shortening claw. It is captive, yet is integrated in the chains and can be moved. Another advantage: The WLL of the suspension is not reduced with the multi-shortening claw. An alternative is the chain-protecting shortening hook. Both RUD shortening claws and RUD shortening hooks comply with DIN 5692.

The RUD toggle clamp is ideal for precise and infinitely variable length compensation. It is the ideal solution if, for example, the load must be set down exactly horizontally to avoid damage.

2. Handling options.

Of course, the nominal thickness of the suspension must match the shortening element. But it is also important how easily accessible the suspension should be during adjustment. While the RUD shortening hook is firmly mounted in the lifting chain, the multi-shortening claw can be moved in the strand as mentioned above.

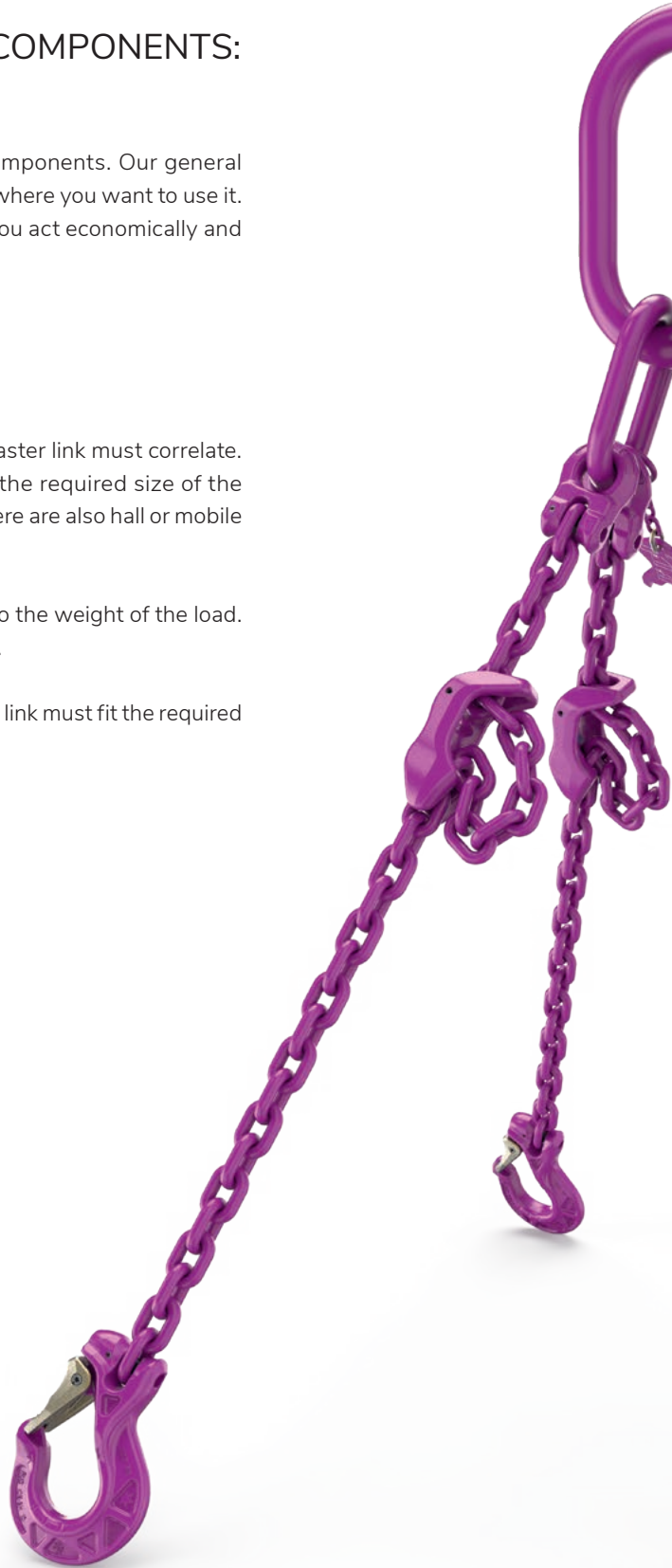



END COMPONENTS.

1. Connection to the lifting means.

Make sure that the lifting chain and the end component of the suspension have the same grade. So do not mix ICE (grade 12) and VIP (grade 10) and certainly do not mix them with other makes. Exceptions: The RUD ICE-CURT-K, which is only available in ICE, can be combined with VIP-Components; however, the WLL of the overall suspension is derived from the grade of the other components. You can also use an H-piece and VIP-Shackles for both VIP- and ICE-Components.

2. Connection to the lifting point on the load.

The end component used must match the type and size of the lifting point. For example, safe lifting is only ensured if the eye of the lifting point lies in the bottom of the hooks, i.e. the hooks are not too large.

3. Type, size and weight of the load.

The WLL of the end component must fit the size and weight of the load. The type of load is also decisive. For example, use the RUD bale hooks for lifting stacked bale hooks.

WHAT ELSE DO YOU NEED TO CONSIDER?

According to DIN EN 818, all components and lifting chains in a suspension must always have the same nominal thickness and the same grade (do not combine ICE and VIP). In addition, components from different manufacturers must not be combined for safety reasons, as the connection systems sometimes differ considerably.

Never apply a load to twisted lifting chains! When lifting, the chains can suddenly untwist and the load can drop down with a jerk. Damage to the chains (until they break) or to the load can be the result of that. Rotate the chains out before lifting (DGUV rule 100-500). Alternatively: Use a RUD swivel adapter from the very beginning.

Never knot chains to shorten them! Otherwise undefined forces and WLL act on individual chain links during lifting. This can lead to dangerous damage to the lifting chains.

If you deflect lifting chains of the suspension at sharp edges, make sure to protect the chain from dangerous damage with an edge protector. Important: The permissible WLL on the chains strand is reduced by 20 % without appropriate edge protection.

USEFUL INFORMATION ABOUT GRADES.

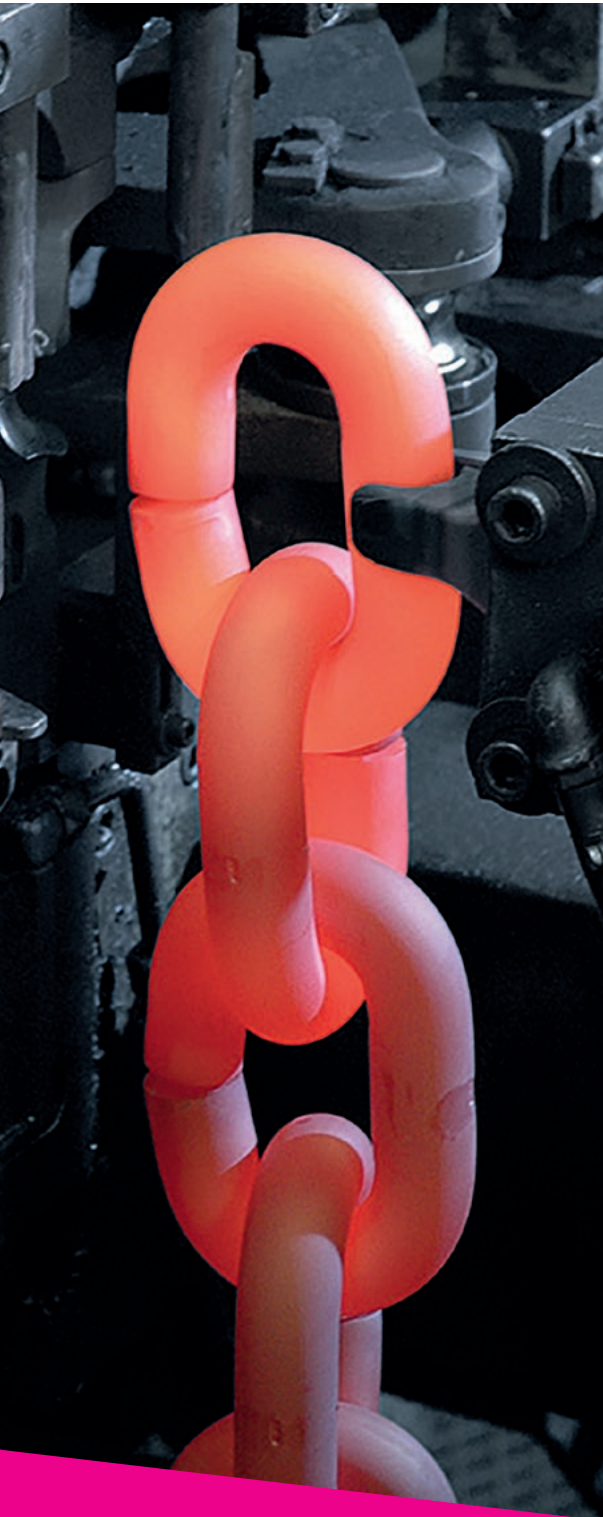

WHAT YOU SHOULD KNOW ABOUT GRADES, MINIMUM BREAKING STRENGTHS AND QUALITY STAMPS.

For lifting chains and other types of chain, the grade is of major importance. In addition to designations such as “G 10”, there is often talk of “quality class 10” or even “grade 100”. However, many people are not aware of the technology behind these designations. This will be explained here more specifically using the example of round steel chains with a diameter of 8 mm.

How are the round steel chains produced?

Round steel chains are bent from a wire section and welded in the middle. The welding bead is then deburred. After welding, the chains are hardened by heating to over 1,000 °C. This changes the structure of the material. This structure, which is responsible for better hardness and strength, should be maintained. To achieve this, the chains are quickly quenched to room temperature.

What is tempering?

The chains are now extremely hard. Depending on the application, it is then tempered again, i.e. heated to over 300 °C. This process is referred to as tempering. Although it reduces the strong hardness it increases the toughness in return and also improves many other properties of the ICE-Chains.

How do you recognise the grade?

In principle, however, you cannot see the grade of chains from the outside. For this reason, chains are already given a quality stamp during production, which clearly defines the grade. In the case of lifting chains, this can be the stamp “(H1) 8” for grade 8 or “(H1) 10” for grade 10. The H stands for “high-strength” and is awarded by the German Social Accident Insurance (DGUV). The number behind the H indicates the manufacturer of the chains. Because RUD was always the first to have chains tested by the DGUV, the 1 always stands for RUD.

For grade 12, the responsible German statutory accident insurance company has issued a completely new stamp “(D)” for certain reasons. This is why RUD was the first manufacturer of round steel chains to receive approval for grade 120 with the stamp (D1) 12 in 2007. These chains are called ICE-Chains at RUD.



How do you determine the grade?

If these pre-calibrated chains are subjected to a tensile load (F), it may only break after reaching the so-called minimum breaking force value. In the case of grade 80, 8 mm chains, this can be the case at $F = 80,000 \text{ N}$ ($80 \text{ kN} \approx 8,000 \text{ kp}$ [kg]). To determine the grade, you need another value: The area of the chains (both wire diameters); this is also called the loaded cross-section.

$$A = \frac{d^2 \times \pi}{4} \times 2$$

For a diameter of 8 mm the smooth value $A = 100 \text{ mm}^2$ results.

$$A = \frac{8 \text{ mm} \times 8 \text{ mm} \times 3.14}{4} \times 2 = 100 \text{ mm}^2$$

The steel strength is technically defined by the value σ_B (Sigma B). It states the force at which a material breaks at a cross-section of 1 mm^2 . This value is called minimum breaking force. It is calculated according to the formula

$$\sigma_B = \frac{F}{A}$$

(Spec. minimum break force.)

Relating to the 8 mm chains, this means: $\sigma_B = 80,000 \text{ N} / 100 \text{ mm}^2 = 800 \text{ N/mm}^2$

$$\sigma_B = \frac{F}{A} = \frac{80,000 \text{ N}}{100 \text{ mm}^2} = 800 \text{ N/mm}^2$$

(Spec. minimum break force.)

800 N corresponds to about 80 kg – grade 8, often called grade 80. If this chain breaks at the same diameter and a force of $100,000 \text{ N} = 10,000 \text{ kp}$ (kg), then we speak of grade 10 or grade 100. These chains are called VIP-Chains at RUD. A grade 12 or grade 120 chain (for RUD this is the ICE-Chain) would therefore break at $120,000 \text{ N}$ or $12,000 \text{ kp}$.

Moreover: Since the characteristics of hoist chains differ considerably from those of lifting chains, hoist chains are stamped with letters rather than numbers to indicate their grade. This should prevent dangerous mix-ups.

ICE- AND VIP-CHAINS: TECHNOLOGIES WITH CRUCIAL ADVANTAGES.

RUD ICE- (grade 12) and VIP-Chains (grade 10) offer you noticeable advantages over grade 8 in all aspects. Their high WLL with comparatively low weight and thus better ergonomics, their high toughness, their durability as well as their increased breaking strength with unchanged elongation at break: All this makes them the economical choice for a wide range of lifting tasks.

HIGH VALUE FOR MONEY THANKS TO SPECIAL HARDENING.

Whether hot or cold: When the ICE- or VIP-Chains are used under rough conditions, the patented material and the special hardening provide clear advantages for the user. This is especially true when handling sectional steel, for example during port handling or during construction operations by chocking. For example, damage to the chains due to edge deflections can be significantly reduced compared to chains with lower strength.

WHAT ICE AND VIP STAND FOR:

- ICE = Innovative Chain Evolution
- VIP = Verwechslungsfrei in Pink (non-mix-up in pink)

GRADE COMPARISON USING SINGLE-STRAND CHAIN AS AN EXAMPLE.



WLL	8 t	8 t
Nominal thickness	13 mm	16 mm
Components	IAK-RG-13 + IMVK-13 ICE-Chain 13 x 39 NL 3,000 mm ICE-STAR hooks 13	AK 1-16 + BSEK Chain 16 x 48 GK8 NL 3,000 mm GSH 16
Weight	20.5 kg = 100 %	27.0 kg = 130 %

WLL	6.7 t	5.3 t
Nominal thickness	13 mm	13 mm
Components	VAK-RG-13 + VMVK-13 VIP-Chain 13 x 39 NL 3,000 mm VCGH 13	AK1-13 + BSEK Chain 13 x 39 GK8 NL 3,000 mm GSH 13
Weight	6.7 t = 125 %	5.3 t = 100 %

HIGHER BREAKING STRENGTH – CONSTANT ELONGATION AT BREAK.

Despite the significantly higher breaking strength of 1,200 or 1,000 N/mm² compared to grade 8 (800 N/mm²), the breaking elongation of the ICE- and VIP-Chains remains the same. It is $\geq 25\%$ in the natural black state, with pink powder coating $\geq 20\%$. The fatigue strength reaches a value of at least 20,000 load cycles (tested at 50 % overload for ICE and VIP).¹

¹ For continuous operation, e.g. in connection with hoists and cranes with high dynamic loads of more than 20,000 load cycles, the WLL must be specified according to EN 818-7 mechanism group 1 Bm (M3) nominal voltage 160 N/mm², i.e. e.g. one chain nominal thickness greater.

SIGNIFICANTLY IMPROVED TOUGHNESS.

In the notched bar impact test it can be determined whether a chain still has sufficient toughness under particularly unfavourable conditions. The result: Compared to chain grade 8 (40 J bei -20 °C), RUD ICE-Chain have 55 J at -60 °C and RUD VIP-Chain have 42 J at -40 °C. These higher values are particularly important for extreme loads.

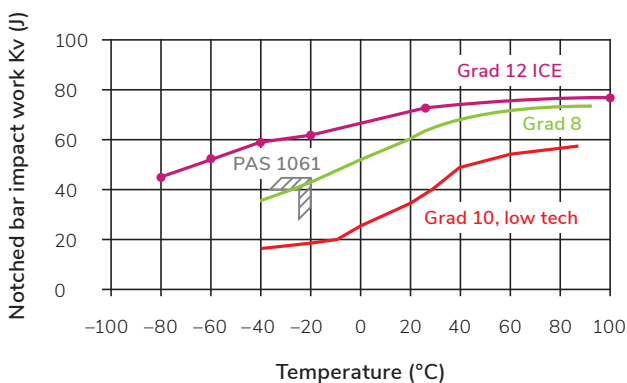

UP TO 60 % HIGHER BREAK FORCE / WLL THAN GRADE 8.

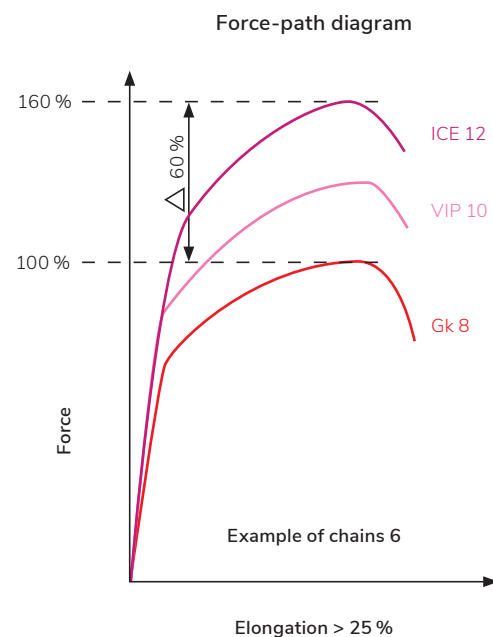

Longer service life thanks to special heat treatment and patented material.

- Higher wear resistance.
- Reduced sensitivity to the penetration of sharp edges.
- 30 % higher surface hardness than grade 8, thus significantly longer service life.

GOOD IDEAS FOR YOUR PLUS IN SAFETY.

Whether great heat or Arctic cold: RUD ICE- and VIP-Chains withstand the highest demands – and that with a comparatively low weight. But even the highest quality chain can reach its limits if it is exposed to unacceptably high temperatures over a long period of time. Thanks to a special coating, you are always on the safe side with ICE- and VIP-Chains.

ICE- AND VIP-CHAINS: SAFETY WITH HEAT INDICATOR.

The special ICE-Pink powder coating permanently signals the highest temperature in which the ICE-Chain has been used to date. In case of prohibited use above 300 °C, the ICE-Pink becomes brown-black. This means: Replace the ICE-Chain.

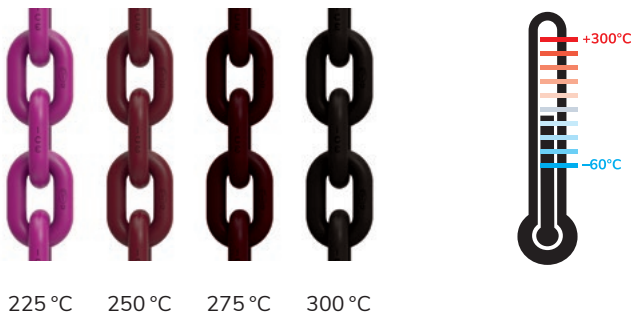

The fluorescent pink powder coating of the VIP-Chain also changes its colour permanently at extreme operating temperatures – in this case at over 200 °C. If the chain is heated inadmissibly above 380 °C, the colour changes to deep black and no small bubbles are formed. The VIP-Chain must then be replaced.

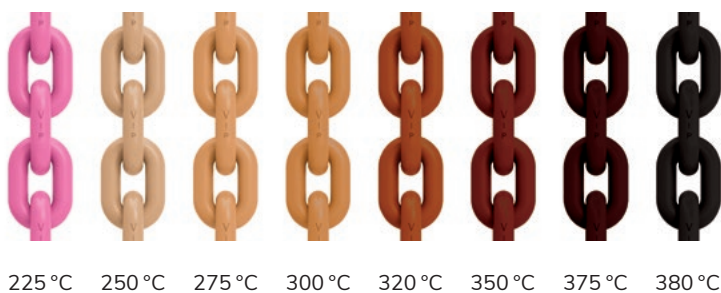

RELIABLY UNMISTAKABLE.

A suspension as a whole only offers maximum application safety if its components are combined in a suitable manner. For example, components of grade 10 (VIP) must not be connected with those of grade 12 (ICE) or with components of other manufacturers. In RUD ICE- and VIP-Components, several safety features ensure that only components of the same grade and WLL can be combined.

NON-MIX-UP ASSEMBLY WITH THE RUD CLEVIS CONNECTION SYSTEM.

Whether ICE or VIP: The dimensional and colour matching of both systems ensures that the correct non-mix-up nominal chains thickness is assigned. An ICE-Connecting bolt (oval design) cannot therefore be combined with other RUD grades – or vice versa. With the VIP-System, only matching VIP-Chains of the correct thickness can be fitted, thanks to the clevis connections, which are non-mix-up. The clevis opening “X” prevents the connection of thicker VIP-Chains, the connecting bolt diameter “Dimension Y” prevents the connection of thinner VIP-Chain.

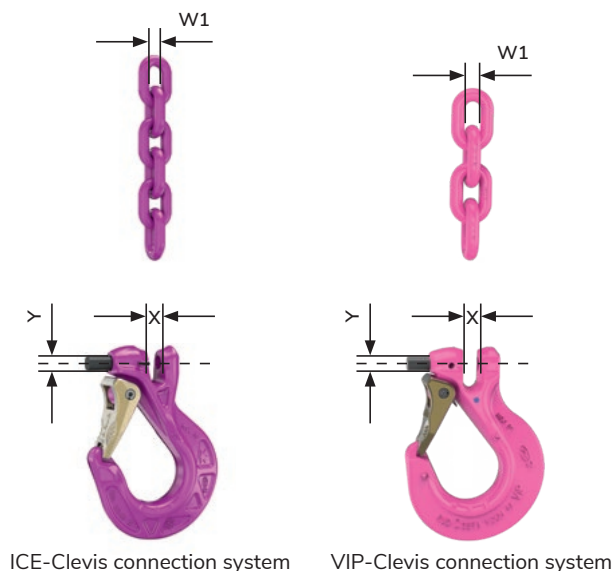

CLEAR EMBOSSING.

All ICE-Chain links and components have a distinct “ICE” embossing by which they can be clearly identified. The same applies to the unmistakable VIP-Embossing of the VIP-Chains and components. This prevents mix-ups with other grades.

THE RUD WELDED CONNECTORS.

The movable welded connectors of the ICE- and VIP-Master links ensure a non-mix-up connection with regard to chains diameter and number of strands. In addition, the master link has an identification tag with integrated patented chains gauge.

PINK POWDER COATING.

VIP- / ICE-Components can be identified by their VIP- / ICE-Pink powder coating, this prevents mix up.

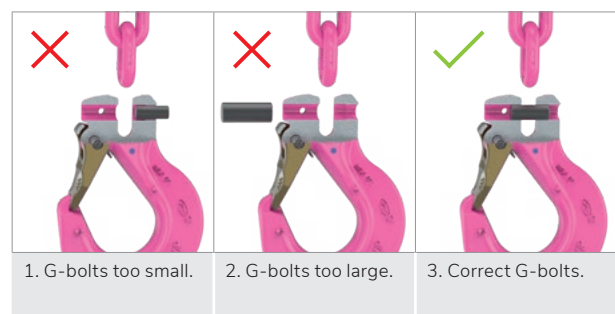

Important note:

RUD ICE- and VIP-Chains (grades 12 and 10) may only be connected with RUD accessories. RUD accepts no liability for ICE- / VIP-Chains and components that are combined with products of other makes. Please pay attention to the operating manual or user info! Only use original RUD spare parts! The DGUV recommends: Chain suspension of grades 12 (ICE) and 10 (VIP) must not be used with chains and components from different manufacturers.

LIGHT AND STRONG: THE ICE-CONSTRUCTION KIT BY RUD.



RUD has always been ahead of its time when it comes to materials for lifting means. One example is the world-famous RUD ICE-Chain, which can replace a grade 8 chain of the next largest nominal thickness. Thanks to the extremely high strength of the patented material, the continuous nominal thickness increase has been achieved even with diameters of less than 16 mm. The decisive advantage: An ICE-Lifting mean or lashing chain is more than 30 percent lighter and the working ergonomics are noticeably improved.

THE ICE-CHAIN TECHNOLOGY FOR 30 % LESS OWN WEIGHT – YOUR ADVANTAGES:

- Better handling through lightweight design: No impairment of health due to too heavy lifting.
- Up to 60 % higher break force / WLL than grade 8.
- Significantly improved toughness and impact energy values (55 J at -60 °C).
- Higher wear resistance and longer life due to special heat treatment and 30 % higher surface hardness.
- Optimum surface protection through special ICE-Pink powder coating.
- Reduced sensitivity to the penetration of sharp edges.
- Environmental protection: significantly less material and less energy consumption in production. Made for extreme temperatures.

HIGH VALUE FOR MONEY THANKS TO SPECIAL ICE-HARDENING.

Whether hot or cold: For tough use of the ICE-Chain, especially when handling sectional steel, such as in port handling or in construction operations with choke hitch, the patented material and the special RUD ICE-Hardening provide clear advantages for the user. This reduces damage to the chain caused by edge deflection compared to a chain with lower strength.

THE DECISIVE ICE-ADVANTAGES: ALWAYS A NOMINAL THICKNESS LOWER THAN GRADE 8.

Nominal thickness mm	WLL kg	
	Grade 8	ICE 120
6	-	1,800
8	2,000	3,000
10	3,150	5,000
13	5,300	8,000
16	8,000	12,500
20	12,500	-



RUD LIFTING MEANS IN VIP-QUALITY.



Innovation and quality made by RUD: The highly dynamic chains and components of RUD product line VIP stand for up to 30 percent higher WLL than the highest grade 8 (grade 80) available until then. And with the same chains diameter. VIP-Chains from 18 mm are always one nominal thickness thinner – and therefore up to 50 percent lighter. The geometric structure and the tolerances of the VIP-Chains are adapted to those of the higher grade. The chain spectrum ranges from 4 to 28 mm and from 0.63 t (MINI single-strand) to 126 t (2 x MAXI double-strand).

RUD LIFTING MEANS IN GRADE 10 (VIP) – THE CONVINCING ADVANTAGES:

- Up to 30 % higher WLL than grade 8 (grade 80) with the same chain diameter (Ø 16, 20, 22 and 28 mm in grade 10 (VIP) replace Ø 18, 22, 26 and 32 mm in grade 8).
- Noticeable weight savings –better handling.
- Dynamic strength considerably higher than standard values.
Minimum number of load cycles: > 20,000, with an upper load of 1.5 times the VIP WLL.
- High toughness due to specially tempered CrNiMo stainless steel.
- Notch insensitivity and hydrogen embrittlement resistance like grade 8.
- Duplex surface protection: Pre-treatment plus pink powder coating (Super corrosion coating Corrud® DS on request).
- Longer service life, because of special RUD heat treatment process less sensitive to abrasion and damage.
- Production and lot numbers are stamped at regular intervals on the chain links stamped – for complete proof of the production and test data.



More and more RUD VIP-Products have the important DNVGL approval. This makes them ideally suitable for use in the marine and offshore sector.



IMPORTANT NOTE.

VIP-Chains 8S or 10 may only be connected with RUD accessories. RUD accepts no liability for VIP-Chains and VIP-Components that are combined with products of other makes. Please pay attention to the operating manual or user info! Only use original RUD spare parts! The DGUV recommends: Chain suspensions of grade 10 must not be used with chains and components from different manufacturers.

SIMPLE PRODUCT INSPECTING WITH RFID TECHNOLOGY.



THE RUD BLUE-ID SYSTEM: IDENTIFY. TRANSMIT. MANAGE.

From RDIF transponders and readers to a documentation and management software: With the RUD BLUE SYSTEM, we offer you a comfortable overall solution for inspecting your equipment. This noticeably relieves your daily workload and saves costs.

The wireless and safe transmission via RFID transponders makes the product identification more convenient than ever. And with our readers and the software solution, documentation and administration also become incredibly easy. Thus, with a single click, all RUD components with RFID tags can be identified contact-free and without errors and transmitted directly to the software or app for further processing of the test data. It could not be more convenient or more secure. Your entire inspecting process will be simpler, faster and more reliable. This gives you more time for your core business.

THE RUD BLUE-ID SYSTEM.

- Lower inspection costs, time and personnel expenditure.
- More process and legal security (avoidance of errors).
- Factory preassigned product information simple, contact-free and fast readout on site.
- Clear marking and identification of the products with RFID technology.
- Offline inspecting possible without Internet access.
- Simple documentation and administration of test data with the cloud based software solution AYE-D.NET.



Fitted as standard in defined RUD products.
Can be retrofitted for many other products.



If you see this symbol next to the image of an RUD product, you know: An RFID transponder is installed here.

THE HARDWARE. FLEXIBLE, ADAPTABLE, RESISTANT.



RFID transponders are already integrated as standard in defined RUD products. In addition, we offer you numerous possibilities to retrofit components safely and permanently with one of our transponders. Each of them is extremely resistant and can withstand even the harshest environmental conditions such as extreme temperatures or chemically aggressive substances.



The RUD ID-POINT®.
The press-fit version.



The RUD ID-STICKER.
The glue version.



The RUD ID-TAG®.
The clip version.



The RUD ID-USB-READER.



The RUD ID-LINK®.
The sagging version.



THE SOFTWARE. HIGH-PERFORMANCE, MODULAR, SIMPLE TO USE.

As a combination of inspecting, administration and documentation software, AYE-D.NET opens up numerous possibilities in inspecting administration and subsequent processes. We offer the cloud-based software tool as a SaaS solution together with our partner Syfit. Alternatively, you can organise the test documentation with existing databases and standard programmes such as Office applications, SAP etc.







RUD LIFTING MEANS
IN ICE- AND VIP-QUALITY.





WLL AT A GLANCE.

Grades 8, 10 (VIP) and 12 (ICE) WLL of lifting chains in "t".
Corresponding angle of inclination with symmetrical load.

TYPES OF ATTACHMENT		1-STRAND	2-STRAND		3- AND 4-STRAND		ENDLESS ² Endless chain with choke hitch	
								
Inclination angle: β		0	0-45°	> 45-60°	0-45°	> 45-60°	-	
Load factor		1.0	1.4	1.0	2.1	1.5	1.6	
Chains \emptyset	Grade							
Ø 4	VIP	0.63	0.88	0.63	1.32	0.95	1.0	
	ICE	0.80	1.12	0.80	1.70	1.18	1.25	
Ø 6	Grade 8	1.12	1.6	1.12	2.36	1.7	1.8	
	VIP	1.5	2.1	1.5	3.15	2.25	2.4	
	ICE	1.8	2.52	1.8	3.75	2.7	2.88	
Ø 8	Grade 8	2.0	2.8	2.0	4.25	3.0	3.15	
	VIP	2.5	3.5	2.5	5.25	3.75	4.0	
	ICE	3.0	4.25	3.0	6.3	4.5	4.8	
Ø 10	Grade 8	3.15	4.25	3.15	6.7	4.75	5.0	
	VIP	4.0	5.6	4.0	8.4	6.0	6.4	
	ICE	5.0	7.1	5.0	10.6	7.5	8.0	
Ø 13	Grade 8	5.3	7.5	5.3	11.2	8.0	8.5	
	VIP	6.7	9.5	6.7	14.1	10.0	10.6	
	ICE	8.0	11.2	8.0	17.0	11.8	12.8	
Ø 16	Grade 8	8.0	11.2	8.0	17.0	11.8	12.5	
	VIP	10.0	14.0	10.0	21.2	15.0	16.0	
	ICE	12.5	17.0	12.5	26.5	19.0	20.0	
Ø 18	Grade 8	10.0	14.0	10.0	21.2	15.0	16.0	
Ø 20	Grade 8	12.5	17.0	12.5	26.5	19.0	20.0	
	VIP	16.0	22.4	16.0	33.6	24.0	25.6	
Ø 22	Grade 8	15.0	21.2	15.0	31.5	22.4	23.6	
	VIP	20.0	28.0	20.0	42.0	30.0	32.0	
Ø 26	Grade 8	21.2	30.0	21.2	45.0	31.5	33.5	
Ø 28	VIP	31.5	45.0	31.5	67.0 ¹	47.5 ¹	50.0	
Ø 32	Grade 8	31.5	45.0	31.5	67.5	47.5	50.0	

¹ Only available as a 2 x 2-strand version.

² 20 % reduction for endless chains (sharp edges) is taken into account!
Subject to technical changes!

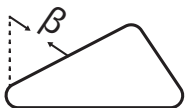

Attention:

According to DGUV rule 100-500 chapter 2.8, the single strand WLL applies in the event of asymmetrical loading of a multiple strand suspension.

	ENDLESS CHAIN ²				CHOKE HITCH ²		
	SINGLE		DOUBLE		SINGLE	DOUBLE	
	0	> 45-60°	0-45°	> 45-60°	0	0-45°	> 45-60°
	1.1	0.8	1.7	1.2	0.8	1.1	0.8
	0.69	0.5	1.1	0.75	0.5	0.69	0.5
	0.88	0.64	1.36	0.96	0.64	0.88	0.64
	1.2	0.9	1.9	1.3	0.9	1.2	0.9
	1.65	1.2	2.55	1.8	1.2	1.65	1.2
	2.0	1.44	3.1	2.1	1.44	2.0	1.44
	2.2	1.6	3.4	2.4	1.6	2.2	1.6
	2.75	2.0	4.25	3.0	2.0	2.75	2.0
	3.3	2.4	5.1	3.6	2.4	3.3	2.4
	3.5	2.5	5.3	3.8	2.5	3.5	2.5
	4.4	3.2	6.8	4.8	3.2	4.4	3.2
	5.5	4.0	8.5	6.0	4.0	5.5	4.0
	5.8	4.0	9.0	6.0	4.0	5.8	4.0
	7.5	5.3	11.2	8.0	5.3	7.5	5.3
	8.8	6.4	13.6	9.6	6.4	8.8	6.4
	8.8	6.4	13.6	9.6	6.4	8.8	6.4
	11.0	8.0	17.0	12.0	8.0	11.0	8.0
	14.0	10.0	21.2	15.0	10.0	14.0	10.0
	11.0	8.0	17.0	12.0	8.0	11.0	8.0
	14.0	10.0	21.2	15.0	10.0	14.0	10.0
	17.6	12.8	27.2	19.2	12.8	17.6	12.8
	16.5	12.0	25.5	18.0	12.0	16.5	12.0
	22.0	16.0	34.0	24.0	16.0	22.0	16.0
	23.3	17.0	36.0	25.4	17.0	23.0	17.0
	35.5	25.0	53.0 ¹	37.5 ¹	25.0	35.5	25.0
	35.5	25.0	53.0	37.5	25.0	35.5	25.0

Temperature °C / °F	Grade 8	-40° to +200 °C (-40° to +392 °F)	Above 200° to 300 °C (Above 392° to 572 °F)	Above 300° to 400 °C (Above 572° to 752 °F)
				100 %
	VIP 10	-40° to +200 °C (-40° to +392 °F)	Above 200° to 300 °C (Above 392° to 572 °F)	Above 300° to 380 °C (Above 572° to 716 °F)
		100 %	90 %	60 %
	ICE 12	-60° to +200 °C (-76° to +392 °F)	Above 200° to 250 °C (Above 392° to 482 °F)	Above 250° to 300 °C (Above 482° to 572 °F)
		100 %	90 %	60 %

ICE-CONSTRUCTION KIT.





OVERVIEW
ICE-CONSTRUCTION KIT PART 1.

			4:1		-XX° XXX° C	XXX° C max.	BLUE-ID 	DGUV TEST	DNVGL TEST
			Safety factor 4:1	100% electromagnetically crack-tested	Application temperature range without WLL reduction	Max. application temperature with WLL reduction	RUD BLUE-ID SYSTEM	DGUV approval	Certified according to the DNVGL guideline
CHAINS									
p. 40		ICE-Lifting means 0.8t-12.5t	■	■	■	■		■	
p. 41		ICE-KZA Identification tag							
MASTER LINKS									
p. 42		IAK-RG-1 / -RG-2 / -RG-4 1.8t-12.5t/2.5t-17.5t/3.75t-26.5t	■	■	■	■	■	■	■
p. 42		IBK-RG-1 / -RG-2 1.8t-12.5t/2.5t-17.0t	■	■	■	■	■	■	■
p. 44		ISAK-RG-1 / -RG-2 / -RG-4 1.8t-12.5t/2.5t-17.0t/3.75t-26.5t	■	■	■	■	■	■	■
CONNECTING AND SHORTENING ELEMENTS									
p. 46		IVS 1.8t-12.5t	■	■	■	■	■	■	■
p. 47		IVH 1.8t-12.5t	■	■	■	■	■	■	■
p. 48		IH ICE-H-CONNECTOR 0.8t-12.5t	■	■	■	■	■	■	■
p. 49		IMVK 1.8t-12.5t	■	■	■	■	■	■	■
p. 50		IW 3.75t-35.0t	■	■	■	■	■	■	■
p. 52		ICE-CURT-K 1.8t-12.5t	■	■	■	■	■	■	■

ICE-CONSTRUCTION KIT.





OVERVIEW
ICE-CONSTRUCTION KIT PART 2.

			4:1		-XX° XXX° C	XXX° C max.	BLUE-ID 	DGUV TEST	DNVGL TEST
			Safety factor 4:1	100% electromagnetically crack-tested	Application temperature range without WLL reduction	Max. application temperature with WLL reduction	RUD BLUE-ID SYSTEM	DGUV approval	Certified according to the DNVGL guideline
END COMPONENTS									
p. 53		ISH 0.8t-12.5t	■	■	■	■	■	■	
p. 54		IWH 1.8t-12.5t	■	■	■	■	■	■	
p. 55		IMEG 5.0t-8.0t	■	■	■	■	■	■	
p. 56		IAGH 1.8t-12.5t	■	■	■	■	■	■	
p. 57		IMAGH 5.0t-8.0t	■	■	■	■	■	■	
p. 58		IRG 1.8t-12.5t	■	■	■	■	■	■	
ICE-MINI CONSTRUCTION KIT, p. 60-61									
ICE-SPARE PARTS, p. 62-63									

OPTIMAL COMBINATIONS.

ICE-Master links: non-mix-up with ICE-Welded connectors.

	IAK-RG 1 / IBK-RG 1	IAK-RG 2 / IBK-RG 2	IAK-RG 4	ISAK-RG (1- / 2- / 4-strand)
1-strand				Suspension not shortened.
				Suspension shortened with ICE-shortening hook IVH.
				Suspension shortened with ICE-multi-shortening claw IMVK.

END COMPONENTS								
IB-RG	IA-RG	ISH	IAGH / IM-AGH	IWH	IMEG	IVH	IVS	IRG

ICE-DESIGN OR DESIGNATION EXAMPLE – COMPLETE SUSPENSION.

	Grade	Number of strands	Master link	Shortening / strands	Shortening / component	End component	Chains	Required usable length (mm) – not shortened
	ICE	G1	(IBK)	1	IMVK	ISH	13	2,000
ICE-G1 (IBK)-IMVK-ISH / 13 x 2,000								

OPTIMAL COMBINATIONS.

ICE-Combination options | Endless chain.

	IAK-RG 2 / IBK-RG 2	IAK-RG 4		ISAK-RG (2- / 4-strand)
				140 190 250
Single			Endless	Endless chain with ICE-H-Connector IH.
				Endless chain shortened with ICE-shortening hook IVH.
Double			Endless	Endless chain shortened with ICE-multi-shortening claw IMVK.

Excellent ergonomics.

Thanks to their reduced weight, measured against the comparatively high WLL, the products of the RUD ICE-Modular system offer clear advantages in terms of ergonomics.

Handling:

RUD ICE-Chains and components (grade 12) may not be combined with chains and components of other manufacturers or other grades. Attention: Incorrect handling and use of these lifting chains can lead to material and / or personal damage!

Important safety information must be observed:

DIN-EN 818, DIN-EN 1677, DGUV rule 100-500 (BGR 500) EU Machinery Directive 2006 / 42 / EC, manufacturer usage information, BGI 556 / DGUV information 209-013.

We assume no responsibility for damages caused by disregarding these standards and safety information.

ICE-DESIGN OR DESIGNATION EXAMPLE – COMPLETE SUSPENSION.

	Grade	Endless chain	Single (E) / double (D)	Number of shortenings	Shortening / component	Chains	Required usable length (mm) – not shortened
	ICE	KR	(E)	1	(IVH)	8	2,000
ICE-KRE (IVH)-8 x 2,000							

ICE-LIFTING MEANS



ICE-Lifting means in grade 12.

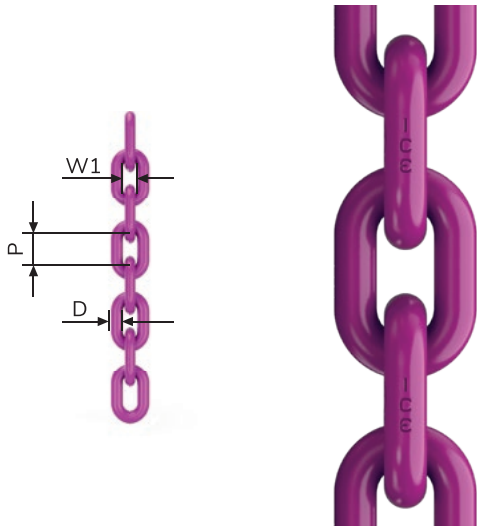

PRODUCT FEATURES

- ICE-Round steel chains are made from a patented material and they are specially hardened. They are high strength and toughness. They are designed according to DIN EN 818 and 1677 for a dynamic load of 20,000 load cycles (tested at 50 % overload).
- The approval of RUD grade 12 by the responsible DGUV is documented at short intervals with the embossed identification stamp "D1-12".
D = "Degree of Quality".
1 means manufacturer number 1 = RUD.
12 means grade 12 accordingly.

D = nominal thickness [mm Ø]	4	6	8	10	13	16
P = division [mm]	12.0	18.0	24.0	30.0	39.0	48.0
W1 = inner width [bi min. mm]	5.2	7.8	10.4	13.0	17.0	21.0
WLL [t]	0.8	1.8	3.0	5.0	8.0	12.5
Test force MPF min. kN	19.6	44.1	73.5	123.0	196.0	314.0
Test force BF min. kN	31.4	71.0	118.0	196.0	314.0	503.0
Weight [kg/pc.]	0.44	0.98	1.66	2.62	4.25	6.72
Order no. ICE-Pink	7904694	7998048	7996116	7996117	7996118	7998735
Order no. phosphated natural black	7905283	7905284	7905285	7905286	7905287	7905288

Subject to technical changes!

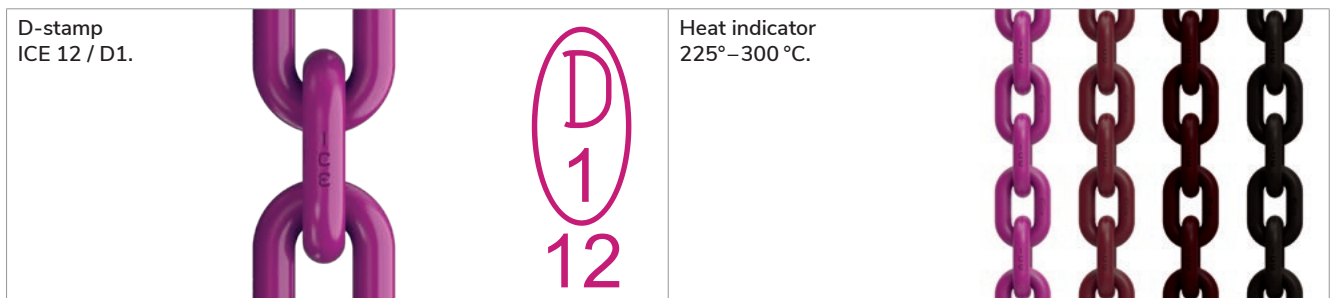

More information on page 24.

- Elongation at break:
A min.: natural black $\geq 25\%$, ICE-Pink $\geq 20\%$
- Stamping: ICE-Marking on the back of each chain link, production number and DGUV approval stamp < 0.5 m

ICE-KZA

Identification tag.

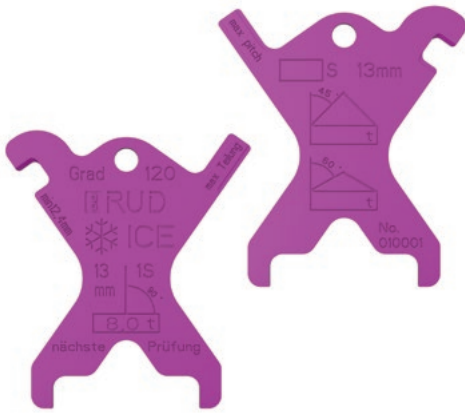

ICE-IDENTIFICATION TAG AS CHAIN GAUGE ¹.

Chains	Designation	Order no.
4	IKPL-4	7904970
6	IKPL-6	7998167
8	IKPL-8	7995525
10	IKPL-10	7995521
13 ¹	IKPL-13	7995530
16 ¹	IKPL-16	7998949

¹ Universal from size 13. Included separately with each master link. More information on pages 120–121.

Subject to technical changes!

ICE-IDENTIFICATION TAG WITH INTEGRATED CHAIN GAUGE.

Chains	Designation	Single strand	Double strand	3-/4-strand	Without WLL stamp
4	IKZA-...strand-4	7905223	7905223	7906302	-
6	IKZA-...strand-6	7998743	7998744	7998745	7998736
8	IKZA-...strand-8	7996286	7996287	7996288	7995552
10	IKZA-...strand-10	7996289	7996290	7996291	7995553

Subject to technical changes!



ICE-IDENTIFICATION TAG IKZA (UNIVERSAL SIZE).

Chains	Designation	Single strand	Double strand	3-/4-strand	Universal KZA without WLL stamp
13	IKZA-...Strg-13	7902488	7902489	7902490	7901059
16	IKZA-...Strg-16	7902491	7902492	7902493	7901059

Subject to technical changes!



Inspecting \varnothing wear occurrence.

Inspecting plastic elongation due to overload.

Inspecting the division extension by nominal thickness wear occurrence.

More information on pages 120–121.

IAK-RG-1 / -RG-2 / -RG-4



ICE-Standard master links with welded-in connectors.



PRODUCT FEATURES

- All master links on this page are equipped with welded-in connectors that can be moved on all sides.
- This results in a non-mix-up connection to chain diameter and number of strands.
- The master link is supplemented with an identification tag (KZA) with integrated chain test gauge.
- IAK-RG master links: The dimensions correspond with suspension link shape A according to DIN 5688 but one nominal thickness larger.
- IBK-RG master links: The inner width is adequate for hanging on high-strength load hooks on lifting gear.

IAK-RG-1 AND IBK-RG-1 MASTER LINK / END LINK WITH WELDED-IN CONNECTIONS.

Chains	WLL [t]	Designation	Ø A	B	C	T	Weight [kg/pc.]	Order no.
4	0.8	IAK-1 / 2-4	13	34	38	58	0.2	7905031
6	1.8	IAK-RG-1-6 (IA-RG-1-6)	13	60	110	144	0.57 (0.5)	7903009 (7903090)
8	3.0	IAK-RG-1-8 (IA-RG-1-8)	16	75	135	178	1.04 (0.9)	7903010 (7903091)
10	5.0	IAK-RG-1-10 (IA-RG-1-10)	22	90	160	213	2.19 (2.0)	7903011 (7903092)
13	8.0	IAK-RG-1-13 (IA-RG-1-13)	26	100	180	247	3.58 (3.4)	7903012 (7903093)
16	12.5	IAK-RG-1-16 (IA-RG-1-16)	32	140	260	343	7.2 (7.0)	7903013 (7903094)
6	1.8	IBK-RG-1-6 (IB-RG-1-6)	13	34	70	105	0.43 (0.35)	7903041 (7903095)
8	3.0	IBK-RG-1-8 (IB-RG-1-8)	18	40	85	129	0.92 (0.8)	7903042 (7903096)
10	5.0	IBK-RG-1-10 (IB-RG-1-10)	22	50	115	169	1.76 (1.5)	7903043 (7903097)
13	8.0	IBK-RG-1-13 (IB-RG-1-13)	26	65	140	207	3.0 (2.8)	7903044 (7903098)
16	12.5	IBK-RG-1-16 (IB-RG-1-16)	32	75	170	253	5.5 (5.3)	7903045 (7903099)

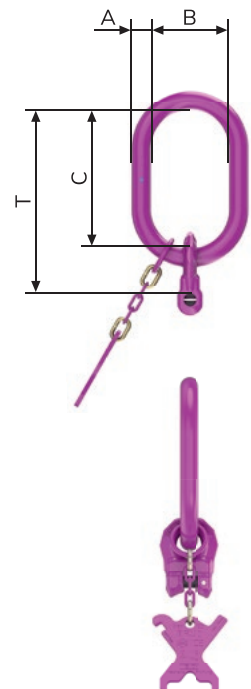

Subject to technical changes!

- ICE-Connection bolts and safety pin are pre-assembled.
- Also available as end link IA-RG-1 without identification tag.
- For detailed information on ICE-MINI 4 mm see page 60–61.

IAK-RG-2- AND IBK-RG-2-STRAND MASTER LINK WITH TWO WELDED-IN CONNECTORS.

Chains	WLL [t]	Designation	Ø A	B	C	T	Weight [kg/pc.]	Order no.
4	1.12/0.8	IAK-1/2-4	13	34	38	58	0.2	7905031
6	2.5/1.8	IAK-RG-2-6	16	75	135	171	1.0	7903051
8	4.25/3.0	IAK-RG-2-8	22	90	160	203	2.1	7903052
10	7.1/5.0	IAK-RG-2-10	26	100	180	233	3.5	7903053
13	11.2/8.0	IAK-RG-2-13	32	110	200	267	6.3	7903054
16	17.0/12.5	IAK-RG-2-16	36	180	340	423	11.3	7903055
6	2.5/1.8	IBK-RG-2-6	13	34	70	105	0.65	7903075
8	4.25/3.0	IBK-RG-2-8	18	40	85	129	1.5	7903076
10	7.1/5.0	IBK-RG-2-10	22	50	115	169	2.14	7903077
13	11.2/8.0	IBK-RG-2-13	26	65	140	207	5.1	7903078
16	17.0/12.5	IBK-RG-2-16	32	75	170	253	9.0	7903079

Subject to technical changes!

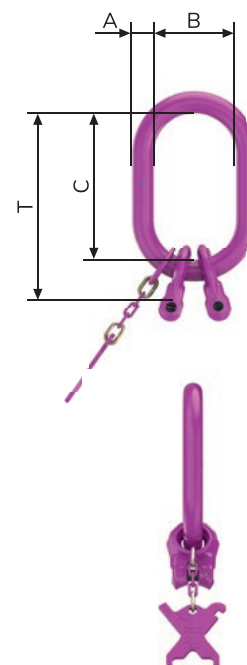

IAK-RG-4-STRAND MASTER LINK WITH 4 WELDED CONNECTOR WELDED INTO 2 INTERMEDIATE LINKS.

Chains	WLL [t]	Designation	Ø A	B	C	Ø D	E	F	T	Weight [kg/pc.]	Order no.
4	1.7/1.18	IAK-3/4-4	10	35	60	-	-	-	120	0.53	7905033
6	3.75/2.7	IAK-RG-4-6	18	90	160	13	34	70	265	2.04	7903085
8	6.3/4.5	IAK-RG-4-8	26	100	180	18	40	85	309	4.59	7903086
10	10.6/7.5	IAK-RG-4-10	32	110	200	22	50	115	369	8.37	7903087
13	17.0/11.8	IAK-RG-4-13	36	140	260	26	65	140	467	14.44	7903088
16	26.5/19.0	IAK-RG-4-16	46	190	350	32	75	170	603	28.87	7903089

Subject to technical changes!

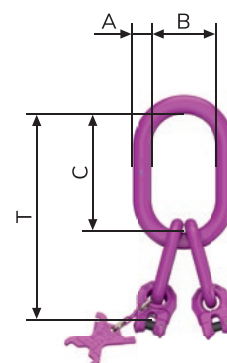

SELECTION TABLE FOR CRANE HOOK SIZES ¹.

Size	6	8	10	13	16
IAK-RG 1	No. 2.5	No. 5	No. 6	No. 8	No. 16
IAK-RG 2	No. 5	No. 6	No. 8	No. 10	No. 25
IAK-RG 4	No. 6	No. 8	No. 10	No. 16	No. 32

¹For single crane hooks DIN 15401.

Subject to technical changes!

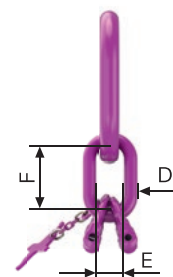

ISAK-RG-1 / -RG-2 / -RG-4



ICE-Special master links with welded-in connectors.



PRODUCT FEATURES

- All special master links on this page are equipped with welded-in connectors that can be moved on all sides.
- This results in a non-mix-up connection to chain diameter and number of strands.
- The master link is supplemented with an identification tag (KZA) with integrated chain test gauge.
- The larger gradation of the inner width "B" prevents an unauthorised application (BGR 500 / DGUV rule 100-500 section 2.8) and reduces wear occurrence on the crane hook.
- **Attention:** Master links size 13 and 16 have special identification tags. A test tag is additionally enclosed for master links 13 and 16!

ISAK-RG-1-STRAND MASTER LINK

WITH WELDED CONNECTOR WELDED INTO THE INTERMEDIATE LINK.

Chains	WLL [t]	Designation	Ø A	B	C	Ø D	E	F	T	Weight [kg/pc.]	Order no.
6	1.8	ISAK-RG-1-6 / 140	18	140	260	13	34	70	365	2.29	7903182
8	3.0	ISAK-RG-1-8 / 140	22	140	260	18	40	85	389	3.94	7903183
10	5.0	ISAK-RG-1-10 / 140	26	140	260	22	50	115	429	6.34	7903184
13	8.0	ISAK-RG-1-13 / 140	32	140	260	26	65	140	467	9.44	7903185
6	1.8	ISAK-RG-1-6 / 190	22	190	350	13	34	70	455	3.82	7903186
8	3.0	ISAK-RG-1-8 / 190	26	190	350	18	40	85	479	6.03	7903187
10	5.0	ISAK-RG-1-10 / 190	32	190	350	22	50	115	519	10.02	7903188
13	8.0	ISAK-RG-1-13 / 190	36	190	350	26	65	140	557	13.90	7903189
8	3.0	ISAK-RG-1-8 / 250	36	250	460	18	40	85	589	12.86	7903190
10	5.0	ISAK-RG-1-10 / 250	36	250	460	22	50	115	629	14.32	7903191
13	8.0	ISAK-RG-1-13 / 250	36	250	460	26	65	140	667	16.33	7903192
16	12.5	ISAK-RG-1-16 / 250	40	250	460	32	75	170	713	23.14	7903193

Subject to technical changes!

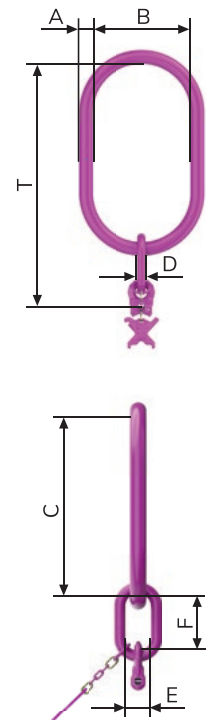

- ICE-Connection bolts and safety latch are pre-assembled.

**ISAK-RG-2-STRAND MASTER LINK
WITH 2 WELDED CONNECTORS WELDED INTO 1 INTERMEDIATE LINK.**

Chains	WLL [t]	Designation	Ø A	B	C	Ø D	E	F	T	Weight [kg/pc.]	Order no.
6	2.5/1.8	ISAK-RG-2-6/140	18	140	260	13	34	70	365	2.36	7903194
8	4.25/3.0	ISAK-RG-2-8/140	22	140	260	18	40	85	389	4.03	7903195
10	7.1/5.0	ISAK-RG-2-10/140	26	140	260	22	50	115	429	6.63	7903196
13	11.2/8.0	ISAK-RG-2-13/140	32	140	260	26	65	140	467	10.47	7903197
6	2.5/1.8	ISAK-RG-2-6/190	22	190	350	13	34	70	455	3.89	7903198
8	4.25/3.0	ISAK-RG-2-8/190	26	190	350	18	40	85	479	6.13	7903199
10	7.1/5.0	ISAK-RG-2-10/190	32	190	350	22	50	115	519	10.30	7903200
13	11.2/8.0	ISAK-RG-2-13/190	36	190	350	26	65	140	557	14.93	7903201
8	4.25/3.0	ISAK-RG-2-8/250	36	250	460	18	40	85	589	12.95	7903202
10	7.1/5.0	ISAK-RG-2-10/250	36	250	460	22	50	115	629	14.61	7903203
13	11.2/8.0	ISAK-RG-2-13/250	36	250	460	26	65	140	667	17.37	7903204
16	17.0/12.5	ISAK-RG-2-16/250	40	250	460	32	75	170	713	25.16	7903205

Subject to technical changes!

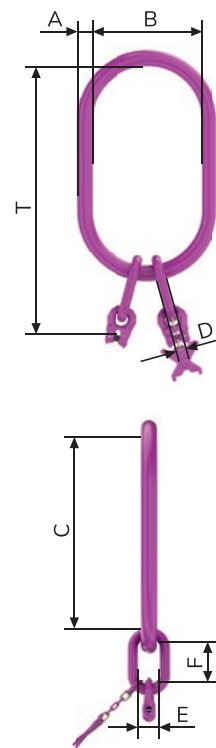

**ISAK-RG-4-STRAND MASTER LINK
WITH 4 WELDED CONNECTOR WELDED INTO 2 INTERMEDIATE LINKS.**

Chains	WLL [t]	Designation	Ø A	B	C	Ø D	E	F	T	Weight [kg/pc.]	Order no.
6	3.75/2.7	ISAK-RG-4-6/140	22	140	260	13	34	70	365	3.24	7903206
8	6.3/4.5	ISAK-RG-4-8/140	26	140	260	18	40	85	389	5.47	7903207
10	10.6/7.5	ISAK-RG-4-10/140	32	140	260	22	50	115	429	9.7	7903208
6	3.75/2.7	ISAK-RG-4-6/190	26	190	350	13	34	70	455	5.34	7903209
8	6.3/4.5	ISAK-RG-4-8/190	32	190	350	18	40	85	479	9.14	7903210
10	10.6/7.5	ISAK-RG-4-10/190	36	190	350	22	50	115	519	13.16	7903211
13	17.0/11.8	ISAK-RG-4-13/190	40	190	350	26	65	140	557	19.14	7903212
8	6.3/4.5	ISAK-RG-4-8/250	36	250	460	18	40	85	589	13.45	7903213
10	10.6/7.5	ISAK-RG-4-10/250	36	250	460	22	50	115	629	15.6	7903214
13	17.0/11.8	ISAK-RG-4-13/250	40	250	460	26	65	140	667	22.12	7903215
16	26.5/19.0	ISAK-RG-4-16/250	47	250	460	32	75	170	713	32.98	7903216

Subject to technical changes!

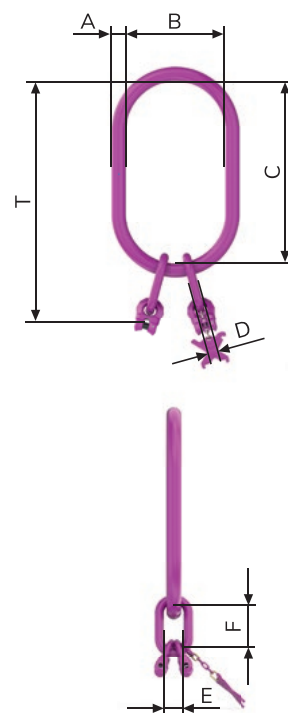

SELECTION TABLE FOR CRANE HOOK SIZES ¹.

ISAK-RG dimension B = 140	No. 16
ISAK-RG dimension B = 190	No. 32
ISAK-RG dimension B = 250	No. 50

¹ For single crane hooks DIN 15401.

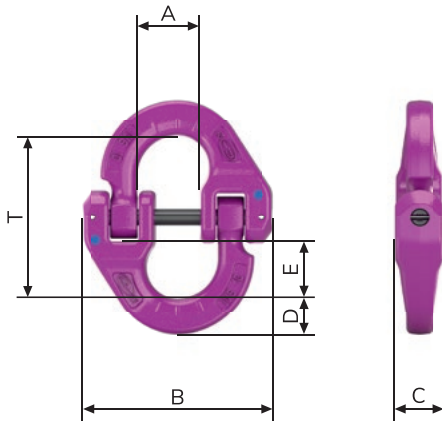

PRODUCT FEATURES

- External connections, e.g. lifting points, shackles, lifting clamps and the chains can be fitted in the lock bracket halves.
- Shape and function registered for patent.
- No kinking of the assembled chain possible.
- The bracket halves can be combined with each other in any way.
- No wandering, no damage to the otherwise usual safety spring or the sleeves of the retaining bolt.
- Patented wear occurrence marks.

Chains	WLL [t]	Designation	A	B	C	D	E	T	Weight [kg/pc.]	Order no.
6	1.8	IVS-6	18	56	13	11	17	46	0.12	7901471
8	3.0	IVS-8	24	70	17.5	14	23	61	0.29	7901472
10	5.0	IVS-10	28	88	22	17	27	74	0.6	7901473
13	8.0	IVS-13	34	111	28	23	33	93	1.2	7901474
16	12.5	IVS-16	39	130	33	27	37	108	2.0	7901475

Subject to technical changes!

Designation	IVS connection to suit VIP-Shackles
IVS-6	VV-SCH 8 – 2.5 t to VV-SCH 13 – 6.7 t
IVS-8	VV-SCH 10 – 4 t to VV-SCH 16 – 10 t
IVS-10	VV-SCH 13 – 6.7 t to VC-SCH 4.0 – 16 t
IVS-13	VV-SCH 16 – 10 t to VC-SCH 5.0 – 25 t
IVS-16	VC-SCH 4 – 14 t to VC-SCH 6.0 – 28.0 t

Subject to technical changes!

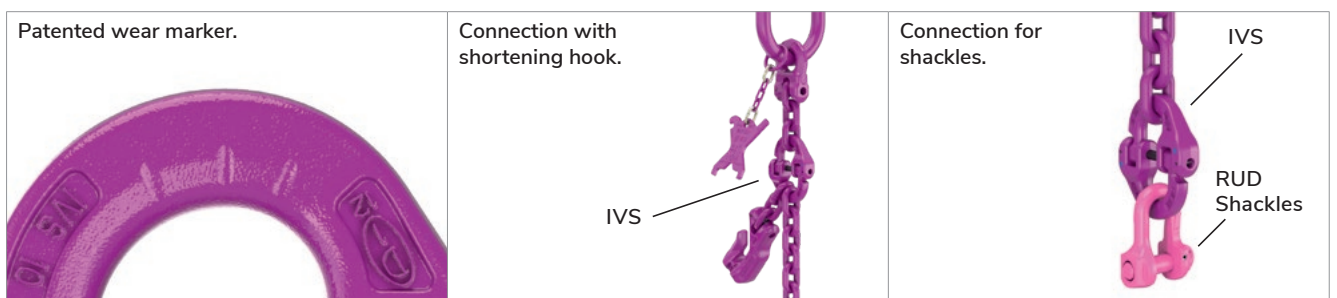

IVH

ICE-shortening hook.

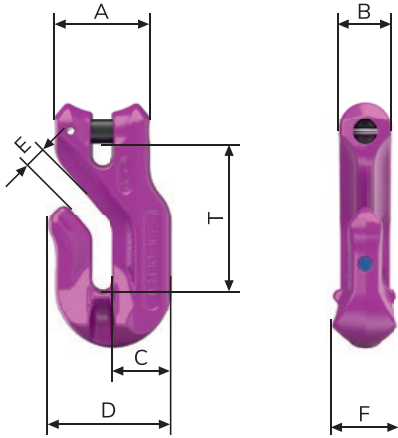

PRODUCT FEATURES

- No reduction of ICE-WLL.
- High dynamic strength.
- Angled insertion opening makes it difficult for the loose chain to slide out.
- Widened hook tip to prevent improper use, e.g. incorrect attachment of the chain.
- Corresponding with norm DIN 5692. Chains groove depth > 5 x nominal thickness of chain.
- Complete with connection bolts and clamp pin pre-assembled.

Chains	WLL [t]	Designation	A	B	C	D	E	F	T	Weight [kg/pc.]	Order no.
6	1.8	IVH-6	34	18	20	44	7.5	22	53	0.27	7900129
8	3.0	IVH-8	43	24	26	55	9.5	29	67	0.56	7900133
10	5.0	IVH-10	55	30	34	71	12	38	86	1.2	7900134
13	8.0	IVH-13	70	38	43	90	15	48	105	2.5	7900136
16	12.5	IVH-16	86	47	53	110	18.5	66	128	4.6	7900138

Subject to technical changes!

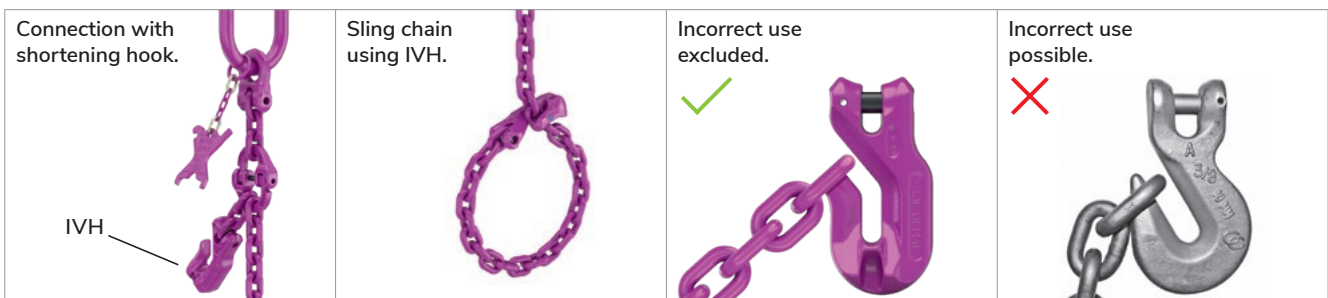

ICE-H Connector.

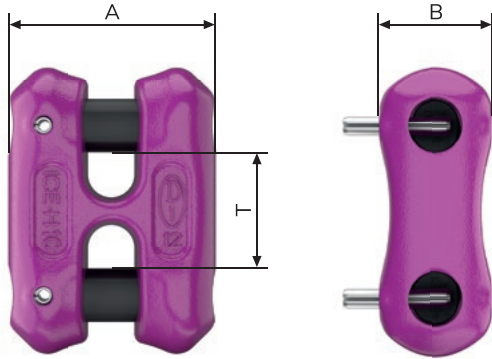

PRODUCT FEATURES

- Fast simple and economical way to make a chain endless.
- H-Connectors and chain have the same pitch.
- Suitable for repair of multiple-strand chains.
- More compact and easier to handle than conventional chain connectors.
- Tempered main body, making it more wear resistant.
- Ergonomically shaped.
- Improved sliding over the edges.
- Very flexible: Fits shape of chain and component.

20 % REDUCTION FOR ENDLESS CHAINS (SHARP EDGES) AND CHOKING IS TAKEN INTO ACCOUNT.

	IKR-H	Ø 4 mm	Ø 6 mm	Ø 8 mm	Ø 10 mm	Ø 13 mm	Ø 16 mm
	Endless chain with choke hitch	1.25	2.88	4.8	8.0	12.8	20.0
	0-45°	0.88	2.0	3.3	5.5	8.8	14.0
	45-60°	0.64	1.44	2.4	4.0	6.4	10.0

Subject to technical changes!

Chains	WLL [t]	Designation	A	B	T	Weight [kg/pc.]	Order no.
4	0.8	IH-4	24	12	12	0.04	7906659
6	1.8	IH-6	34	19.6	18	0.14	7901922
8	3.0	IH-8	45	25.5	24	0.26	7901453
10	5.0	IH-10	56	31.5	30	0.55	7901454
13	8.0	IH-13	73	40	39	1.16	7901455
16	12.5	IH-16	89	49	48	2.16	7901924

Subject to technical changes!

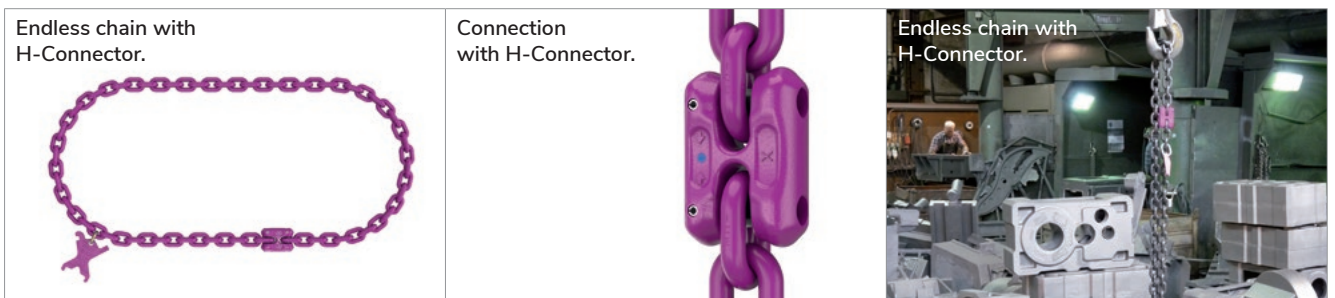

ICE-multi-shortening claw.

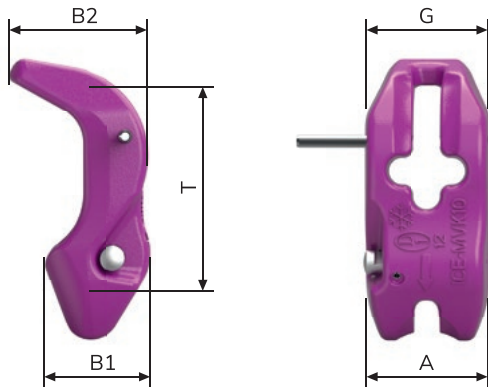

PRODUCT FEATURES

- Further development of the VMVK with adaptation to the ICE-Requirements.
- Captive installed in the continuous chain strand.
- Can be mounted at any position on the chain strand, or moved on the chain.
- No additional chain and coupling part required.
- Ideal support of the chain by the link-shaped bag support – meaning no reduction of WLL.
- The robust, spring-mounted safety bolt prevents the suspended chains from loosening automatically when unloaded or when load is attached.
- Complies with DIN 5692.

Chains	WLL [t]	Designation	A	B1	B2	G	T	Weight [kg/pc.]	Order no.
6	1.8	IMVK-6	38	32	41	37	66	0.28	7900985
8	3.0	IMVK-8	47	40	54	47	88	0.61	7900981
10	5.0	IMVK-10	60	51	67	60	110	1.6	7900983
13	8.0	IMVK-13	77	65	87	77	143	2.6	7900984
16	12.5	IMVK-16	95	81	110	95	176	4.8	7900986

Subject to technical changes!

<p>1. Pull the loose chain strand through the cross slot of the IMVK and drive safety pin A into place.</p>	<p>2. Without any strain on the chains, insert the required chain link of the strand to be loaded into seat pocket 1, press safety bolt 3 and pull in the chain strand downwards.</p>	<p>3. Release safety bolt 3 and check the lock.</p>	<p>4. Release in the reverse order (pressed safety bolt 3).</p>

Attention:
When using the IMVK without **safety pin A**, the chains must always be fully clipped into **locking slot B**. When pulling or lifting the shortened chains, the chains must always be fully clipped into **locking slot B**.

ICE-Balancer.

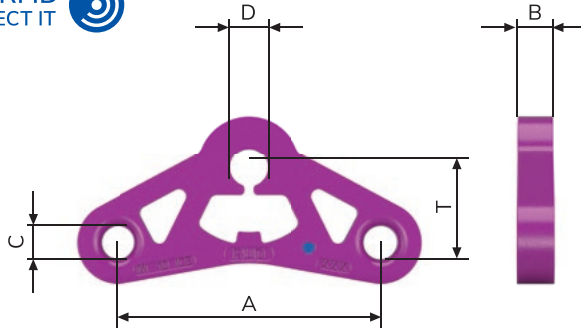

PRODUCT FEATURES

- Balancer connection at top: Connection by shackles.
- Balancer connection at bottom: ICE-Connection links.
- Easy recognition of the limit tilt angle of 10° due to special shaping on the bottom of the balancer.
- Powder coated in ICE-Pink.
- Detailed information on the ICE-Balancer can be found in the operating manual.

Chains	Designation	WLL balancer [t] 0-45°	A	B	C	D	T	Weight [kg]	Order no.
6	IW-6	2.5	110	15	14	21	46	0.49	7904367
8	IW-8	4.25	150	20	18	26	59	1.15	7904370
10	IW-10	7.1	180	25	23	32	76	2.4	7904372
13	IW-13	11.2	240	30	28	38	91	4.37	7904375
16	IW-16	17.0	300	35	32	41	120	8.8	7904255

Subject to technical changes!

COMPARISON OF ICE-4-STRAND SUSPENSION / ICE 2 x 2-STRAND BALANCER SUSPENSION.

Chains	WLL [t] ICE-4-Strand suspension 0-45°	WLL [t] ICE-2 x 2-Strand balancer suspension up to $\beta = 45^\circ$
6	3.75	5.1
8	6.3	8.4
10	10.6	14.1
13	17.0	22.4
16	26.5	35.0

Subject to technical changes!

DESIGN OF ICE-BALANCER HEAD IWK-2S.

Chains [mm]	Designation ICE-Balancer head (A)	Dimensions of IAK and IA link	Connection at top	Connection at bottom	Division of balancer head L1 [mm]	Weight of balancer head [kg/pc.]	Order no. ICE-Balancer head
6	IWK-2S-6	18 x 90 x 160	VV-SCH10 (4.0 t)	IVS 6	301	2.33	7904654
8	IWK-2S-8	26 x 100 x 180	VV-SCH13 (6.7 t)	IVS 8	363	5.39	7904655
10	IWK-2S-10	32 x 110 x 200	VV-SCH16 (10.0 t)	IVS 10	423	9.99	7904656
13	IWK-2S-13	36 x 140 x 260	VV-SCH5.0 (25.0 t)	IVS 13	555	17.5	7904657
16	IWK-2S-16	46 x 190 x 350	VV-SCH6.0 (31.5 t)	IVS 16	698	37.54	7904658

Subject to technical changes!

DESIGN OF ICE-MASTER LINK IAK-2S FOR BALANCER SUSPENSION.

Chains [mm]	Designation ICE-2-Strand master link for balancer suspension (B)	Dimensions of IAK and IA link	Division 2-strand IAK L2 [mm]	Weight 2-strand IAK [kg/pc.]	Order no. ICE-Balancer head
6	IAK 2S-6	18 x 90 x 160	265	1.8	7904659
8	IAK 2S-8	26 x 100 x 180	309	4.09	7904660
10	IAK 2S-10	32 x 110 x 200	369	7.37	7904661
13	IAK 2S-13	36 x 140 x 260	467	12.44	7904662
16	IAK 2S-16	46 x 190 x 350	603	24.87	7904663

Subject to technical changes!

Maximum inclination angle $\beta = 45^\circ$.

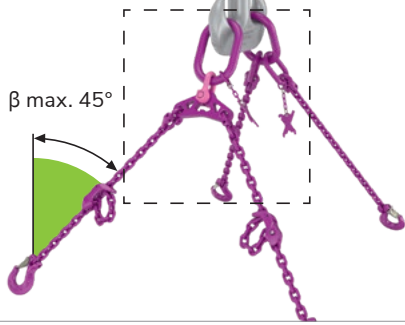

1

PLEASE NOTE THE FOLLOWING WHEN USING THE ICE-BALANCER SUSPENSION:

- The load must be symmetrical.
- The inclination angle β must not be greater than 45° (see diagrams 1 and 2).
- The inclination of the balancer must not be greater than 10° (see diagrams 3, 4 and 5).
- Detailed information on the ICE-Balancer can be found in the operating manual.
- Higher WLL at $\beta = 15^\circ$ or $\beta = 30^\circ$ see operating manual.

With a 4-strand suspension, a maximum of only 3 strands can be assumed to be load-bearing. In unfavourable cases only 2 strands are used.

Our TIP:

When using a 2 x 2-strand suspension in the configuration shown, an **even load distribution** to all 4 strands and a **33 % higher WLL** than a standard 4-strand suspension.

Higher WLL at $\beta = 15^\circ$ or $\beta = 30^\circ$ see operating manual.

Attention:

The 2-strand suspension with balancer may not be used by itself as a 2-strand suspension. Work equipment for lifting loads must prevent the unintentional dangerous movement of the load (compare BetrSichV, Annex 1 (3.2.3)).

Ask the manufacturer about asymmetric load cases. We are pleased to advise you!

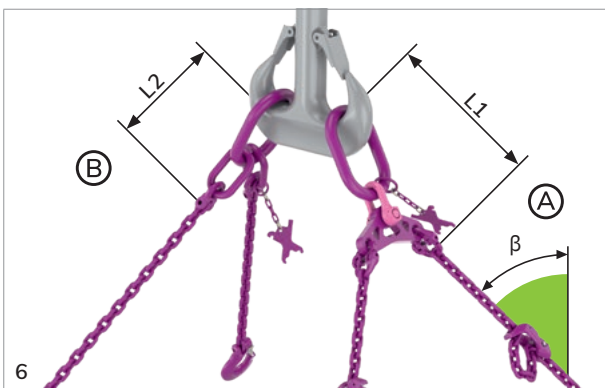
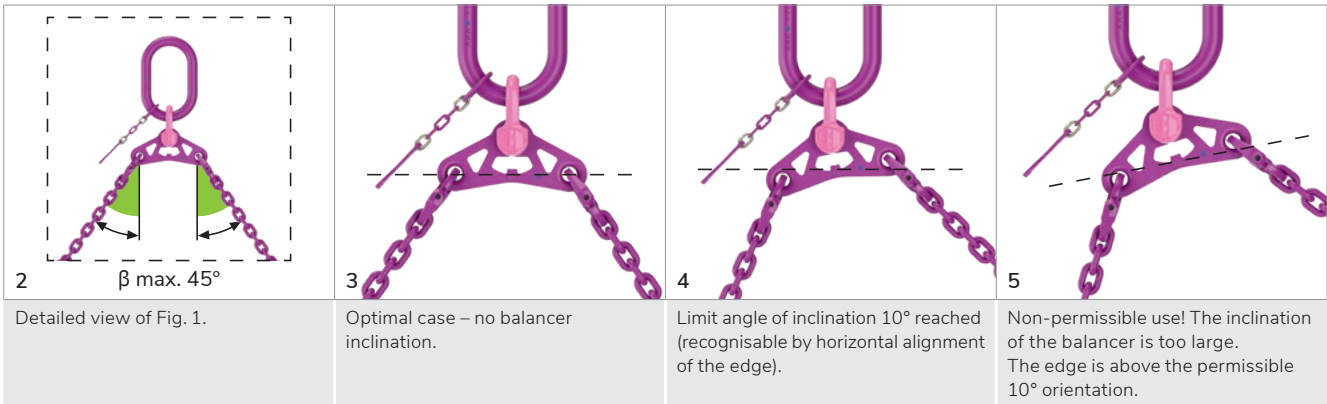

6

DESIGN OF ICE-BALANCER HEAD IWK-2S (A) CONSISTING OF:

- IA link with KZA.
- VIP-Shackles.
- ICE-Balancer.
- 2 ICE-Connecting links.

ICE-CURT-K



ICE-Bar spindle tensioner with locking handle for lifting – light and robust.

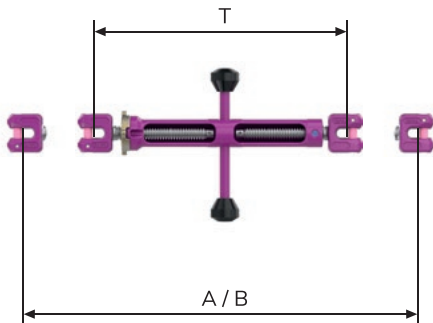

T = length closed
A = length open
B = lift

PRODUCT FEATURES

- With easy to handle, space-saving toggle.
- Practical loosening of lock, with preparation for padlock (e.g. type ABUS 85/40 HB), 100 % crack-tested, all load-bearing parts drop-forged.
- Easy to clean and lubricate, innovative forging form – light and robust, patent pending, Made in Germany, easy to handle – also with gloves.

Chains Ø	Designation	Lifting WLL [t]	L-open	L-closed	Lift	Weight [kg/pc.]	Order no.
6	ICE-CURT-K-6-GAKO	1.8	400	260	140	1.8	7904448
8	ICE-CURT-K-8-GAKO	3.0	520	350	170	3.2	7904449
10	ICE-CURT-K-10-GAKO	5.0	532	362	170	3.6	7904450
13	ICE-CURT-K-13-GAKO	8.0	830	530	300	6.9	7904451
16	ICE-CURT-K-16-GAKO	12.5	962	612	350	12.2	7904452

Subject to technical changes!



With ICE-CURT-K-...-GAKO for precise compensation of chain suspensions.

- With clevis connection for exact length compensation of chain suspensions.
- Length can be adjusted to the exact mm by means of right and left-hand threads via toggle.
- **Attention:** May only be adjusted without a load applied.

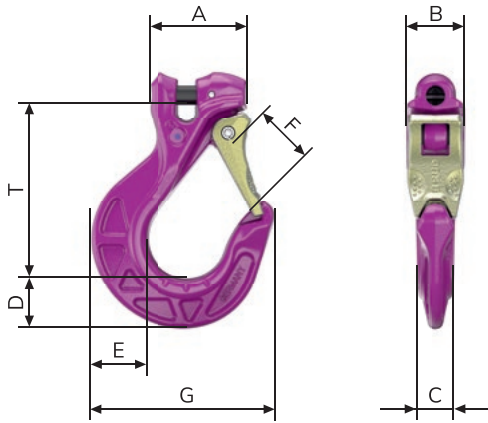

PRODUCT FEATURES

- Innovative structured design, finite elements up to 25 % lighter than hooks of grade 8 with the same WLL, i.e. the next largest nominal chain thickness.
- Large jaw opening as with the granite super hook, proven a million times over – the next largest nominal thickness – no skimping!
- Protective edges – on the sides and on top for folding protection.
- Wear occurrence ribs – to protect the first chain link.
- No protruding hook tip (no hooking).
- Thickened hook tip – prevents dangerous hook tip WLL.
- Drop-forged, tempered, ergonomically designed folding safety device and protected, stainless, triple-wound long-term double leg spring. Here the standard values for lateral load capacity are exceeded many times over.

Chains	WLL [t]	Designation	A	B	C	D	E	F	Fmax.	G	T	Weight [kg/pc.]	Order no.
4	0.8	ISH-4	22	15	13	14.5	16.5	20	–	53	55	0.16	7904693
6	1.8	ISH-6	48	28	18	27	30	30	51	97	97	0.69	7998179
8	3.0	ISH-8	58	36	20	29	35	36	57	112	110	1.1	7995254
10	5.0	ISH-10	71	43	26	37	42	41	66	135	127	1.9	7995255
13	8.0	ISH-13	85	52	31	50	56	50	80	166	153	3.6	7995256
16	12.5	ISH-16	94	58	41	61	74	58	96	202	184	6.0	7995257

Subject to technical changes!



Patented wear occurrence marks.

- Folding safety devices of the RUD hook families GSH, SH, COBRA and the ICE-STAR hook can be mounted one below the other (note the difference in nominal thickness) – easy spare parts procurement.
- Fmax. = Distance of marking points for quick detection of unacceptable deformation.

ICE-Foundry hook.

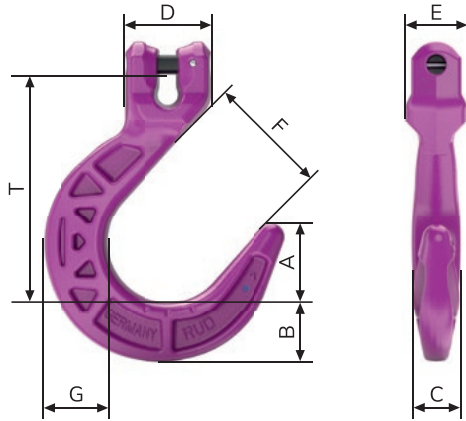

PRODUCT FEATURES

- Also referred to as foundry or container hook.
- Weight optimised by Skeletto design.
- With non-mix-up clevis connection.
- Robust cross-section (dimension C and G) against higher bending forces.
- Protection and wear occurrence edges (dimension E).
- Patented wear occurrence marks in the hook base.
- Only use where unintentional removal is not possible (risk assessment)!

Designation	WLL [t]	A	B	C	D	E	F	Fmax.	G	T	Weight [kg/pc.]	Order no.
IWH-6	1.8	41	31	24	42	29	64	91	32	121	1.0	7904360
IWH-8	3.0	49	37	29	50	36	76	108	40	143	1.76	7904361
IWH-10	5.0	58	44	31	64	46	90	127	47	169	3.0	7903847
IWH-13	8.0	66	50	39	75	56	102	145	55	193	4.7	7904362
IWH-16	12.5	75	56	43	90	58	114	177	61	208	6.9	7904363

Subject to technical changes!



- Fmax. = Distance of marking points for quick detection of unacceptable deformation.

IMEG

ICE-Dumper truck suspension-ring.

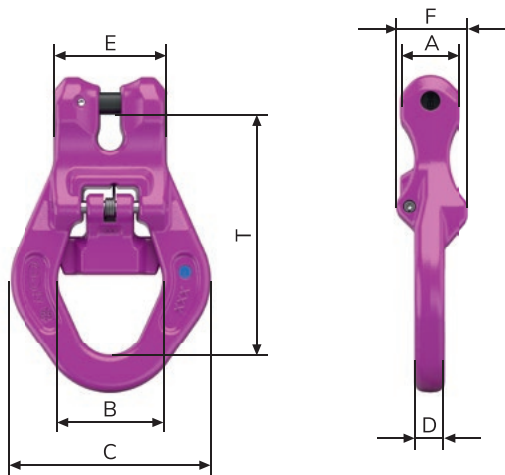

PRODUCT FEATURES

- Fast, robust and user-friendly.
- Quick attachment, without separate unlatching.
- Simplified mounting and dismounting of the recess link through ergonomically designed locking latch.
- Locking latch with anti-slip shaping.
- Protective ribs protect the locking latch from damage and impact.
- To suit shaped recess pins according to DIN/EN 30720.

Chains	WLL [t]	Designation	A	B	C	D	E	F	T	Weight [kg/pc.]	Order no.
10	5.0	IMEG-10	37	66	128	20	64	46	153	1.6	7901607
13	8.0	IMEG-13	38	66	128	19	73	46	147	2.2	8504471

Subject to technical changes!



IAGH

ICE-Clevis self locking hook.

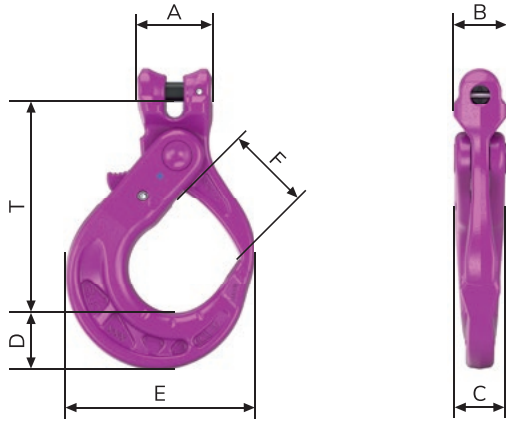

PRODUCT FEATURES

- Innovative lightweight construction, thus up to 30 % lighter than automatic hooks of grade 8 with the same WLL, i.e. the next largest nominal chain thickness.
- Large jaw opening as with grade 80 hooks of the next larger nominal chain size – no skimping!
- Ergonomically designed locking lever, user-friendly and with non-slip surface – no danger of crushing.
- Wear occurrence ribs – to protect the first chain link.
- Thickened hook tip – prevents dangerous hook tip WLL.
- Marking points to check the size of the jaw width!
- Patented wear occurrence marks which indicate the legally required discard criteria without measuring.

Chains Ø	WLL [t]	Designation	A	B	C	D	E	F	Fmax.	T	Weight [kg/pc.]	Order no.
6	1.8	IAGH-6	34	24	27	28	97	44	60	113	0.9	7900085
8	3.0	IAGH-8	45	31	30	31	106	48	66	124	1.27	7997691
10	5.0	IAGH-10 ¹	50	38	36	40	133	61	81	154	2.45	7997692
13	8.0	IAGH-13 ¹	73	50	44	51	173	78	107	200	4.9	7997693
16	12.5	IAGH-16	90	61	49	53	192	85	121	232	7.4	7900086

¹ For use on recesses, see page 57 IMAGH-10 and -13.

Subject to technical changes!

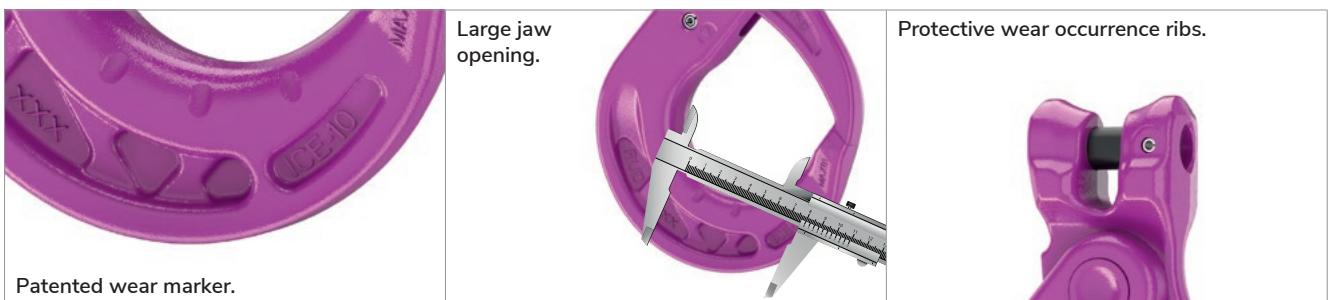

Spare parts only available as a complete set: Consisting of drop-forged locking lever, stainless long-term double jaw spring, safety pin and assembly sleeve. Simple assembly/removal with a hammer and driver.

Only use original RUD ICE-Spare parts!

IMAGH



ICE-Clevis self locking hook for dumper trucks.

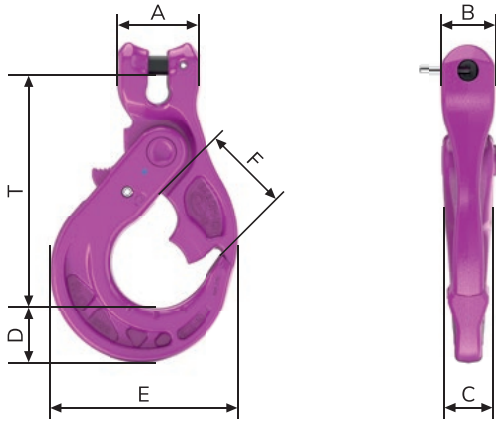

PRODUCT FEATURES

- Innovative lightweight construction, thus up to 30 % lighter than automatic hooks of grade 8 with the same WLL, i.e. the next largest nominal chain size.
- Large jaw opening as with grade 80 hooks of the next larger nominal thickness – no skimping!
- Ergonomically designed locking lever, user-friendly and with non-slip surface – no danger of crushing.
- Wear occurrence ribs – to protect the first chain link.
- Thickened hook tip – prevents dangerous hook tip WLL.
- Patented wear occurrence marks which indicate the legally required discard criteria without measuring.

Chains	WLL [t]	Designation	A	B	C	D	E	F	Fmax.	T	Weight [kg/pc.]	Order no.
10	5.0	IMAGH-10	61	37	36	40	137	50	81	171	2.9	7902113
13	8.0	IMAGH-13	70	37	40	40	140	50	81	167	3.6	7906216

Subject to technical changes!



▪ Fmax. = Distance of marking points for quick detection of unacceptable deformation.

IRG

ICE-Clevis connector.



PRODUCT FEATURES

- As individual part for external connections to clevis connections, flanges, etc.
- Complete with ICE-Connecting bolts and clamping sleeve pre-assembled.

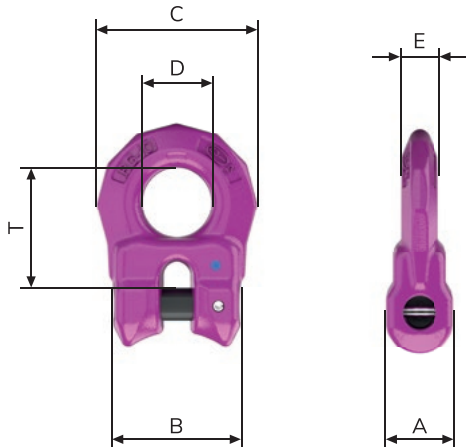

Chains	WLL [t]	Designation	A	B	C	D	E	T	Weight [kg/pc.]	Order no.
6	1.8	IRG-6	19	34	44	21	10	36	0.12	7902998
8	3.0	IRG-8	24	45	56	26	12.5	43	0.25	7902999
10	5.0	IRG-10	30	56	70	31	16	53	0.53	7903000
13	8.0	IRG-13	38	73	88	37	19	67	1.0	7903001
16	12.5	IRG-16	47	90	109	46	24	83	2.1	7903002

Subject to technical changes!



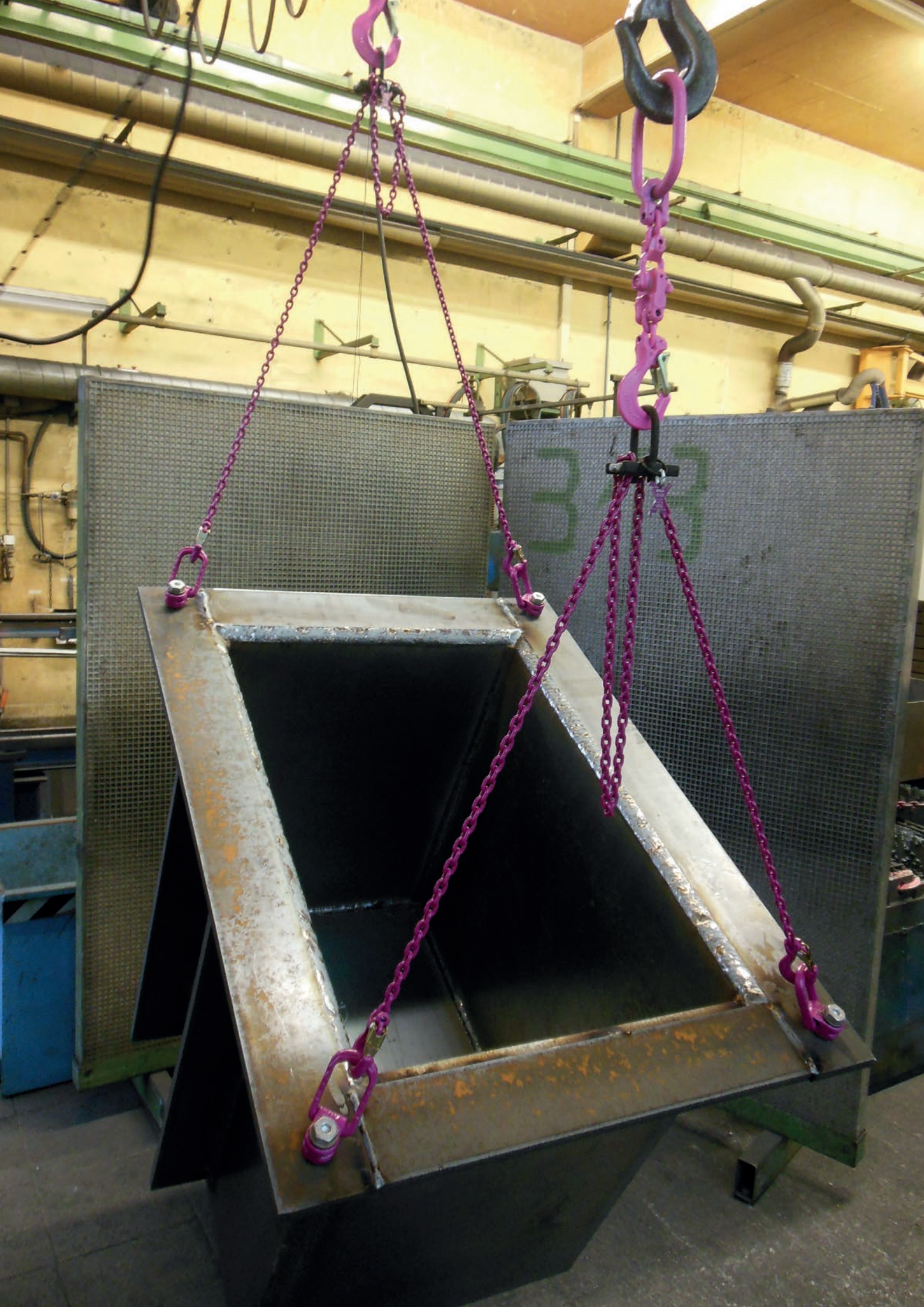

ICE-MINI CONSTRUCTION KIT

The ideal program for small loads.

The MINI-Lifter, which was specially developed for this range, also offers special advantages for simple lifting or slinging tasks. Since the master link and shortening element are combined, the chain strand can be brought to the required length quickly and easily. And thanks to the low dead weight of the sling chain, even higher loads can in many cases be lifted with a slewing crane.

COMPONENTS.

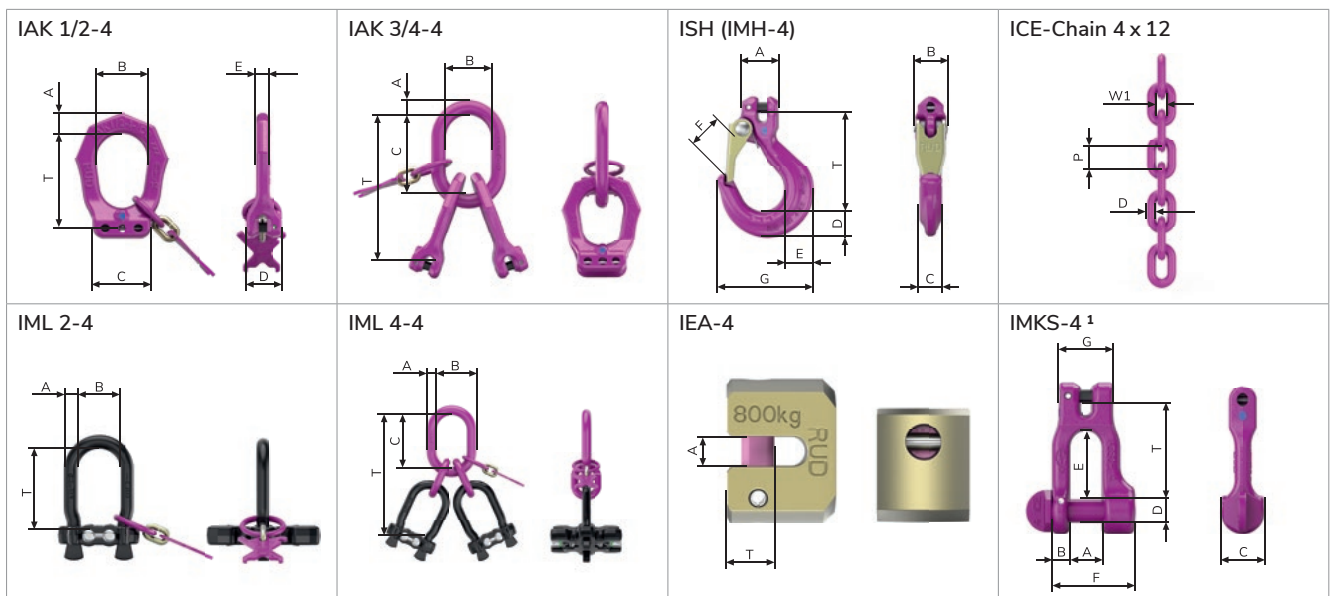

¹ under preparation.

COMPONENTS – TECHNICAL DATA.

WLL [t]	Designation	Ø	A	B	C	D	E	F	T	Weight [kg/pc.]	Order no.
0.8	IAK 1/2	4	13	34	38	22.5	8	-	58	0.2	7905031
1.7 / 1.18	IAK 3/4	4	10	35	60	-	-	-	120	0.5	7905033
0.8	ISH-4 (IMH)	4	22	15	13	14.5	16.5	20	55	0.16	7904693
0.8	ICE-Chain	4	-	5.2 (W1)	-	4	-	-	12 (P)	0.44	7904694
1.12 / 0.8	IML-2	4	10	30	-	-	-	-	66	0.35	7905075
1.7 / 1.18	IML-4	4	11	35	60	-	-	-	156	0.85	7905076
-	IEA-4	4	4.8	-	-	-	-	-	8	0.04	7905039
-	IMKS-4 ¹	4	¹ under preparation.								



Subject to technical changes!

The smallest 4 mm round steel chains in grade 12.

WLL of up to 1,180 kilograms are fully sufficient for many lifting operations. The ICE-MINI construction kit is made for applications like these. The nominal thickness of only 4 millimetres makes the ICE-MINI chain extremely slim and light, which significantly improves ergonomics for the user. It is therefore an excellent solution for all lifting tasks that have to be carried out several times a day.

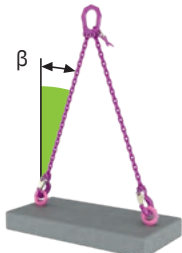
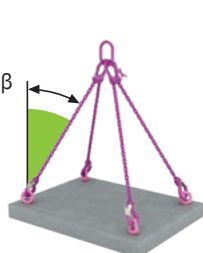
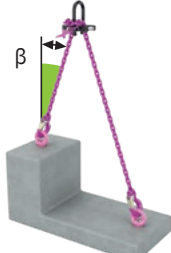
SUSPENSION – FIXED / VARIO (ADJUSTABLE).

			
1-strand fixed WLL max. 800 kg	2-leg fixed WLL max. 1,120 kg	3-/4-strand fixed WLL max. 1,700 kg	2-strand vario ² ICE-MINI standard suspension with MINI-lifter (usable length 1 m)

	<p>Larger crane hook?</p> <p>Simply use in addition to the MINI-Lifter the appropriate ICE-Master link IAK-RG-1.</p> <p>The ideal helper for small loads up to 1.7 t, in goods receipt and in toolmaking!</p>		
4-strand vario ²		2-strand with MINI-Lifter and IAK-RG-1-10 to suit crane hook no. 6 (DIN 15401)	4-strand with MINI-Lifter and IAK-RG-1-10 to suit crane hook no. 6 (DIN 15401)

Inclination angle- β	1-strand	2-strand		3-/4-strand	
	0°	0-45°	> 45-60°	0-45°	> 45-60°
Factor	1	1.4	1	2.1	1.5
WLL in (kg) ICE-MINI 4 mm	800	1,120	800	1,700	1,180

² According to DGUV rule 100-500 chapter 2.8, the single strand WLL applies in the event of asymmetrical loading of a multiple strand suspension.

Subject to technical changes!

RUD ICE-SPARE PARTS

ICE-SPARE LATCH FOR ISH

Subject to technical changes!

- Consisting of forged safety latch, triple coiled stainless steel double leg spring and safety pin.
- Only available as a complete set.
- Simple assembly/removal with a hammer and drift punch.

Chains	Designation	[kg/pc.]	Order no.
4	Si-Set ICE-SH-4	0.02	7987901
6	Si-Set ICE-SH-6	0.09	7100300
8	Si-Set ICE-SH-8	0.11	7100301
10	Si-Set ICE-SH-10	0.15	7100302
13	Si-Set ICE-SH-13	0.24	7100303
16	Si-Set ICE-SH-16	0.4	7900419



ICE-SECURING ELEMENTS FOR RECESS SUSPENSION LINK IMEG

Subject to technical changes!

- Consisting of:
 - 1 locking lever
 - 1 spring
 - 2 clamping sleeves

Chains	Designation	Order no.
10 / 13	Spare part set for IMEG-10 / IMEG-13 and VMEG-13	7902648
10 / 13	Spare bolt set IMEG10 / VMEG13 (contains 20 units)	7910986



ICE-SAFETY ELEMENTS AUTOMATIC HOOK

Subject to technical changes!

- Consisting of:
 - 1 locking lever
 - 1 spring
 - 2 clamping sleeves

Chains	Designation	Order no.
6	Spare part set for IAGH 6	8503759
8	Spare part set for IAGH 8	8503713
10	Spare part set for IAGH 10 and IMAGH 10 + 13	7998255
13	Spare part set for IAGH 13	8503714
16	Spare part set for IAGH 16	8503760
6	Assembly set without locking lever for IAGH 6	7910416
8	Assembly set without locking lever for IAGH 8	7910417
10	Assembly set without locking lever for IAGH 10 / IMAGH 10+13	7910418
13	Assembly set without locking lever for IAGH 13	7910419
16	Assembly set without locking lever for IAGH 16	7910420



ENDLESS CHAINS IDENTIFICATION TAG

Subject to technical changes!

- Grade-neutral identification tag for endless chains.

Designation	Order no.
Endless chains identification tag	7909698



ICE-PDA TEST DATA TAG

Subject to technical changes!

- Test data tag for permanent marking of the test intervals according to DGUV rule 100-500 (BGR 500).

Designation	Order no.
Test data tag PDA	60228



Only use original RUD ICE-Spare parts!

ICE-SAFETY ELEMENTS IVS

Subject to technical changes!

- Spare part set for VIP- and ICE-Connecting link consisting of:
 - 1 bolt
 - 2 clamping sleeves

Chains	Designation	Order no.
6	RUD spare part set for IVS-6 and VVS-6	7903886
8	RUD spare part set for IVS-8 and VVS-8	7903887
10	RUD spare part set for IVS-10 and VVS-10	7903888
13	RUD spare part set for IVS-13 and VVS-13	7903889
16	RUD spare part set for IVS-16 and VVS-16	7903890



ICE-SPARE PART SET FOR IMVK AND IML

Subject to technical changes!

- Spare part set for IMVK consisting of:
 - 1 safety bolt
 - 1 pressure spring
 - 1 clamping sleeve (for assembly of the safety bolt)
 - 1 clamping sleeve, long (for chains lock in the slot)

Chains	Designation	[kg/pc.]	Order no.
4	Si set for IML-4	0.05	7987159
6	Si set for IMVK-6	0.03	7995046
8	Si set for IMVK-8	0.04	7987081
10	Si set for IMVK-10	0.06	7987082
13	Si set for IMVK-13	0.14	7991182
16	Si set for IMVK-16	0.2	7991183



ICE-SPARE BOLTS WITH SAFETY PIN

Subject to technical changes!

- Only available as a pack of 10.
- Non-mix-up with RUD assembly bolts of other grades.
- Only available as a packing unit.

Chains	Designation	Order no.
4	IOG-4 / safety pin 4	7905626
6	IOG-6 / safety pin 6	7998740
8	IOG-8 / safety pin 8	7995739
10	IOG-10 / safety pin 10	7995740
13	IOG-13 / safety pin 13	7995741
16	IOG-16 / safety pin 16	7999102 ¹



¹ Only available as a packing unit with 4 units.

THE RUD VIP-CONSTRUCTION KIT.





THE RUD VIP-CONSTRUCTION KIT.





OVERVIEW
VIP-CONSTRUCTION KIT PART 1.

			4:1		-XX° XXX° C	XXX° C max.		DGUV TEST	DNVGL TEST
			Safety factor 4:1	100% electromagnetically crack-tested	Application temperature range without WLL reduction	Max. application temperature with WLL reduction	RUD BLUE-ID SYSTEM	DGUV approval	Certified according to the DNVGL guideline
CHAINS									
p. 74		VIP-Lifting means 0.63t-31.5t	<input checked="" type="checkbox"/>	<input checked="" type="checkbox"/>	<input checked="" type="checkbox"/>	<input checked="" type="checkbox"/>		<input checked="" type="checkbox"/>	<input checked="" type="checkbox"/>
p. 75		VIP-VKZA (VIP-Identification tag)							
MASTER LINKS									
p. 76		VBK-1 1.5t-31.5t	<input checked="" type="checkbox"/>	<input checked="" type="checkbox"/>	<input checked="" type="checkbox"/>	<input checked="" type="checkbox"/>	<input checked="" type="checkbox"/>	<input checked="" type="checkbox"/>	<input checked="" type="checkbox"/>
p. 77		VBK-2 2.1t-45.0t	<input checked="" type="checkbox"/>	<input checked="" type="checkbox"/>	<input checked="" type="checkbox"/>	<input checked="" type="checkbox"/>	<input checked="" type="checkbox"/>	<input checked="" type="checkbox"/>	<input checked="" type="checkbox"/>
p. 78		VAK-1 / -2 / -4 1.5t-31.5t / 2.1t-45.0t / 3.1t-42.0t	<input checked="" type="checkbox"/>	<input checked="" type="checkbox"/>	<input checked="" type="checkbox"/>	<input checked="" type="checkbox"/>	<input checked="" type="checkbox"/>	<input checked="" type="checkbox"/>	<input checked="" type="checkbox"/>
p. 80		VSAK-1 / -2 / -4 1.5t-10.0t, 2.5t-10.0t, 4.0t-20.0t / 2.1t-14.0t, 3.5t-14.0t, 5.6t-28.0t / 3.1t-8.4t, 3.1t-14.0t, 8.4t-42.0t	<input checked="" type="checkbox"/>	<input checked="" type="checkbox"/>	<input checked="" type="checkbox"/>	<input checked="" type="checkbox"/>	<input checked="" type="checkbox"/>		
CONNECTING AND SHORTENING ELEMENTS									
p. 82		UW-PP + VWA 0.63t-10.0t / 16.0t-20.0t	<input checked="" type="checkbox"/>	<input checked="" type="checkbox"/>	<input checked="" type="checkbox"/>	<input checked="" type="checkbox"/>	<input checked="" type="checkbox"/>	<input checked="" type="checkbox"/>	
p. 83		PP-X-B 0.63t-10.0t	<input checked="" type="checkbox"/>	<input checked="" type="checkbox"/>	<input checked="" type="checkbox"/>	<input checked="" type="checkbox"/>		<input checked="" type="checkbox"/>	
p. 84		VVH 1.5t-20.0t	<input checked="" type="checkbox"/>	<input checked="" type="checkbox"/>	<input checked="" type="checkbox"/>	<input checked="" type="checkbox"/>	<input checked="" type="checkbox"/>	<input checked="" type="checkbox"/>	
p. 85		VMVK 1.5t-10.0t	<input checked="" type="checkbox"/>	<input checked="" type="checkbox"/>	<input checked="" type="checkbox"/>	<input checked="" type="checkbox"/>	<input checked="" type="checkbox"/>	<input checked="" type="checkbox"/>	<input checked="" type="checkbox"/>
p. 86		VV 16.0t-31.5t	<input checked="" type="checkbox"/>	<input checked="" type="checkbox"/>	<input checked="" type="checkbox"/>	<input checked="" type="checkbox"/>	<input checked="" type="checkbox"/>	<input checked="" type="checkbox"/>	<input checked="" type="checkbox"/>
p. 87		VGIL 1.5t-10.0t	<input checked="" type="checkbox"/>	<input checked="" type="checkbox"/>	<input checked="" type="checkbox"/>	<input checked="" type="checkbox"/>	<input checked="" type="checkbox"/>		

THE RUD VIP-CONSTRUCTION KIT.

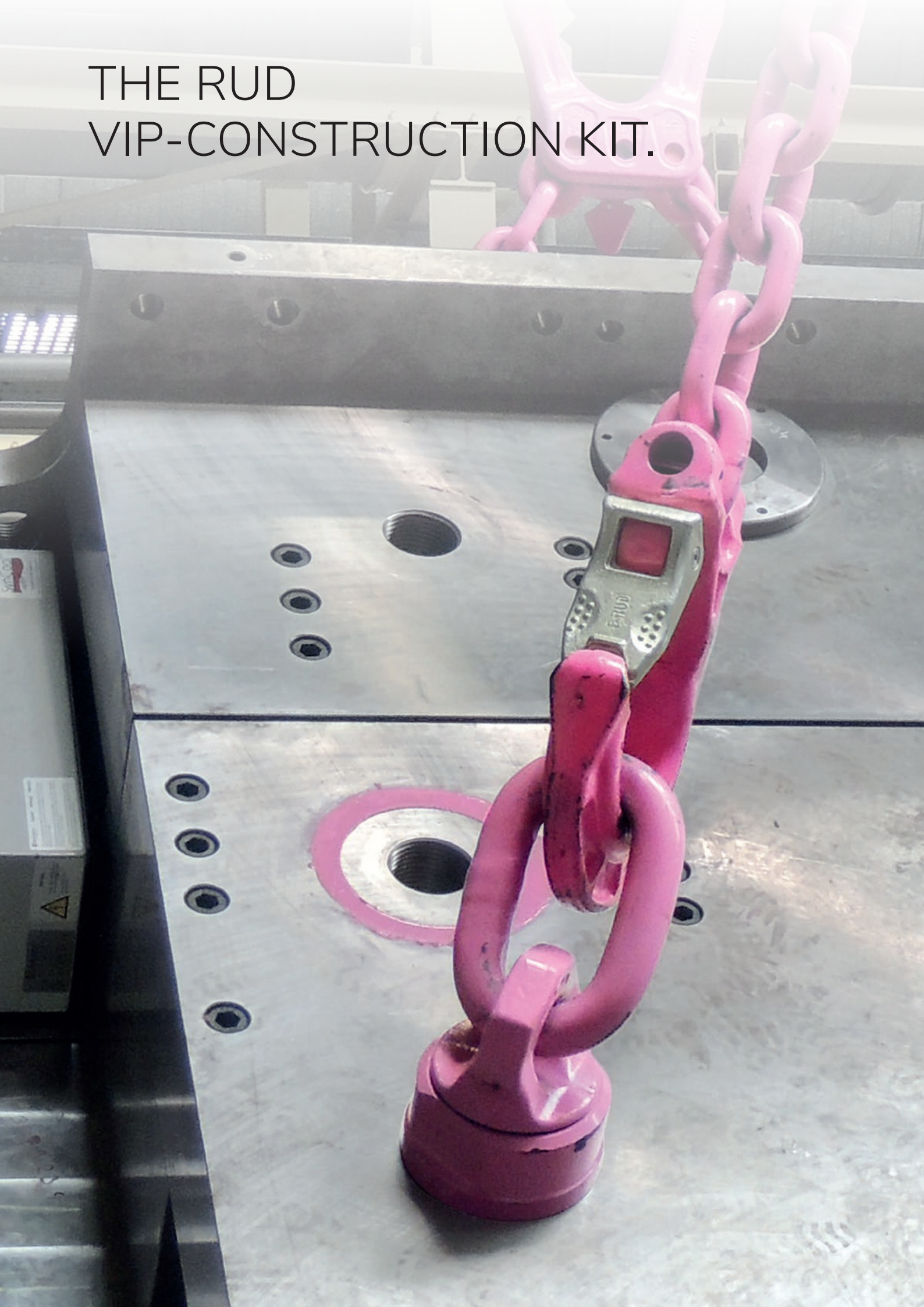



OVERVIEW
VIP-CONSTRUCTION KIT PART 2.

	4:1		>XX° XXX° C	XXX° C max.	BLUE-ID	DGUV TEST	DNVGL TEST
	Safety factor 4:1	100% electromagnetically crack-tested	Application temperature range without WLL reduction	Max. application temperature with WLL reduction	RUD BLUE-ID SYSTEM	DGUV approval	Certified according to the DNVGL guideline
CONNECTING AND SHORTENING ELEMENTS							
p. 88 VV-SCH 1.5t-10.0t	■	■	■	■	■	■	■
p. 88 VC-SCH 16.0t-31.5t	■	■	■	■	■	■	
p. 89 VV-GSCH 1.5t-20.0t	■	■	■	■	■	■	■
p. 89 OCTOPUS 5.25t	■	■	■	■	■	■	
p. 90 VVS 1.5t-31.5t	■	■	■	■	■	■	
p. 91 VIP-Dominator 16.0t-31.5t	■	■					
p. 92 VW 3.15t-56.0t	■	■	■	■	■	■	
p. 94 VCB 20.0t-63.0t, 18.5t-58.0t, 14.0t-45.0t	■	■	■	■	■		
p. 95 VCG 1.5t-20.0t		■	■	■			
p. 96 VSRS 2.1t-28.0t, 1.5t-20.0t	■	■	■		■		
p. 97 VSRV 2.1t-28.0t, 1.5t-20.0t	■	■	■		■		

THE RUD VIP-CONSTRUCTION KIT.





OVERVIEW
VIP-CONSTRUCTION KIT PART 3.

			4:1		>XX° XXX° C	XXX° C max.	BLUE-ID 	DGUV TEST	DNVGL TEST
			Safety factor 4:1	100% electromagnetically crack-tested	Application temperature range without WLL reduction	Max. application temperature with WLL reduction	RUD BLUE-ID SYSTEM	DGUV approval	Certified according to the DNVGL guideline
END COMPONENTS									
p. 98		VCGH 1.5t–31.5t	■	■	■	■	■	■	■
p. 99		VCÖH 0.63t–10.0t	■	■	■	■	■	■	
p. 100		VWH 1.5t–20.0t	■	■	■	■	■	■	
p. 101		VAGH-S 2.5t–6.7t	■	■	■	■	■	■	
p. 102		VBMHWA 2.5t–4.0t	■	■	■	■	■		
p. 103		HWA 0.4t–5.0t, 0.25t–2.0t							
p. 104		VCH 12.5t	■	■	■	■	■		
p. 105		VCH-K 10.0t	■	■	■	■	■		
p. 106		VCH-SL 22.0t	■	■	■	■	■		
p. 107		VERG 1.5t–10.0t	■	■	■	■	■		
VIP-MAXI CONSTRUCTION KIT, p. 108–113									
VIP-MINI CONSTRUCTION KIT, p. 114–115									
SPARE PARTS VIP, p. 116–117									

OPTIMAL COMBINATIONS.

VIP-Master links: non-mix-up with VIP-Welded connectors.

	VAK / VBK	VAK / VBK	VAK / VBK	VSAK (1- / 2- / 4-strand)
1-strand		2-strand	4-strand	Suspensions not shortened.
			Suspension shortened with VIP-Shortening hooks VVH.	
				Suspension shortened with VIP-Multi-shortening claw VMVK.

















END COMPONENTS									
VB	VA	VCGH	VWH	VAGH (S)	UW-PP	VMVK	VVH	VV-GSCH	VCH-K

VIP-DESIGN OR DESIGNATION EXAMPLE – COMPLETE SUSPENSION.

	Grade	Number of strands	Master link	Shortening / strands	Shortening / component	End component	Chains	Required usable length (mm) – not shortened
	10 VIP	G1	VAK	1	VMVK	VCGH	10 Ø	2,000
VIP-G1 (VAK)-VMVK-VCGH / 10 x 2,000								

OPTIMAL COMBINATIONS.

VIP-Combination options | Endless chain.

	VAK / VBK 	VAK / VBK 	VAK / VBK 	VSAK (1- / 2- / 4-strand)  140 190 250	
Single	 CE	Double	 CE	Suspensions not shortened.  CE	
	 CE		 CE	Endless	Endless chain shortened with VIP-Shortening hooks IVH.  CE
	 CE		 CE		Endless chain shortened with VIP-Multi-shortening claw IMVK.  CE
	 CE		 CE	 CE	

Always the right lifting solution.

With VIP-Products, RUD offers you the largest chains in the world. This allows an individually suitable lifting solution to be configured for every lifting requirement.

Handling:

RUD VIP-Chains and components (grade 10) may not be combined with chains and components of other manufacturers or other grades. Attention: Incorrect handling and use of these lifting chains can lead to material and/or personal damage!

Important safety information must be observed:

DIN-EN 818, DIN-EN 1677, DGUV rule 100-500 (BGR 500) Chap. 2.8, EU Machinery Directive 2006/42/EC, manufacturer usage information, BGI 556 / DGUV information 209-013.

We assume no liability for damage caused by disregarding these standards and safety information.

VIP-DESIGN OR DESIGNATION EXAMPLE – COMPLETE SUSPENSION.

	Grade	Endless chain	Single (E) / double (D)	Number of shortenings	Shortening / component	Chains	Required usable length (mm) – not shortened
	10 VIP	KR	E	1	VMVK	10 Ø	2,000
VIP-KRE (VMVK)-10 x 2,000							

VIP-LIFTING MEANS



VIP-Lifting means in grade 10.

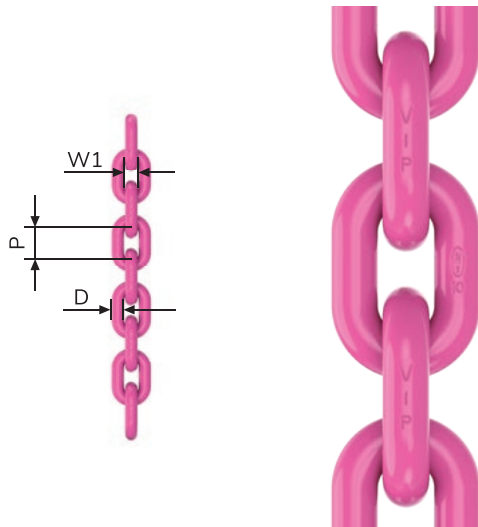

PRODUCT FEATURES

- Grade 100 or VIP-Lifting chains from RUD are made from CrNiMo stainless steel. Due to an in-house special tempering process, the grade 100 chains retain a high degree of toughness despite their high strength. A clear optical feature is the fluorescent powder coating in pink. A quality feature of VIP-Lifting chains is that they are certified in accordance with the DGVV (BG) principles, which are based, for example, on EN 818 and PAS 1061, and therefore bear the H1 stamp.
- This is applied in short chain link intervals and, in addition to adherence to the principles, means that RUD was the first manufacturer with grade 100 certification. Further customer-specific approvals are of course available on request. VIP-Quality in pink stands for highly dynamic lifting chains from RUD, which are less sensitive to external mechanical abrasion and damage, which means a longer service life.

D = nominal thickness [mm Ø]	4	6	8	10	13	16	20	22	28
P = division [mm]	12	18	24	30	39	48	60	66	84
W1 = inner width [bi min. mm]	5.2	7.8	10.4	13	17	21	26	28.6	36.4
WLL [t]	0.63	1.5	2.5	4.0	6.7	10	16	20	31.5
Test force MPF min. kN	15.7	37.5	62.5	100	166	250	395	500	772
Test force BF min. kN	25	60	100	160	265	400	630	800	1240
Weight [kg/pc.]	0.38	0.91	1.56	2.44	4.0	6.0	9.8	12.3	18.6
Order no. VIP-Pink	7984399	7100477	7100478	7100479	7100480	7100481	7983689	7100482	7900670
Order no. Corrud-DS black	7987349	7988020	7988021	7988754	-	7903259	-	-	-

Subject to technical changes!

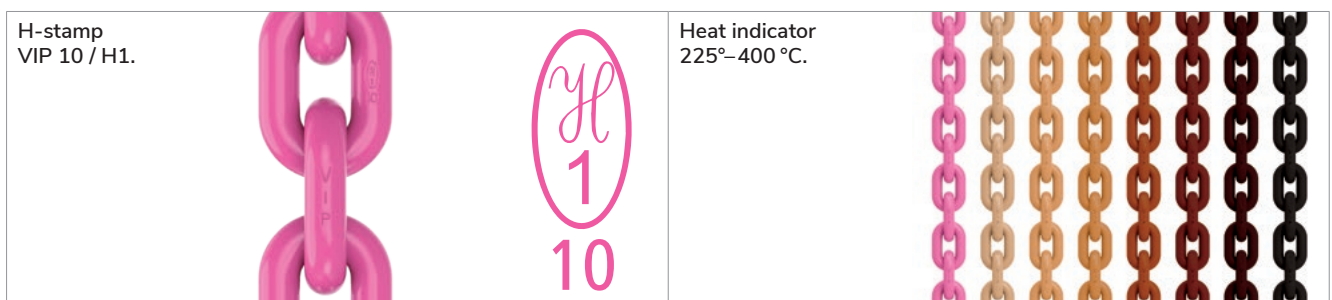

More information on page 26.

- Elongation at break:
A min.: natural black $\geq 25\%$, pink $\geq 20\%$
- Stamping: VIP-Marking on the back of each chain link, production number and BG approval stamp $< m$.

VIP-KZA

VIP-Identification tag.



VIP-IDENTIFICATION TAG FOR VIP-CHAIN.

	Chains	Designation	Order no.
	13, 16, 20, 22, 28	VIP-KZA	7989739

Subject to technical changes!

VIP-IDENTIFICATION TAG WITH INTEGRATED CHAIN GAUGE.

	Chains	Designation	Order no.
	4	VKZA-4	7987054
	6	VKZA-6	7100804
	8	VKZA-8	7100805
	10	VKZA-10	7100806
	13	VKZA-13	7100807

Subject to technical changes!

VIP-IDENTIFICATION TAG AS A CHAIN GAUGE, SEPARATE FOR Ø 13 mm / 16 mm / 20 mm / 22 mm.

	Chains	Designation	Order no.
	13	VKPL-13	7100667
	16	VKPL-16	7100672
	20	VKPL-20	7104045
	22	VKPL-22	7101832
	28	MAXI-Tester 28	7900709

Subject to technical changes!

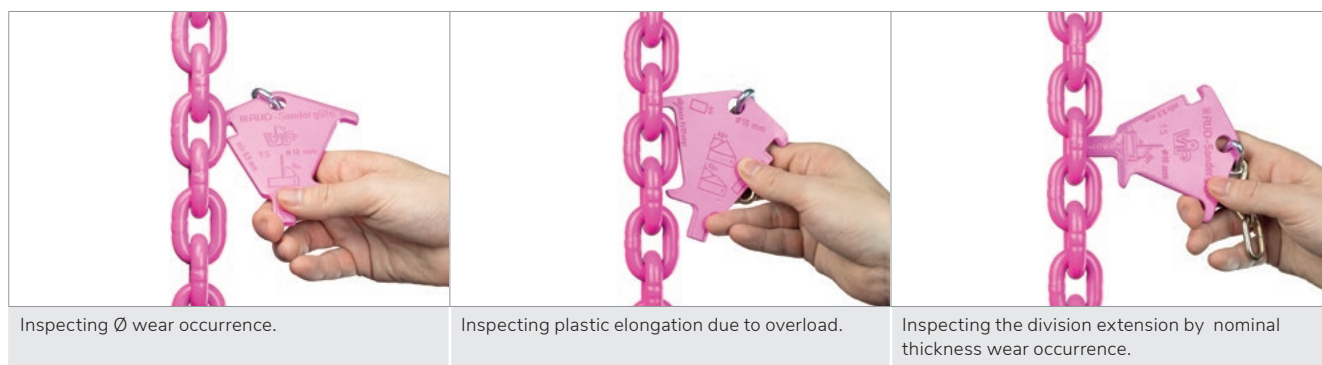

Inspecting Ø wear occurrence.

Inspecting plastic elongation due to overload.

Inspecting the division extension by nominal thickness wear occurrence.

More information on pages 120–121.

VBK-1



VIP-Master link 1-strand for smaller load hook.

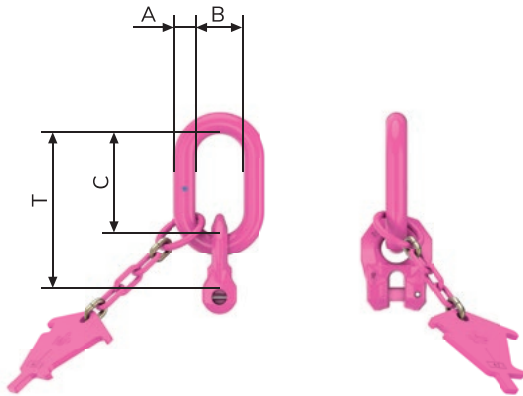

PRODUCT FEATURES

- All master links on this page are equipped with welded-in connectors that can be moved on all sides.
- This results in a non-mix-up connection to chain diameter and number of strands.
- The master link is supplemented with an identification tag (KZA) with integrated chain test gauge.
- Dimensions according to intermediate link shape B according to DIN 5688.
- Adequate for hanging on small load hooks like chain hoist.

VBK-1-STRAND MASTER LINK.

Chains	WLL (t)	Designation	A	B	C	T	Weight [kg/pc.]	Order no.
6	1.5	VBK-1-6 (VB-1-6)	13	25	54	82	0.4	7100675 (7100220)
8	2.5	VBK-1-8 (VB-1-8)	16	34	70	107	0.7	7100676 (7100221)
10	4.0	VBK-1-10 (VB-1-10)	18	40	85	131	1.1	7100677 (7100222)
13 ¹	6.7	VBK-1-13 (VB-1-13)	22	50	115	174	2.2	7100678 (7100223)
16 ¹	10.0	VBK-1-16 (VB-1-16)	26	65	140	211	3.8	7100679 (7100224)
20 ¹	16.0	VBK-1-20 (VB-1-20)	32	75	170	264	7.6	7104092 (7104093)
22 ¹	20.0	VBK-1-22 (VB-1-22)	36	110	200	294	9.0	7100680 (7102060)
28 ²	31.5	VBK-1-28 (VB-1-28)	60	190	265	322	31.9	8504022 ²
28 ²	31.5	(VB-1-28)	62	130	150	215	13.7	(7900641) ²

¹ Attention: Master links size 13/16/20/22 with special identification tag. A test tag is additionally enclosed for master links 13/16/20/22.

Subject to technical changes!

² See VIP-MAXI construction kit on pages 108–113.

- VIP-Connection bolts and safety bolt are pre-assembled.
- Also available as end link (VB 1-) (without VIP-Identification tag).

VBK-2



VIP-Master link 2-strand for smaller load hook.

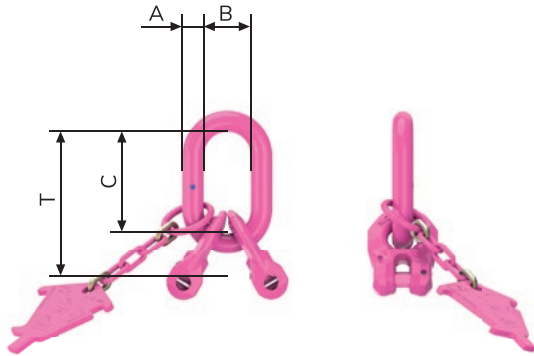

PRODUCT FEATURES

- All master links on this page are equipped with welded-in connectors that can be moved on all sides.
- This results in a non-mix-up connection to chain diameter and number of strands.
- The master link is supplemented with an identification tag (KZA) with integrated chain test gauge.
- Dimensions according to intermediate link shape B according to DIN 5688.
- Adequate for hanging on small load hooks on lifting gear.

VBK-2-STRAND MASTER LINK.

Chains	WLL (t)	Designation	A	B	C	T	Weight [kg/pc.]	Order no.
6	2.1 / 1.5	VBK-2-6	13	25	54	82	0.5	7100700
8	3.5 / 2.5	VBK-2-8	16	34	70	107	0.9	7100701
10	5.6 / 4.0	VBK-2-10	18	40	85	131	1.5	7100702
13 ¹	9.5 / 6.7	VBK-2-13	22	50	115	174	3.0	7100703
16 ¹	14.0 / 10.0	VBK-2-16	26	65	140	211	5.4	7100704
20 ¹	22.4 / 16.0	VBK-2-20	32	75	170	264	11.0	7104097
22 ¹	28.0 / 20.0	VBK-2-22	36	110	200	294	12.8	7100705
28 ²	45.0 / 31.5	VBK-2-28	60	190	265	322	35.0	8504022 ²

¹ Attention: Master links size 13/16/20/22 with special identification tag.
A test tag is additionally enclosed for master links 13/16/20/22.

² See VIP-MAXI construction kit on pages 108–113.

Subject to technical changes!

- VIP-Connection bolts and safety latch are pre-assembled.

VAK-1 / -2 / -4



VIP-Standard master link with welded-in connectors.



PRODUCT FEATURES

- All master links on this page are equipped with welded-in connectors that can be moved on all sides.
- This results in a non-mix-up connection to chain diameter and number of strands.
- The master link is supplemented with an identification tag (KZA) with integrated chain test gauge.
- Dimensions in accordance with suspension link shape A according to DIN 5688.

VAK-1.

VAK-1 master link with welded-in connectors – VRG – that can be moved on all sides, thus forced connection for \emptyset chain and number of strands. Complete identification tag with integrated chain gauge. Connection bolts and safety pin are pre-assembled. Dimensions in accordance with suspension link shape A according to DIN 5688. Also available as end link (VA-1..) (without identification tag).

Chains	WLL (t)	Designation	A	B	C	T	Weight [kg/pc.]	Order no.
6	1.5	VAK-1-6 (VA-1-6)	13	60	110	138	0.6	7100681 (7100237)
8	2.5	VAK-1-8 (VA-1-8)	16	60	110	147	0.9	7100682 (7100238)
10	4.0	VAK-1-10 (VA-1-10)	18	75	135	181	1.4	7100683 (7100239)
13 ¹	6.7	VAK-1-13 (VA-1-13)	22	90	160	218	2.7	7100684 (7100240)
16 ¹	10.0	VAK-1-16 (VA-1-16)	26	100	180	250	4.3	7100685 (7100241)
20 ¹	16.0	VAK-1-20 (VA-1-20)	40	180	340	434	14.7	7104089 (7104090)
22 ¹	20.0	VAK-1-22 (VA-1-22)	45	180	340	434	18.0	7100686 (7102092)
28 ²	31.5	VAK-1-28 (-)	100	250	280	360	64.3	7900642 ² (-)

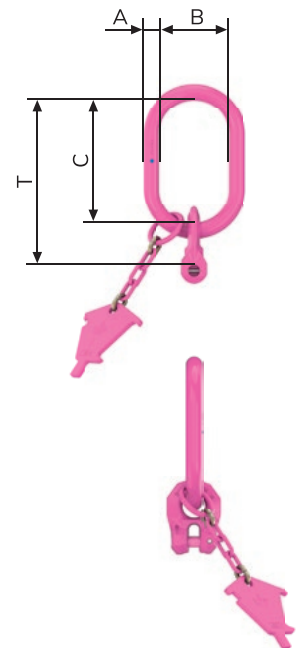

¹ Attention: Master links size 13/16/20/22 with special identification tag.

A test tag is additionally enclosed for master links 13/16/20/22.

² See VIP-MAXI construction kit on pages 108–113.

Subject to technical changes!

- VIP-Connection bolts and clamp pin are pre-assembled.
- Also available as end link (VA 1-) (without VIP-Identification tag).

VAK-2.

VAK-2-master link with 2 welded-in connectors – VRG – that can be moved on all sides, thus forced connection for Ø chain and number of strands. Complete identification tag with integrated chain gauge. Connection bolts and safety pin are pre-assembled. Dimensions in accordance with suspension link shape A according to DIN 5688.

Chains	WLL (t)	Designation	A	B	C	T	Weight [kg/pc.]	Order no.
6	2.1/1.5	VAK-2-6	13	60	110	138	0.7	7100706
8	3.5/2.5	VAK-2-8	16	75	135	172	1.4	7100707
10	5.6/4.0	VAK-2-10	18	90	160	206	2.4	7100708
13 ¹	9.5/6.7	VAK-2-13	22	100	180	238	4.3	7100709
16 ¹	14.0/10.0	VAK-2-16	26	110	200	270	7.6	7100710
20 ¹	22.4/16.0	VAK-2-20	40	180	340	434	18.0	7104095
22 ¹	28.0/20.0	VAK-2-22	45	180	340	434	22.0	7100711
28 ²	45.0/31.5	VAK-2-28	100	250	280	360	69.5	7900642 ²

¹ Attention: Master links size 13/16/20/22 with special identification tag. A test tag is additionally enclosed for master links 13/16/20/22.

Subject to technical changes!

² See VIP-MAXI construction kit on pages 108–113.

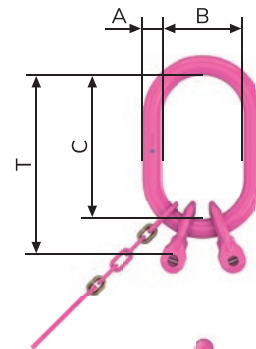

VAK-4.

VAK-4-strand master link with 4 welded-in connectors – VRG – that can be moved on all sides, thus forced connection for Ø chain and number of strands. Complete identification tag with integrated chain gauge. Connection bolts and safety pin are pre-assembled. Dimensions in accordance with master link shape A, intermediate link shape B according to DIN 5688.

Chains	WLL (t)	Designation	A	B	C	T	Weight [kg/pc.]	Order no.
6	3.1/2.2	VAK-4-6	18	75	135	217	1.8	7100742
8	5.2/3.7	VAK-4-8	22	90	160	268	3.4	7100743
10	8.4/6.0	VAK-4-10	26	100	180	311	5.5	7100744
13 ¹	14.0/10.0	VAK-4-13	32	110	200	373	10.4	7100745
16 ¹	21.5/15.0	VAK-4-16	36	140	260	470	17.6	7100745
20 ¹	33.6/24.0	VAK-4-20	51	190	350	614	39.1	7104181
22 ¹	42.0/30.0	VAK-4-22	51	190	350	644	45.7	7100747

¹ Attention: Master links size 13/16/20/22 with special identification tag. A test tag is additionally enclosed for master links 13/16/20/22.

Subject to technical changes!

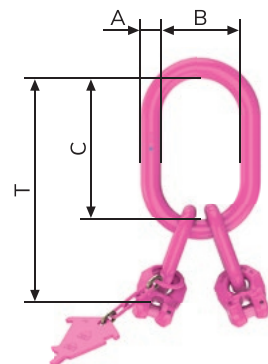

3-strand master links VAK 3 and VSAK 3 same order no. as 4-strand master links. No separate stocking for this item.

SELECTION TABLE FOR CRANE HOOK SIZES ³.

Size	6	8	10	13	16	20	22	28
VAK-1	No. 2.5	No. 5	No. 6	No. 8	No. 10	No. 25	No. 25	No. 80
VAK-2	No. 2.5	No. 5	No. 6	No. 8	No. 10	No. 25	No. 25	No. 80
VAK-4	No. 5	No. 6	No. 8	No. 10	No. 16	No. 32	No. 32	–

³ For single crane hooks DIN 15401.

Subject to technical changes!

VSAK-1 / -2 / -4



VIP-Special master links with welded-in connectors.



PRODUCT FEATURES

- All special master links on this page are equipped with welded-in connectors that can be moved on all sides.
- This results in a non-mix-up connection to chain diameter and number of strands.
- The master link is supplemented with an identification tag (KZA) with integrated chain test gauge.
- Due to the greater diameter of the inner width "B" of the VSAK reduces an unauthorised use (DGUV rule 100-500 (BGR 500)) and wear occurrence on the crane hook. This saves a costly intermediate suspension for oversized crane hooks.

VSAK-1.

VSAK-1 master link with welded-in connectors – VRG – that can be moved on all sides, thus forced connection for Ø chain and number of strands. Complete identification tag with integrated chain gauge. Connection bolts and safety pin are pre-assembled.

Chains	WLL (t)	Designation	A	B	C	T	Weight [kg/pc.]	Order no.
6	1.5	VSAK-1-6 / 140	18	140	260	342	1.9	7100687
8	2.5	VSAK-1-8 / 140	22	140	260	367	3.2	7100688
10	4.0	VSAK-1-10 / 140	26	140	260	391	4.4	7100689
13 ¹	6.7	VSAK-1-13 / 140	32	140	260	433	7.4	7100690
16 ¹	10.0	VSAK-1-16 / 140	32	140	260	471	8.9	7100691
8	2.5	VSAK-1-8 / 190	22	190	350	457	3.7	7100692
10	4.0	VSAK-1-10 / 190	26	190	350	481	5.3	7100693
13 ¹	6.7	VSAK-1-13 / 190	32	190	350	523	8.7	7100694
16 ¹	10.0	VSAK-1-16 / 190	36	190	350	560	12.1	7100695
10	4.0	VSAK-1-10 / 250	36	250	460	591	11.7	7100696
13 ¹	6.7	VSAK-1-13 / 250	36	250	460	634	12.8	7100697
16 ¹	10.0	VSAK-1-16 / 250	40	250	460	671	17.0	7100698
20 ¹	16.0	VSAK-1-20 / 250	45	250	460	724	28.0	7104100
22 ¹	20.0	VSAK-1-22 / 250	51	250	460	754	34.0	7100699

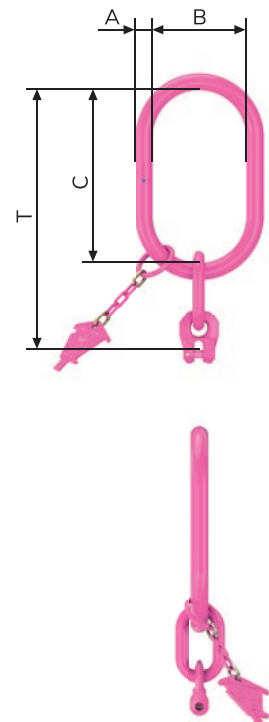

¹ Attention: Master links size 13/16/20/22 with special identification tag. A test tag is additionally enclosed for master links 13/16/20/22.

Subject to technical changes!

VSAK-2.

VSAK-2 master link with 2 welded-in connectors – VRG – that can be moved on all sides, thus forced connection for Ø chain and number of strands. Complete identification tag with integrated chain gauge. Connection bolts and safety pin are pre-assembled.

Chains	WLL (t)	Designation	A	B	C	T	Weight [kg/pc.]	Order no.
6	2.1 / 1.5	VSAK-2-6 / 140	18	140	260	342	2.3	7994070
8	3.5 / 2.5	VSAK-2-8 / 140	22	140	260	367	3.5	7994071
10	5.6 / 4.0	VSAK-2-10 / 140	26	140	260	391	5.2	7994072
13 ¹	9.5 / 6.7	VSAK-2-13 / 140	32	140	260	433	9.2	7994073
16 ¹	14.0 / 10.0	VSAK-2-16 / 140	32	140	260	471	12.5	7994074
8	3.5 / 2.5	VSAK-2-8 / 190	22	190	350	457	4.3	7994075
10	5.6 / 4.0	VSAK-2-10 / 190	26	190	350	481	6.5	7994076
13 ¹	9.5 / 6.7	VSAK-2-13 / 190	32	190	350	523	10.6	7994077
16 ¹	14.0 / 10.0	VSAK-2-16 / 190	36	190	350	560	15.6	7994078
10	5.6 / 4.0	VSAK-2-10 / 250	36	250	460	591	12.8	7994079
13 ¹	9.6 / 6.7	VSAK-2-13 / 250	36	250	460	634	14.8	7994080
16 ¹	14.0 / 10.0	VSAK-2-16 / 250	40	250	460	671	20.5	7994081
20 ¹	22.4 / 16.0	VSAK-2-20 / 250	45	250	460	724	32.5	7994083
22 ¹	28.0 / 20.0	VSAK-2-22 / 250	51	250	460	754	40.0	7994084

¹ Attention: Master links size 13/16/20/22 with special identification tag. A test tag is additionally enclosed for master links 13/16/20/22.

Subject to technical changes!

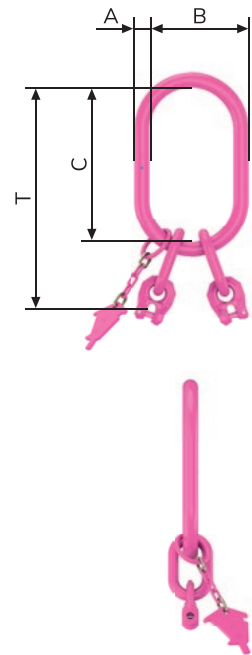

VSAK-4.

VSAK-4 master link with four welded-in connectors – VRG – that can be moved on all sides, thus forced connection for Ø chain and number of strands. Complete identification tag with integrated chain gauge. Connection bolts and safety pin are pre-assembled.

Chains	WLL (t)	Designation	A	B	C	T	Weight [kg/pc.]	Order no.
6	3.1 / 2.2	VSAK-4-6 / 140	22	140	260	342	3.3	7100748
8	5.2 / 3.7	VSAK-4-8 / 140	26	140	260	367	4.9	7100749
10	8.4 / 6.0	VSAK-4-10 / 140	32	140	260	391	7.9	7100750
6	3.1 / 2.2	VSAK-4-8 / 190	22	190	350	432	3.8	7100751
8	5.2 / 3.7	VSAK-4-10 / 190	26	190	350	457	5.9	7100752
10	8.4 / 6.0	VSAK-4-13 / 190	32	190	350	481	9.3	7100753
13 ¹	14.0 / 10.0	VSAK-4-16 / 190	36	190	350	523	14.0	7100754
10	8.4 / 6.0	VSAK-4-10 / 250	36	250	460	591	13.5	7100755
13 ¹	14.0 / 10.0	VSAK-4-13 / 250	40	250	460	634	19.0	7100756
16 ¹	21.5 / 15.0	VSAK-4-16 / 250	51	250	460	671	32.5	7100757
20 ¹	33.6 / 24.0	VSAK-4-20 / 250	54	250	460	754	48.0	7993210 ²
22 ¹	42.0 / 30.0	VSAK-4-22 / 250	56	250	460	763	56.0	7993211 ²

¹ Attention: Master links size 13/16/20/22 with special identification tag. A test tag is additionally enclosed for master links 13/16/20/22.

Subject to technical changes!

² With VVS connection.

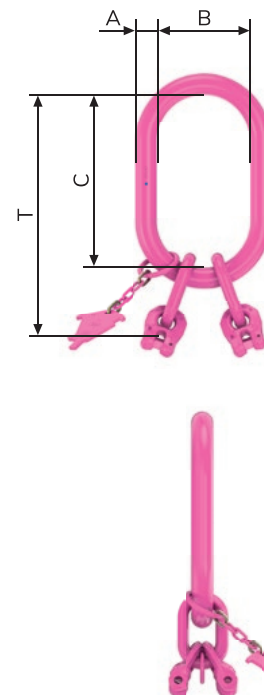

VSAK – dimension B = 140 for use up to single hook no. 16 DIN 15401
VSAK – dimension B = 190 for use up to single hook no. 32 DIN 15401
VSAK – dimension B = 250 for use up to single hook no. 50 DIN 15401

UW-PP + VWA



VIP-Universal swivel PowerPoint + VIP-Swivel connector.

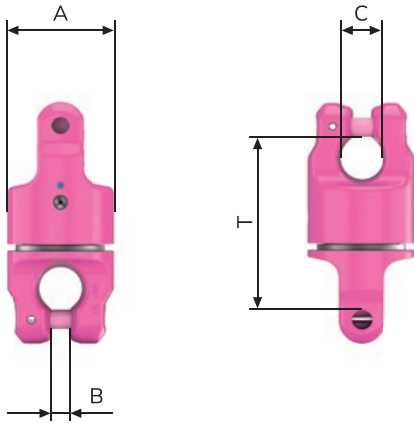

PRODUCT FEATURES

- The following applies to both versions: The DGVU rule prescribes: Lifting means must not be twisted before lifting – this is done automatically by UW-PP. Ball-bearing mounted – rotatable under load!
- Not suitable for permanent operation under full load.
- Special: VIP-Universal swivel PowerPoint! Patented clevis connection design! Thus universal connection – loadable on all sides – shortest possible combinations. Only mount RUD approved VIP-Chains and components.
 1. VIP-COBRA eye hooks VCÖH.
 2. B-link for PowerPoint PP-(WLL)-B.

Note: The VIP-Chain connection is non-mix-up. Pay attention to the correct WLL assignment for assembly 1 + 2!

VIP-UNIVERSAL SWIVEL POWERPOINT.

Chains	WLL (t)	Designation	A	B	C	D	T	Smax.	Weight [kg/pc.]	Order no.
4	0.63	UW-PP-4	32	4.8	13	-	56	4.5	0.2	7990878
6	1.5	UW-PP-6	38	7	16	-	68	4.5	0.42	7990879
8	2.5	UW-PP-8	52	9.1	20	-	88	6	1.0	7990880
10	4.0	UW-PP-10	66	11	26	-	106	6	1.9	7990881
13	6.7	UW-PP-13	80	14.4	30	-	131	6.5	3.6	7990882
16	10.0	UW-PP-16	86	17.6	37	-	141	8	4.9	7992861

Subject to technical changes!

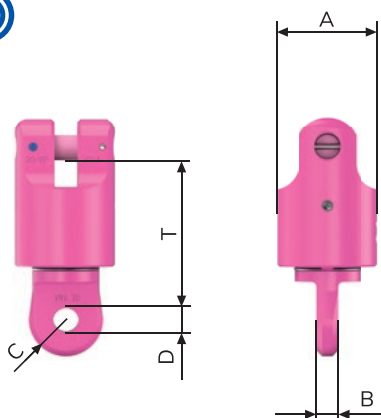

PRODUCT FEATURES

- Special: VWA
Can be mounted non-mix-up thanks to the adapter bar with all VIP-Clevis connection parts. Non-susceptible to dirt thanks to seal. NO WLL on bending. Install the VWA so that no bending can occur on the adapter during use.

VIP-SWIVEL ADAPTER.

Chains	WLL (t)	Designation	A	B	C	D	T	Smax.	Weight [kg/pc.]	Order no.
20	16.0	VWA-20	100	21	37	25	147	-	6.7	7990723
22	20.0	VWA-22	102	23	38	28	147	-	6.8	7100634

Subject to technical changes!

PP-X-B



VIP-Special master link –
lightweight construction.

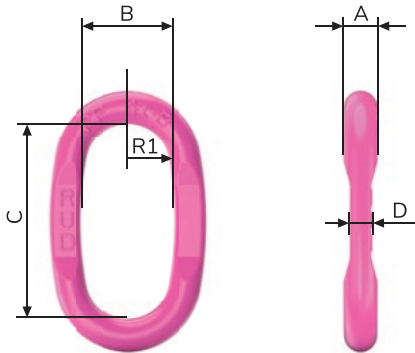

PRODUCT FEATURES

- Drop-forged special link (Pink) for small load hooks, extremely lightweight design – central flattening according to the corresponding VIP-Chain diameter.
- To suit the universal swivel PowerPoint or for PowerPoint-B lifting points.
- Care must be taken during assembly to ensure correct WLL allocation afterwards.

Chains	WLL (t)	Designation	A	B	C	D	R1	Weight [kg/pc.]	Order no.
4	0.63	PP 0.63t-B	9	35	65	4	15	0.1	7989531
6	1.5	PP 1.5t-B	11	35	65	6	15	0.14	8502173
8	2.5	PP 2.5t-B	13	40	75	8	18	0.2	8502174
10	4.0	PP 4t-B	16	45	95	10	20	0.32	8502175
13	6.7	PP 6.7t-B	21	60	130	13	25	1.02	8502176
16	10.0	PP 10t-B	24	65	140	16	28	1.4	8502177

Subject to technical changes!

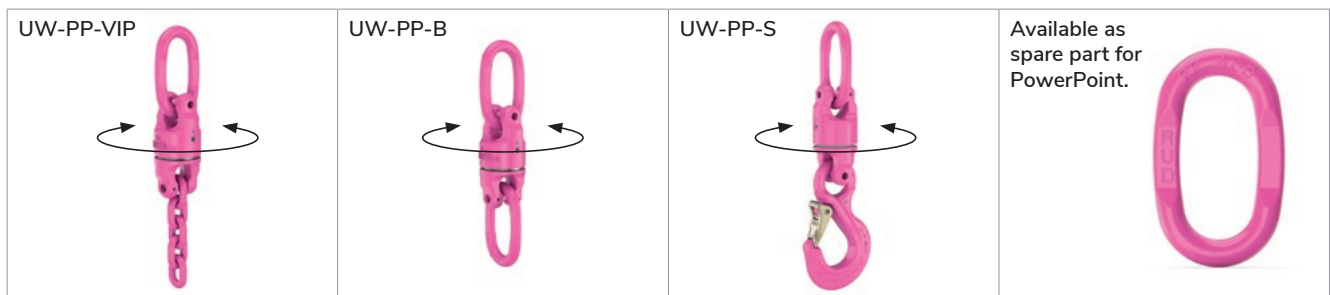

VIP-Shortening hook.

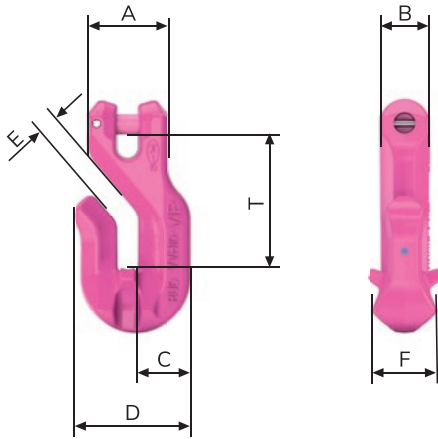

PRODUCT FEATURES

- No reduction of VIP-WLL.
- Angled insertion opening makes it difficult for the loose chain to slide out.
- Widened hook tip to prevent improper use, e.g. incorrect attachment of the chain.
- Corresponding with norm DIN 5692. Chains groove depth > 5 x chains nominal thickness.
- Complete with connection bolts and clamp pin pre-assembled.

Chains	WLL (t)	Designation	A	B	C	D	E	F	T	Weight [kg/pc.]	Order no.
6	1.5	VVH-6	34	18	20	44	7.5	23	53	0.27	7988658
8	2.5	VVH-8	38	22	25	54	9.5	33	64	0.4	7987319
10	4.0	VVH-10	47	28	31	68	12	42	80	1.0	7987320
13	6.7	VVH-13	60	36	40	87	15	47	103	2.2	7987321
16	10.0	VVH-16	75	45	50	108	18.5	57	125	4.0	7988669
20	16.0	VVH-20	92	58	63	138	24	76	162	8.4	8503630
22	20.0	VVH-22	102	62	69	151	26	83	179	11.0	8503631

Subject to technical changes!

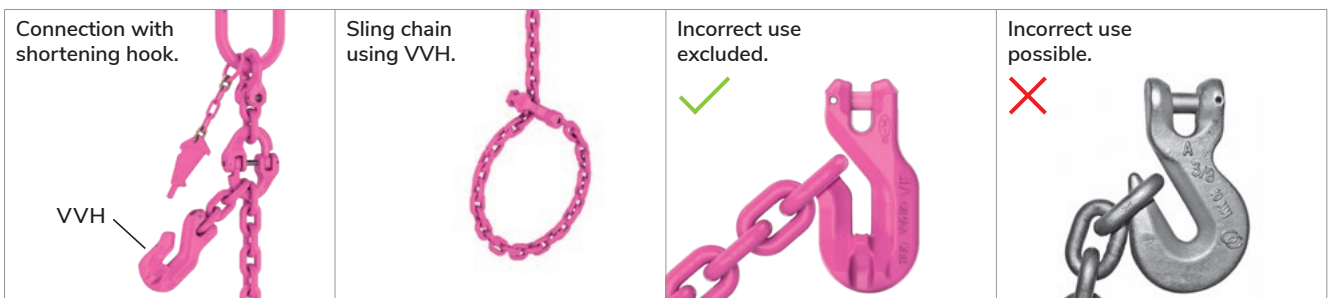

Attention!
Norm DIN 5692. RUD shortening hooks correspond with all requirements!

VIP-Multi-shortening claw.

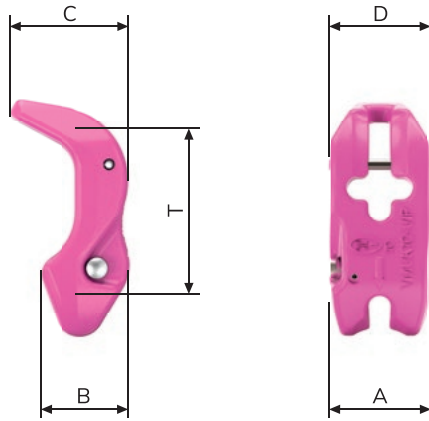

PRODUCT FEATURES

- Further development of the RUD shortening claw, which has been tried and tested for decades.
- Captive installed in the continuous chain strand.
- Can be mounted at any position on the chain strand, or moved on the chain.
- No additional chain and coupling part required.
- Ideal support of the chain by the link-shaped bag support – meaning no reduction of WLL.
- The robust, spring-mounted safety bolt prevents the suspended chains from loosening automatically when unloaded or under WLL.
- Complies with DIN 5692.

Chains	WLL (t)	Designation	A	B	C	D	T	Weight [kg/pc.]	Order no.
6	1.5	VMVK-6	34	30	40	35	66	0.25	7984072
8	2.5	VMVK-8	48	40	54	48	88	0.8	7100760
10	4.0	VMVK-10	60	49	67	60	110	1.2	7100761
13	6.7	VMVK-13	74	64	86	76	143	2.4	7100762
16	10.0	VMVK-16	91	79	105	98	176	4.4	7100763

Subject to technical changes!

<p>1. Pull the loose chain strand through the cross slot of the VMVK and drive safety pin A into place.</p>	<p>2. Without any strain on the chains, insert the required chain link of the strand to be loaded into seat pocket 1, press safety bolt 3 and pull in the chain strand downwards.</p>	<p>3. Release safety bolt 3 and check the lock.</p>	<p>4. Release in the reverse order (pressed safety bolt 3).</p>

Attention!
 Norm for shortening elements DIN 5692.
 All RUD shortening components correspond with all requirements!

VIP-Shortening claw.

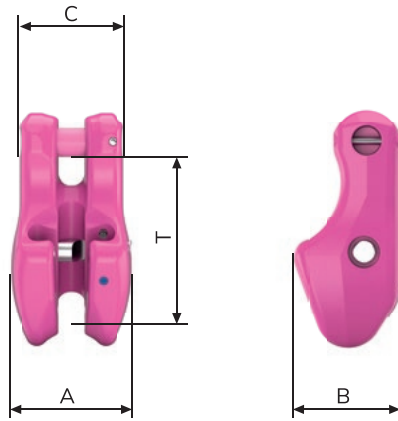

PRODUCT FEATURES

- For VIP chain 20, 22 and 28 mm is only the standard shortening claw in VIP-Quality grade is available.
- Ideal support of the chain by the link-shaped bag support – meaning no reduction of WLL.
- Lightweight design.
- The robust, spring-mounted safety bolt prevents the suspended chain from loosening automatically when unloaded or under load.
- Complies with DIN 5692.

Chains	WLL (t)	Designation	A	B	C	T	Weight [kg/pc.]	Order no.
20	16.0	VV 20	117	101	102	140	8.8	7994856
22	20.0	VV 22	117	101	102	140	8.5	7994855
28	31.5	VV 28	150	130	130	170	17.2	7900643

Subject to technical changes!

<p>Attention: Assemble the 1-strand VKZA.</p>	<p>Attention: Assemble the 2-leg VKZA.</p>	
<p>Assembly for Ø 20 and 22: 1-strand – cannot be shortened – captive.</p>	<p>2-strand – can be shortened – captive.</p>	<p>4-strand – can be shortened – captive.</p>



PRODUCT FEATURES

- When welding a load lifted with a crane, danger of current flow is possible.
- Isolating fork head plate → Insulation up to max. 1,000 Volt, by special plastic bearing of the fork shackle bolt, max. operating temperature +80 °C. WLL embossed on isolating fork head plate.

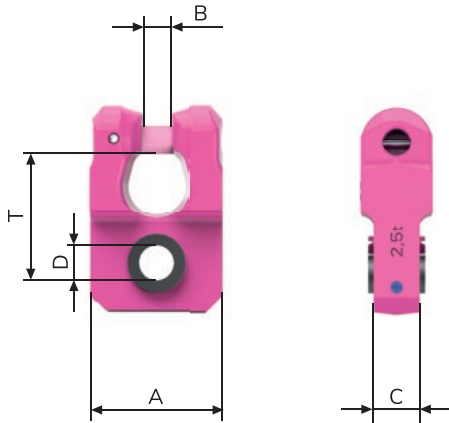

Chains	WLL (t)	Designation	A	B	C	D	T	T 1	T 2	L	Weight [kg/pc.]	Order no. V-SIG	Order no. VGIL
6	1.5	VGIL-6	35	7	16	10	36	71	35	357	1.4	7984258	7984161
8	2.5	VGIL-8	37	9	20	12	37	91	43	431	2.4	7984259	7984162
10	4.0	VGIL-10	46	11	26	16	47	108	55	525	4.3	7984260	7984163
13	6.7	VGIL-13	60	14.5	32	20	54	132	65	643	8.2	7984261	7984164
16	10.0	VGIL-16	70	17.5	37	25	70	166	75	765	13.1	7984262	7984165

Subject to technical changes!

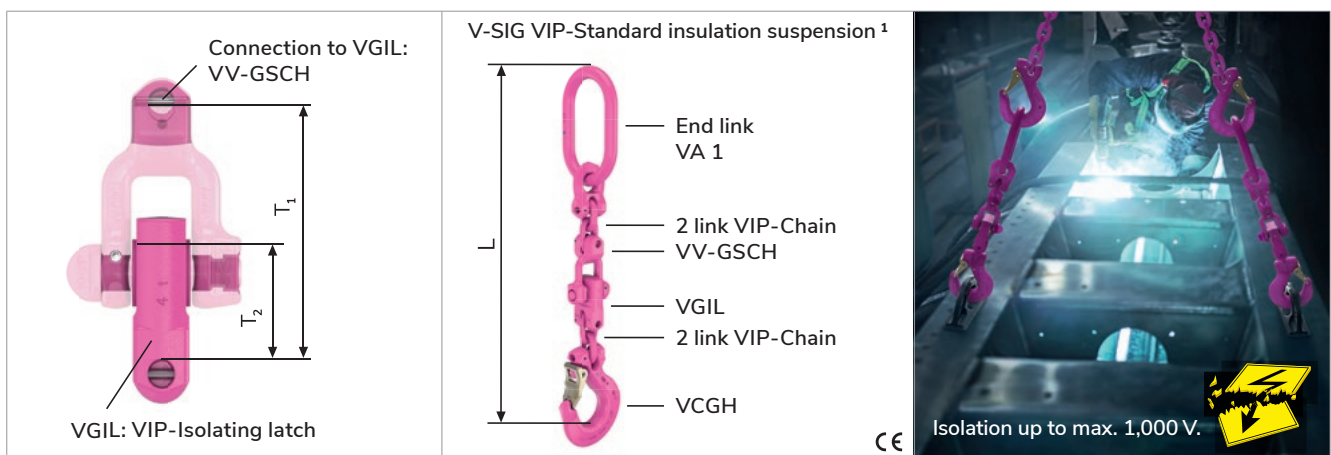

¹ V-SIG VIP-Standard insulation suspension does not contain an identification tag to eliminate the risk of current flow.

Attention!
VV-GSCH is not include in the VGIL order no.

VV-SCH / VC-SCH



VIP-Fool-proof shackle /
VIP-Shackle high-tensile.



CE

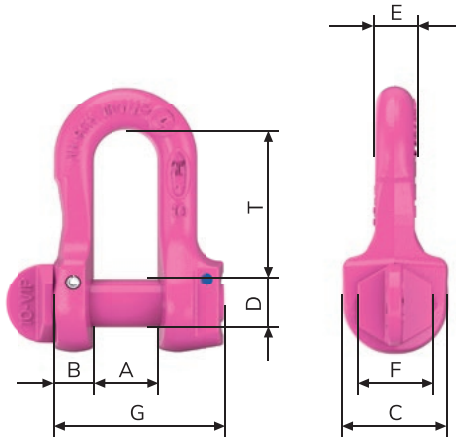

VV-SCH

PRODUCT FEATURES

- High-strength design with integrated safety thread in the shackles bar. Smooth bolt support in the shackle on both sides. Bolts rotatable.
- No bending stress in the thread, but securing function only.
- Pre-assembled with clamping sleeve. Long-term security by driving in a clamping sleeve. Special thread, therefore non-mix-up with other shackles bolts!
- Surface pink powder coated.

VIP-FOOL-PROOF SHACKLES VV-SCH.

Chains	WLL (t)	Designation	A	B	C	D	E	F	G	T	Weight [kg/pc.]	Order no.
6	1.5	VV-SCH 6	14	8	22	10	8	17	36	30	0.1	7100607
8	2.5	VV-SCH 8	17	10	26	12	10	19	44	36	0.2	7100608
10	4.0	VV-SCH 10	21	13	34	16	13	24	56	49	0.4	7100609
13	6.7	VV-SCH 13	27	17	42	20	17	29	75	63	0.8	7100610
16	10.0	VV-SCH 16	33	21	49	24	21	36	90	73	1.4	7100611

Subject to technical changes!



CE

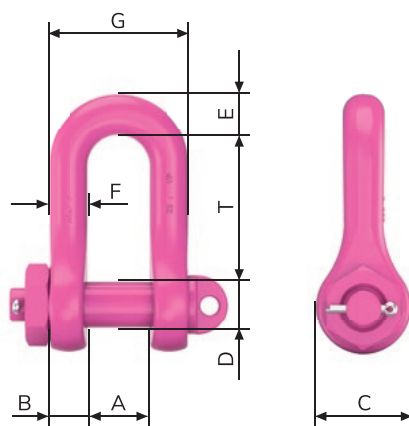

PRODUCT FEATURES

- Shape according to DIN 82 101-C with attached captive nut. Lock via plug-in splint.
- Surface pink powder coated.

VIP-SHACKLES HIGH-TENSILE VC-SCH.

WLL (t)	Designation	A	B	C	D	E	F	G	T	Weight [kg/pc.]	Order no.
16.0	VC-SCH 4.0	42	27	60	30	29	27	96	91	2.8	7906438
25.0	VC-SCH 5.0	47	30	72	36	33	30	107	111	4.4	7906439
31.5	VC-SCH 6.0	53	34	78	39	37	34	121	120	5.9	7984333

Subject to technical changes!

VV-GSCH / OCTOPUS



VIP-Fool-proof shackle /
VIP-Balancing assembly.

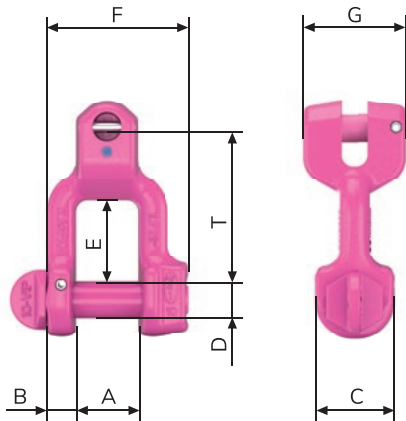

VV-GSCH

PRODUCT FEATURES

- Optimum adjustment – max. jaw width with the smallest shackle bolts.
- Cardan joint largely insensitive to bending due to rotated clevis connection.
- High-strength design with integrated safety thread in the shackles bar. Smooth bolt support in the shackle on both sides. Bolts rotatable.
- No bending stress in the thread, but securing function only.
- Pre-assembled with clamping sleeve. Long-term security by driving in a clamping sleeve. Special thread, therefore non-mix-up with other shackles bolts!
- Surface pink powder coated.

VIP-FOOL-PROOF SHACKLES VV-GSCH.

Chains	WLL (t)	Designation	A	B	C	D	E	F	G	T	Weight [kg/pc.]	Order no.
6	1.5	VV-GSCH 6	17	8	22	10	21	40	28	36	0.15	7102022
8	2.5	VV-GSCH 8	21	10	26	12	32	48	39	48	0.26	7102023
10	4.0	VV-GSCH 10	27	13	34	16	35	62	44	61	0.65	7102024
13	6.7	VV-GSCH 13	33	17	42	20	41	81	59	78	1.4	7102025
16	10.0	VV-GSCH 16	38	21	49	24	49	95	69	96	2.3	7102026
20	16.0	VV-GSCH 20	47	27	60	30	57	119	88	108	4.2	7104284
22	20.0	VV-GSCH 22	53	30	76	36	72	130	95	132	6.5	7102027

Subject to technical changes!



PRODUCT FEATURES

- Guaranteed even load distribution through compensating roller with VV-GSCH 8.
- No overloading and deformation at the element ceilings.

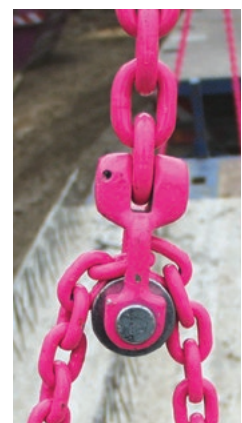

VIP-BALANCING ASSEMBLY OCTOPUS.

Chains	WLL (t)	Designation	Order no. komplett	Order no. fork shackles with deflection roll
8 / 6	5.25	VIP-Octopus 8 x 5,000	7987582	7987366

Subject to technical changes!

VIP-Connection link.

RUD RFID CONNECT IT  **VVS patent**

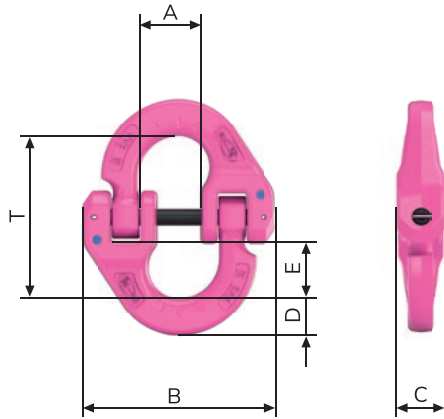

PRODUCT FEATURES

- External connections, e.g. lifting points, shackles, lifting clamps and the chains can be fitted in the lock bracket halves.
- Shape and function registered for patent.
- No kinking of the assembled chain possible.
- The bracket halves can be combined with each other in any way.
- No wandering, no damage to the otherwise usual safety spring or the sleeves of the retaining bolt.
- Patented wear occurrence marks.

VIP-CONNECTION LINK VVS.

Chains	WLL (t)	Designation	A	B	C	D	E	T	Weight [kg/pc.]	Order no.
6	1.5	VVS 6	18	55	13	11	17	46	0.12	7901438
8	2.5	VVS 8	24	70	18	14	23	61	0.29	7901439
10	4.0	VVS 10	28	88	22	17	27	74	0.57	7901440
13	6.7	VVS 13	34	111	28	23	33	93	1.2	7901441
16	10.0	VVS 16	39	130	33	27	37	108	2.0	7901442
20	16.0	VVS 20	42	154	41	34	41	124	3.7	7901443
22	20.0	VVS 22	48	172	44	37	46	138	4.8	7901444
28	31.5	VVS 28	69	228	58	47	67	189	10.6	7901445

Subject to technical changes!



Patented wear occurrence marks.

VIP-Connection link VVS.

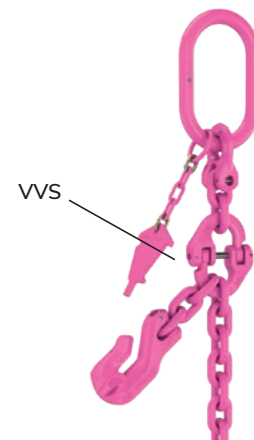

Patented wear occurrence marks which show the discard criteria of BGR 500 / DGUV rule 100-500, chapter 2.8 without measuring.

VIP-DOMINATOR



Connection link for endless chain.

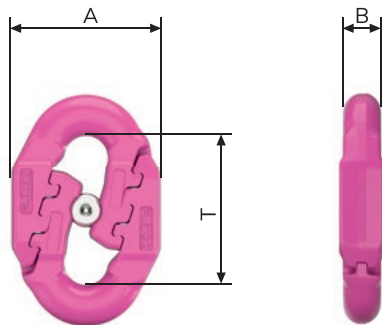

PRODUCT FEATURES

- Robust and torsionally stiff design.
- 100 % crack-free.
- Excellent protection against corrosion.
- Simple hammer assembly.

VIP-Dominator	for chains Ø [mm]	WLL (t)	A	B	T	Weight [kg/pc.]	Order no.
Dominator 22 x 86 for VIP 20 x 60	20	16.0	85	26	86	1.2	56295
Dominator 26 x 92 for VIP 22 x 66	22	20.0	95	33	92	1.8	58915
Dominator 34 x 126 for VIP 28 x 84	28	31.5	119	40	126	4.1	58917

Subject to technical changes!

ENDLESS CHAINS WITH VIP-DOMINATOR.

	VKR-D	Ø 20 mm	Ø 22 mm	Ø 28 mm
	Endless chain with choke hitch	25.6	32.0	50.0
	0-45°	17.6	22.0	35.5
	45-60°	12.8	16.0	25.0

WLL in [t]

Subject to technical changes!

Use of the endless chain.

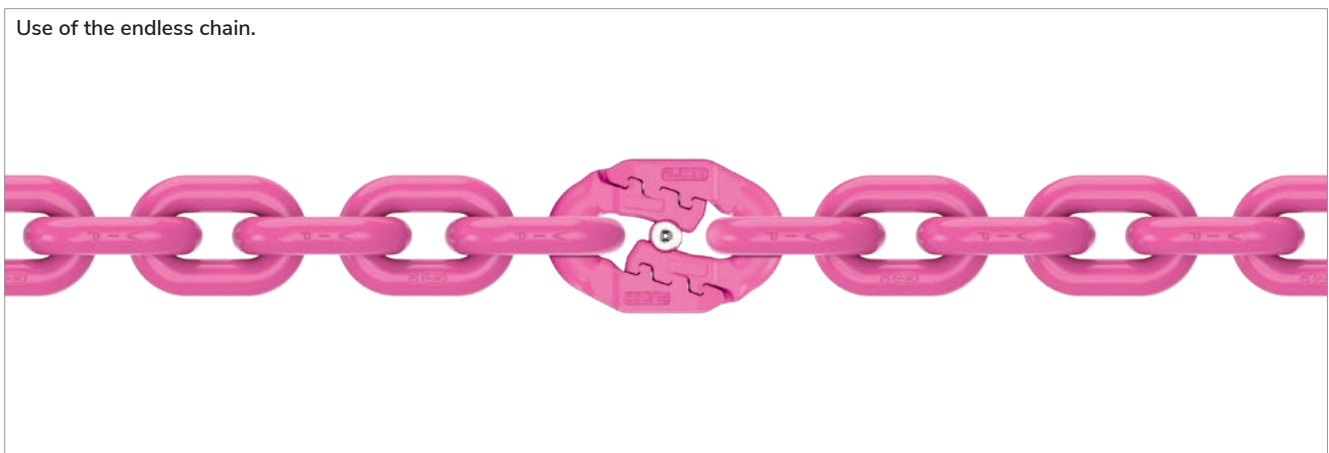

VIP-Balancer.

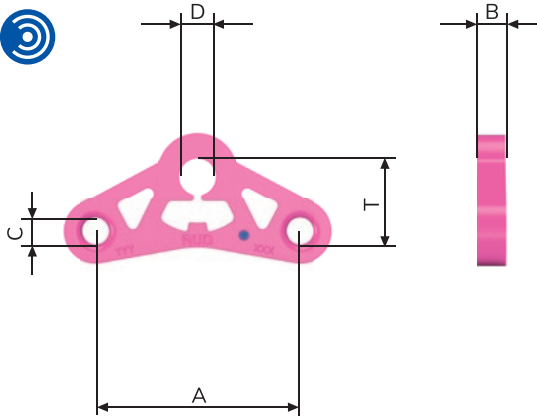

PRODUCT FEATURES

- Balancer connection at top: Connection by shackles.
- Balancer connection at bottom: VIP-Connection links.
- Easy recognition of the limit tilt angle of 10° due to special shaping on the bottom of the balancer.
- Powder coated in VIP-Pink.
- Detailed information on the VIP-Balancer can be found in the operating manual.

Chains	Designation	WLL balancer [t] 0-45°	A	B	C	D	T	Weight [kg/pc.]	Order no.
6	VW-6	2.12	110	15	14	21	46	0.49	7904366
8	VW-8	3.5	150	20	18	26	59	1.15	7904369
10	VW-10	5.6	180	25	23	32	76	2.4	7904371
13	VW-13	9.4	240	30	28	38	91	4.37	7904374
16	VW-16	14.0	300	35	32	41	120	8.8	7904254
20	VW-20	22.4	300	45	40	41	129	10.7	7904725
22	VW-22	28.0	350	50	46	54	138	15.4	7904726

Subject to technical changes!

COMPARISON OF VIP-4-STRAND SUSPENSION / VIP 2 X 2-STRAND BALANCER SUSPENSION.

Chains	WLL [t] VIP-4-Strand suspension 0-45°	WLL [t] VIP-2 x 2-Strand balancer suspension up to $\beta = 45^\circ$
6	3.15	4.2
8	5.25	7.0
10	8.4	11.2
13	14.1	19.0
16	21.2	28.0
20	33.6	45.0
22	42.0	56.0

Subject to technical changes!

DESIGN OF VIP-BALANCER HEAD VWK-2S.

Chains	Designation VIP-Balancer head ^(A)	Dimensions of VAK and IA link	Connection at top	Connection at bottom	Division Balancer head L1	Weight Balancer head [kg/pc.]	Order no. VWK balancer head
6 ¹	VWK-2S-6	18 x 75 x 135	VV-SCH10 (4.0 t)	VVS 6	276	1.95	7904502
8 ¹	VWK-2S-8	22 x 90 x 160	VV-SCH13 (6.7 t)	VVS 8	343	3.99	7904503
10 ²	VWK-2S-10	26 x 100 x 180	VV-SCH16 (10.0 t)	VVS 10	403	7.35	7904504
13 ²	VWK-2S-13	32 x 110 x 200	VC-SCH 4.0 (16.0 t)	VVS 13	475	13.42	7904505
16 ²	VWK-2S-16	36 x 140 x 260	VC-SCH 5.0 (25.0 t)	VVS 16	599	23.53	7904506
20 ²	VWK-2S-20	51 x 130 x 350	VC-SCH 6.0 (31.5 t)	VVS 20	717	35.32	7904507
22 ²	VWK-2S-22	51 x 130 x 350	Shackles (40.0 t)	VVS 22	823	49.98	7904508

¹ Special suspension links with bi = 190 on request.

² Special suspension links with bi = 250 on request.

Subject to technical changes!

DESIGN OF VIP-BALANCER HEAD VAK-2S.

Chains	Designation VIP 2-strand master link for balancer suspension [ⓑ]	Dimensions of VAK and VA link	Division 2-strand VAK L2	Weight 2-strand VAK [kg/pc.]	Order no. VIP-Balancer
6 ¹	VAK 2S-6	18 x 75 x 135	217	1.36	7904509
8 ¹	VAK 2S-8	22 x 90 x 160	268	2.4	7904510
10 ²	VAK 2S-10	26 x 100 x 180	311	4.0	7904511
13 ²	VAK 2S-13	32 x 110 x 200	373	6.9	7904512
16 ²	VAK 2S-16	36 x 140 x 260	470	11.5	7904513
20 ²	VAK 2S-20	51 x 190 x 350	614	32.8	7904514
22 ²	VAK 2S-22	51 x 190 x 350	644	35.0	7904515

¹ Special suspension links with bi = 190 on request.

Subject to technical changes!

² Special suspension links with bi = 250 on request.

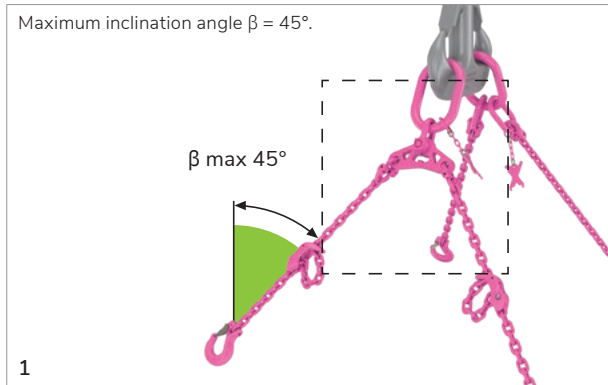

PLEASE NOTE THE FOLLOWING WHEN USING THE VIP-BALANCER SUSPENSION:

- The load must be symmetrical.
- The inclination angle β must not be greater than 45° (see diagrams 1 and 2).
- The inclination of the balancer must not be greater than 10° (see diagrams 3, 4 and 5).
- Detailed information on the VIP-Balancer can be found in the operating manual.
- Higher WLL at $\beta = 15^\circ$ or $\beta = 30^\circ$ see operating manual.

With a 4-strand suspension, a maximum of only three strands can be assumed to be load-bearing. In unfavourable cases, only two strands are used.

Our TIP: When using 2 x 2-strand suspensions in the configuration shown, an even load distribution to all four strands and a 33% higher WLL is achieved compared to a standard 4-strand suspension.

Attention: The 2-strand suspension with balancer may not be used by itself as a 2-strand suspension. Work equipment for lifting loads must prevent the unintentional dangerous movement of the load.

Ask the manufacturer about asymmetric load cases. We are pleased to advise you!

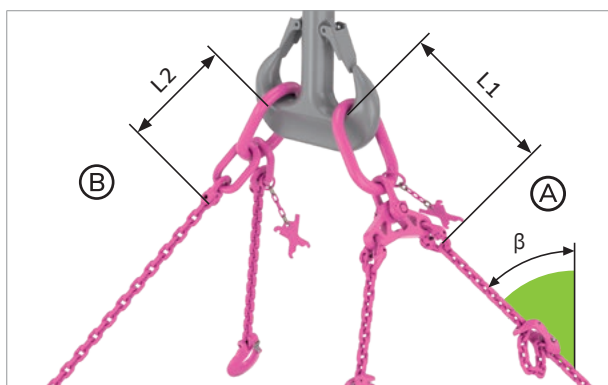
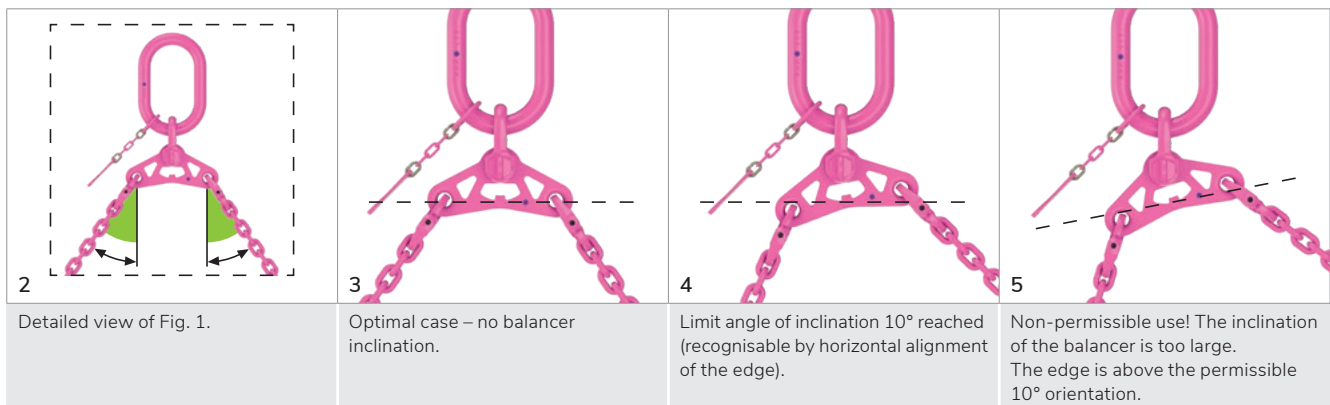

DESIGN OF VIP-BALANCER VWK-2S [Ⓐ] CONSISTING OF:

- VA link with KZA.
- VIP-Shackles.
- VIP-Balancer.
- 2 VIP-Connection links.

VCB

VIP-Chain block.

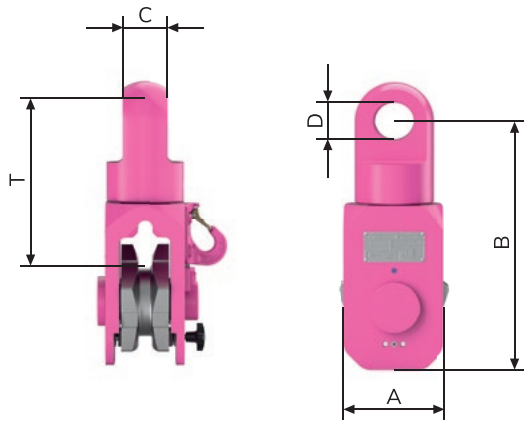

PRODUCT FEATURES

- Pentagon chaped wheel for the deviation of chains.
- Ball-bearing suspension for shackles.
- Small size.
- Connection with high-strength shackles.
- Replaces wire rope snatch blocks.
- Decelerated Pentagon wheel to avoid that chains runs to one side when no load is applied.
- One application is positioning tower segments of wind turbines.

We are pleased to advise you on your lifting tasks!

Chains Ø	Designation	WLL (t)			Connection at top			A	B	T	Weight [kg/pc.]	Order no.
		0-7°	7-20°	20-45°	Thickness C	Drilled Ø D	Connection link					
16	VCB-16	20.0	18.5	14.0	50	45	VV-GSCH-22	135	318	Approx. 196	25.0	7903925
22	VCB-22	40.0	37.5	28.0	80	68	Bow shackles 42.5 t	175	436	Approx. 270	56.0	7900835
28	VCB-28	63.0	58.0	45.0	100	75	Bow shackles 55 t	220	527	Approx. 339	100.0	7906959

Subject to technical changes!



VIP-Control link.

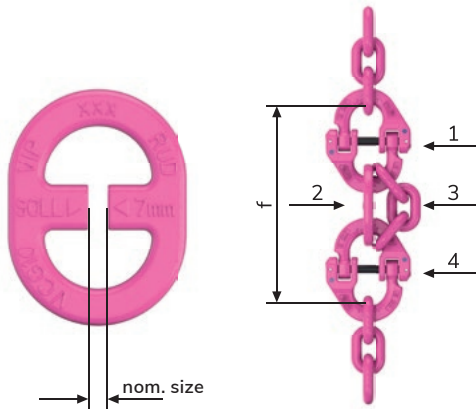

PRODUCT FEATURES

- Immediate permanent visual indication of overload – through the specially calibrated RUD control link VCG. Installed stationary, but easy to replace with connection link VVS – consisting of:
 - 1 Patented connection link VVS simple hammer assembly.
 - 2 Control link VCG and calibrated slot width (target ... mm). With indication bars.
 - 3 Chain VIP, 3 link. Additional safety element in the parallel connection.
 - 4 Patented connection link VVS simple hammer assembly.

CONTROL LINK VCG.

Ø chains des.	WLL (t)	Calc. dimensions target (mm)	Weight [kg/pc.]	Order no.
VCG-6	1.5	4	0.06	7987623
VCG-8	2.5	6	0.1	7987046
VCG-10	4.0	7	0.2	7987626
VCG-13	6.7	10	0.4	7988245
VCG-16	10.0	11	0.7	7989743
VCG-20	16.0	12	1.1	7992549
VCG-22	20.0	16	1.9	7992551

Subject to technical changes!

OVERLOAD CONTROL VCG (COMPLETE).

Nominal thickness chains (mm)	WLL (t)	Single parts	Construction length f (mm)	Weight [kg/pc.]
6	1.5	VVS VCG 3-link-chains VVS	115	0.3
8	2.5		151	0.5
10	4.0		198	1.2
13	6.7		232	2.1
16	10.0		291	4.5
20	16.0		345	8.8
22	20.0		382	12.1

Subject to technical changes!

Application note:

Immediate permanent visual indication of overload – through the specially calibrated RUD control link VCG.

Do not exceed the permissible WLL!
The calibrated slot width corresponds to the specified nominal dimension.

Chain strand overloaded!
Clearly visible on the indication bar. **The slot width becomes smaller** with increasing overload.

With closed bars the WLL is exceeded by 80–100 %!

If the two indicator bars have not yet collided after overload has occurred (slot width > 0.5 mm), the user can install a new control element. If these kinds of overload are repeated, stronger chains must be used. If the indicator bars collide or even protrude, the chains must be taken out of operation and checked according to DGUV rule 100-500 (BGR 500).

VIP-Spreader bar fixed.

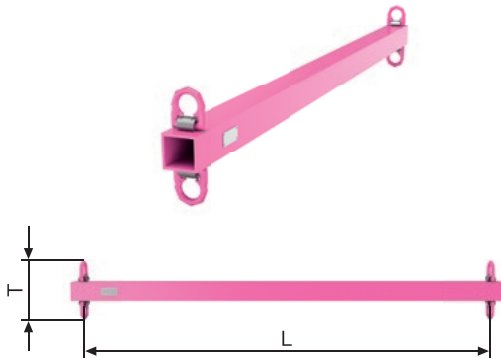

PRODUCT FEATURES

- Strut also available with chain suspension. Please state the version of master link and the required inclination angle β with your order!
- Surface: Usable length L up to 2,500 mm pink powder coated.
- Usable length L over 2,500 mm yellow painted.

Chains	Designation	Maximum possible usable length Lmax.	T	WLL (t)		Support [kg/pc.]	Order no.
				0-45°	45°-60°		
6	VSRS-6	500-4,000	190	2.1	1.5	Depending on usable length L	86 00 120
8	VSRS-8	500-5,000	240	3.5	2.5		86 00 121
10	VSRS-10	500-5,000	320	5.6	4.0		86 00 122
13	VSRS-13	1,000-5,000	350	9.5	6.7		86 00 123
16	VSRS-16	1,000-5,000	250	14.0	10.0		86 00 124
20	VSRS-20	1,000-5,000	285	22.4	16.0		86 00 125
22	VSRS-22	1,000-5,000	290	28.0	20.0		86 00 126

Subject to technical changes!

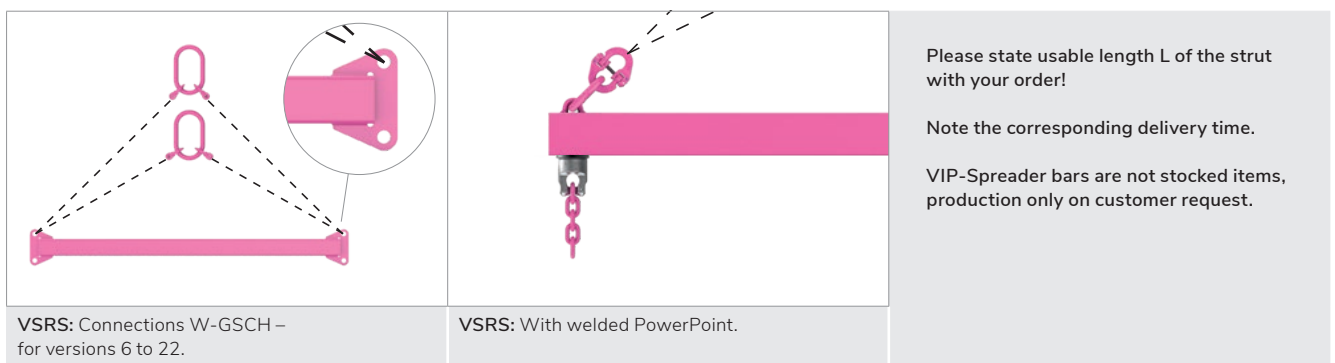
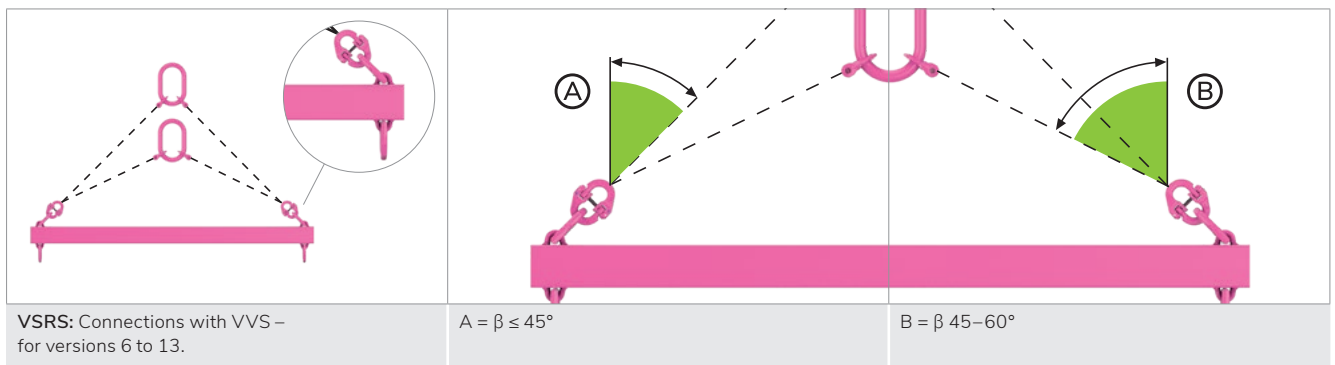

VSRV



VIP-Spreader bar adjustable.

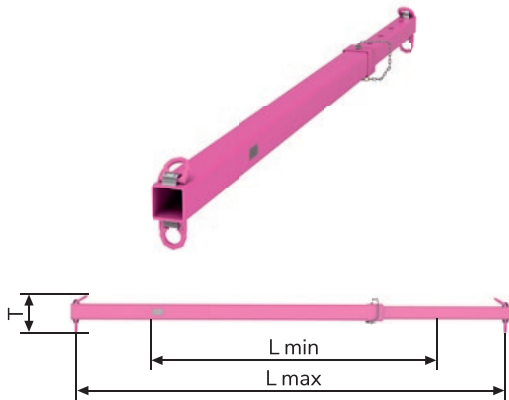

PRODUCT FEATURES

- Please state usable length L_{max} of the strut with your order.
- Adjustable strut also available with chain suspension. Please state the version of master link and the required inclination angle β with your order!
- Surface: pink powder coated.
- L_{min} depends on L_{max} and the nominal size!

Chains	Designation	Maximum possible usable length L_{max}	T	WLL (t)		Support [kg/pc.]	Order no.
				0-45°	45°-60°		
6	VSRV-6	1,500-4,000	200	2.1	1.5	Depending on usable length L	86 00 120
8	VSRV-8	1,500-4,000	250	3.5	2.5		86 00 121
10	VSRV-10	1,500-4,000	330	5.6	4.0		86 00 122
13	VSRV-13	1,500-4,000	360	9.5	6.7		86 00 123
16	VSRV-16	1,500-4,000	250	14.0	10.0		86 00 124
20	VSRV-20	1,500-4,000	285	22.4	16.0		86 00 125
22	VSRV-22	1,500-4,000	290	28.0	20.0		86 00 126

Subject to technical changes!

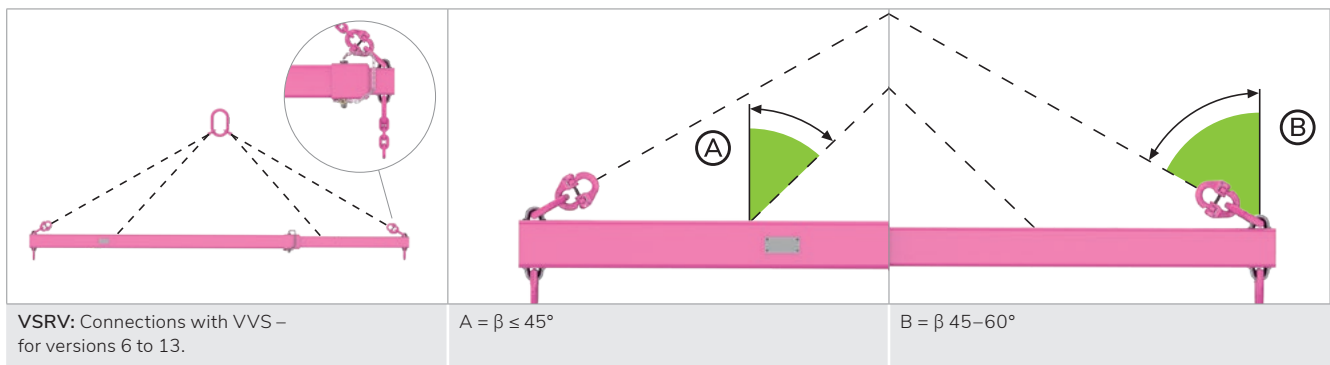

VCGH

VIP-COBRA hook with safety latch.

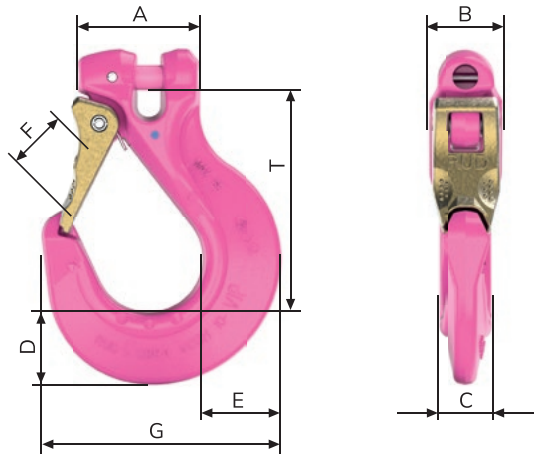

PRODUCT FEATURES

- Extremely robust, further improved version.
- No protruding hook tip.
- Forged, tempered safety latch snaps into the tip of the hook, thus protecting against lateral bending.
- Triple coiled, stainless double jaw spring.
- Thickened hook tip prevents incorrect use.
- Wear occurrence edges on both sides.

Chains	WLL (t)	Designation	A	B	C	D	E	F	Fmax.	G	T	Weight [kg/pc.]	Order no.
6	1.5	VCGH-6	38	22	16	20	24	25	45	72	76	0.4	7100498
8	2.5	VCGH-8	50	28	20	28	32	30	52	95	97	0.8	7100499
10	4.0	VCGH-10	60	36	26	36	39	35	65	118	108	1.5	7100500
13	6.7	VCGH-13	76	46	30	37	48	40	73	135	126	2.8	7100501
16	10.0	VCGH-16	83	56	36	49	58	48	87	161	152	4.7	7100502
20	16.0	VCGH-20	112	68	50	69	78	63	114	218	195	10.0	7103385
22	20.0	VCGH-22	117	78	50	74	83	63	114	223	198	11.9	7101603
28	31.5	VCGH-28	150	101	69	88	109	90	155	295	275	26.4	7900638

Subject to technical changes!

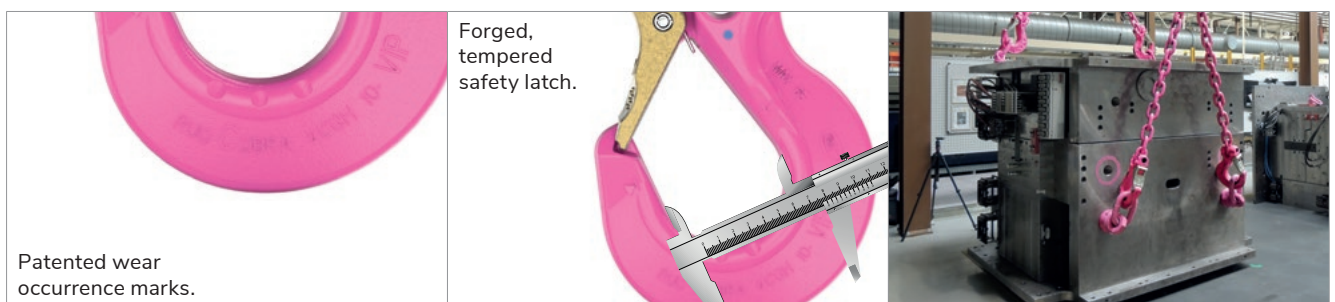

- Patented wear occurrence marks, which, without measuring, indicate the discard criteria of the DGVU rule 100-500 (BGR 500), chapter 2.8.
- Fmax. = Distance of marking points for quick detection of unacceptable deformation.

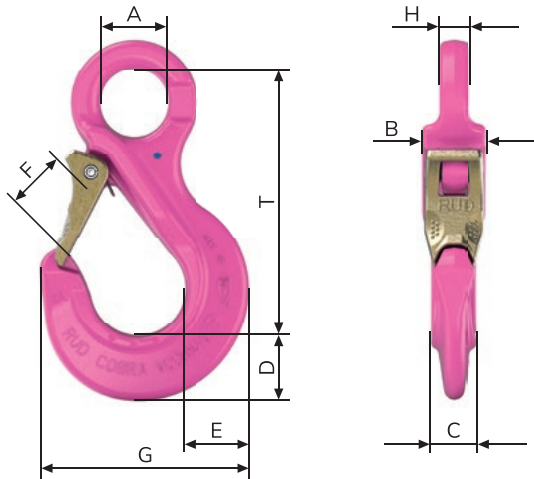

PRODUCT FEATURES

- For special wire ropes, VIP-Chain suspensions, PowerPoint combinations or universal swivels.
- Extremely robust, compact version with pink powder coating.
- No protruding hook tip
- Forged, tempered safety latch snaps into the tip of the hook, thus protecting against lateral bending.
- Wear occurrence edges on both sides.
- Triple coiled, stainless double jaw spring.
- Thickened hook tip prevents incorrect use.

Chains	WLL (t)	Designation	A	B	C	D	E	F	Fmax.	G	H	T	Weight [kg/pc.]	Order no.
4	0.63	VCÖH-4	18	18	12	13	14	18	-	53	8	75	0.14	8502323
6	1.5	VCÖH-6	24	22	16	22	24	25	45	73	11	98	0.5	8502203
8	2.5	VCÖH-8	32	28	20	28	32	30	52	95	13	126	0.8	8502142
10	4.0	VCÖH-10	38	36	26	36	39	35	65	118	17	150	1.6	8502145
13	6.7	VCÖH-13	48	45	30	37	48	40	73	135	21	170	2.9	8502204
16	10.0	VCÖH-16	63	56	36	49	58	48	87	161	27	208	4.2	8502146

Subject to technical changes!

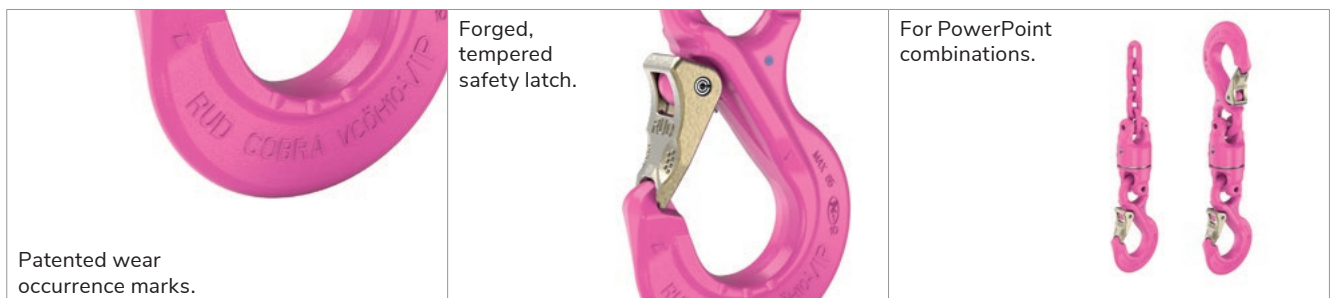

- Patented wear occurrence marks, which, without measuring, indicate the discard criteria of the DGVU rule 100-500 (BGR 500), chapter 2.8.
- Fmax. = Distance of marking points for quick detection of unacceptable deformation.

VIP-Foundry hook.

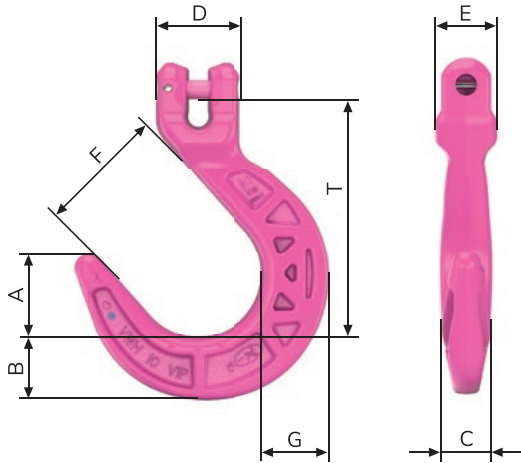

PRODUCT FEATURES

- Also referred to as foundry or container hooks.
- With much larger jaws like VCGH, but without safety element.
- Weight optimised by Skeletto design.
- Robust cross-section (dimension C/G) against higher bending forces.
- Chains protection and wear occurrence edges dimension "E".
- Complete with connection bolts and clamp pin pre-assembled.
- Marking points to check the size of the jaw width!

Chains	WLL (t)	Designation	A	B	C	D	E	F	Fmax.	G	T	Weight [kg/pc.]	Order no.
6	1.5	VWH-6	32	24	24	32	22	50	71	24	90	0.44	7100210
8	2.5	VWH-8	41	31	24	42	29	64	91	32	121	1.0	7100211
10	4	VWH-10	49	37	30	50	36	76	108	40	143	1.8	7100212
13	6.7	VWH-13	58	44	31	64	46	90	127	47	168	3.0	7100213
16	10.0	VWH-16	66	50	39	75	56	100	145	55	190	4.7	7100214
20	16.0	VWH-20	96	80	74	102	80	136	203	80	277	15.1	7998157
22	20.0	VWH-22	96	80	74	102	80	136	203	80	277	15.3	7998158

Subject to technical changes!



- Only use where unintentional removal is not possible (risk assessment).
- Not suitable for transport by persons.
- With patented wear occurrence marks.
- Fmax. = Distance of marking points for quick detection of unacceptable deformation.

VAGH-S

VIP-Self-locking hook.

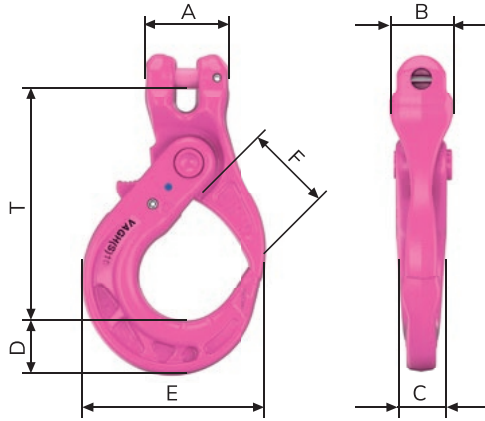

PRODUCT FEATURES

- Weight optimised due to innovative structure design (Skeletto).
- Ergonomically designed locking lever, user-friendly and with non-slip surface – no danger of crushing.
- Wear occurrence ribs – to protect the first chain link.
- Thickened hook tip – prevents dangerous hook tip WLL.
- Marking points to check the size of the jaw width!

Chains	WLL (t)	Designation	A	B	C	D	E	F	Fmax.	T	Weight [kg/pc.]	Order no.
8	2.5	VAGH-(S)-8	40	30	27	28	97	44	60	121	1.0	7900046
10	4.0	VAGH-(S)-10	49	37	30	31	107	48	66	135	1.5	7900047
13	6.7	VAGH-(S)-13	61	48	36	40	133	61	81	169	2.9	7900048

Subject to technical changes!

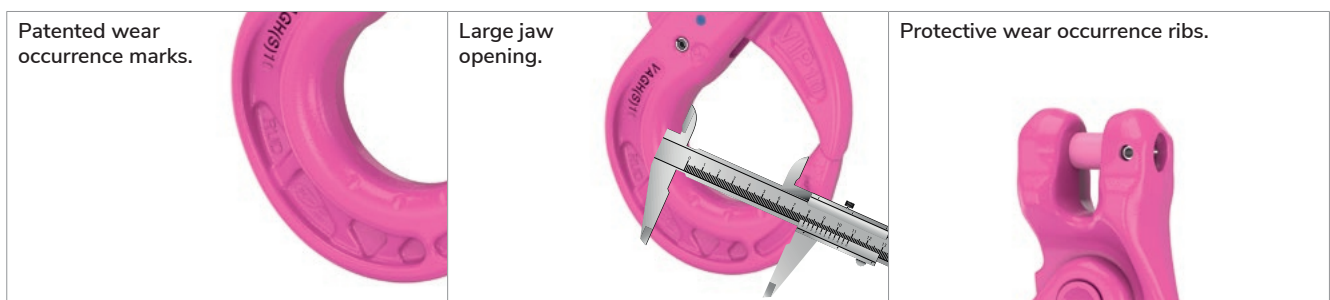

- Patented wear occurrence marks, which, without measuring, indicate the discard criteria of the DGVU rule 100-500 (BGR 500), chapter 2.8.
- Fmax. = Distance of marking points for quick detection of unacceptable deformation.

VBMHWA



VIP-Bale hook.

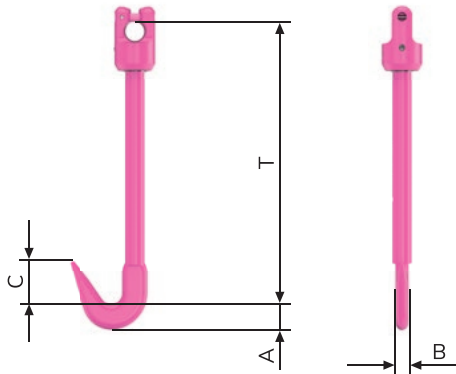

PRODUCT FEATURES

- Lateral flattenings at the hook allow an easy insertion into structural steel meshes. Direct chain connection with a fool-proof clevis section and the integrated swivel with a ball bearing ensure untwisting of chain.
- Only bundled structural steel meshes must be transported.
- Do not lift at strapping or lacing.
- Not suitable for transport above persons. When structural steel mesh bale hooks hooks, increased caution must be exercised or a risk assessment must be carried out before use.

Chains	WLL (t)	Designation	A	B	C	T	Weight [kg/pc.]	Order no.
8	2.5	VBMHWA-8	35	18	61	381	2.5	7991478
10	4.0	VBMHWA-10	35	18	61	381	2.5	7989017

Subject to technical changes!

Flattening the back of the hook facilitates horizontal insertion of the hook into bale hooks.



Automatic unscrewing of the chains through direct chains connection to non-mix-up clevis connection, with integrated ball-bearing mounted swivel.



HWA

VIP-Hoist swivel adapter.



PRODUCT FEATURES

- Equipped with original Demag ball bearing.
- Made of high-strength tempered special steel.
- Tested according to EN 1677.
- Suits 1-leg chain blocks and 2-leg bottom blocks.
- Suits all VIP-Clevis connection kit parts.
- The 6 mm clevis connection suits also IAGH-6 ICE-Automatic hooks.

FOR DEMAG-DK AND DC LIFTING GEAR.

WLL (t)	Designation	Information	Clevis connection	Weight [kg/pc.]	Order no.
0.4	HWA-6-DK-400 ¹	DC 1+2 to 250 kg	6	0.15	7985570
0.8	HWA-6-DK-800 ¹	DC 5 to 500 kg	6	0.3	7985571
0.8	HWA-6-DK-800 ¹	DC 5 to 500 kg	8	0.4	7985572
1.25	HWA-6-DK-1250 ¹	DC 10+20 to 1,000 kg	8	0.55	7985573
2.5	HWA-6-DK-2500 ¹	DC 20 ² to 1,000 – 2,000 kg	10	0.9	7985574
5.0	HWA-6-DK-5000		13	1.3	7985575

¹ Also suitable for DC-Pro, DCS-Pro and DC-COM.

² DK 2500 / DC 20: Only in connection with DEMAG DK base blocks.

Subject to technical changes!

FOR DEMAG-PK LIFTING GEAR.

WLL (t)	Designation	Clevis connection	Weight [kg/pc.]	Order no.
0.25	HWA-6-PK-(1)	6	0.12	51287
0.5	HWA-6-PK-(2)	6	0.15	51288
0.5	HWA-8-PK-(2)	8	0.28	51293
1.0	HWA-8-PK-(5)	8	0.35	51294
2.0	HWA-10-PK-(10)	10	0.45	51295

Subject to technical changes!



VCH



VIP-Container hook – 12.5 t.



PRODUCT FEATURES

- To suit ISO container corners.
- Permanent connection using VVS or VV-GSCH.
- Separate component for hook suspension.

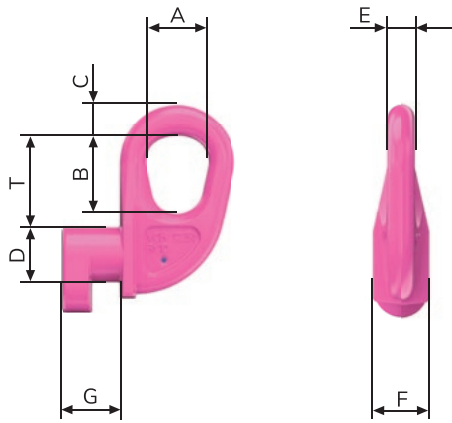

Designation	WLL (t)	A	B	C	D	E	F	G	T	Weight [kg/pc.]	Order no.
VCH-12.5t	12.5	56	70	28	50	24	50	53	83	3.1	7908182

Subject to technical changes!

Area of application
30–60°.

VWH.

For 1D, 1E, 1F containers (< 9 ft), a maximum angle of inclination of 30° at the top corner of the container can be lifted using a 4-strand system.

VCH-K 16

VIP-Container hook – 10.0 t.



PRODUCT FEATURES

- To suit ISO container corners.
- The container hook is equipped with a safety lock.
- It is no longer possible to fall out of the ISO corner when lifting. Simplest handling.
- Insertion: Swing safety latch back, insert container hook in ISO corner, release safety latch. Locks automatically.
- Removal: Swing safety latch back, remove container hook from ISO corner, release safety latch.

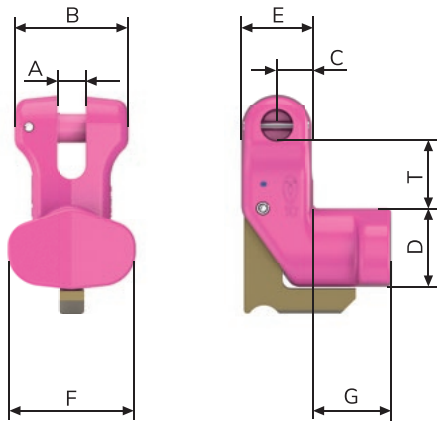

Designation	WLL (t)	A	B	C	D	E	F	G	T	Weight [kg/pc.]	Order no.
VCH-K 16	10.0	18	71	23	50	46	76	48	40	2.35	8504332

Subject to technical changes!

<p>Area of application 0–40°.</p>		<p>VWH.</p>	<p>For 1D, 1E, 1F containers (< 9 ft), a maximum angle of inclination of 30° at the top corner of the container can be lifted using a 4-strand system.</p>
---------------------------------------	--	-------------	---

VCH-SL 22

VIP-Container hook – 20 t.

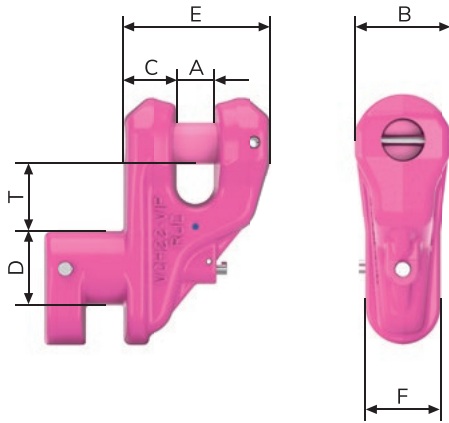

PRODUCT FEATURES

- To suit ISO container corners.
- The container hook is equipped with a patented safety lock.
- It is no longer possible to fall out of the ISO corner when lifting. Simplest handling.
- Insertion: By automatic opening and closing without actuating the safety lock.
- Removal: Only possible with the release bolt actuated.
- VCH-SL 22 to suit ISO container corner. Clevis connection for size 22 VIP-Chain.
- With a VRG-16 reduction, the VIP-Chain 16 can be used.

Designation	WLL (t)	A	B	C	D	E	F	T	Weight [kg/pc.]	Order no.
VCH-SL 22	20.0	24	62	48	50	100	50	45	4.2	8502313

Subject to technical changes!

Area of application
30–60°.

VWH.

For 1D, 1E, 1F containers (< 9 ft), a maximum angle of inclination of 30° at the top corner of the container can be lifted using a 4-strand system.

VERG

VIP-Plug-in connector.



PRODUCT FEATURES

- VERG – for use as a push-in bolt for tool transport or similar lifting methods. In all the places, where only drilled holes are possible to take the load.
- Minimum $\varnothing D$ see table, minimum bolt length L is $2 \times D$. Maximum $\varnothing D = 48$ mm.
- Drilled hole diameter = $D + 1$ mm. Recommended in connection with a spreader bar or cross beam for vertical lifting.

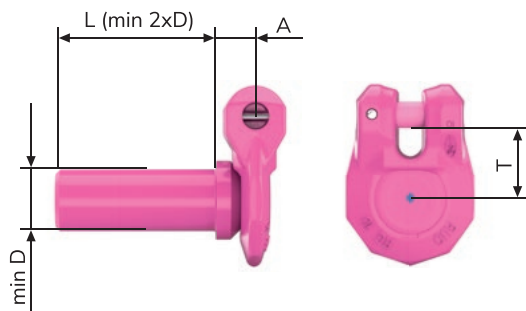

Chains	WLL (t)	Designation	D min.	D ¹	L	A min.	T	Order no.
6	1.5	VERG-6	17	Please state dimensions D and L with your order!		11	20	8600130
8	2.5	VERG-8	22			15	26	8600131
10	4.0	VERG-10	28			18	33	8600132
13	6.7	VERG-13	36			24	42	8600133
16	10.0	VERG-16	45			29	54	8600134

Subject to technical changes!

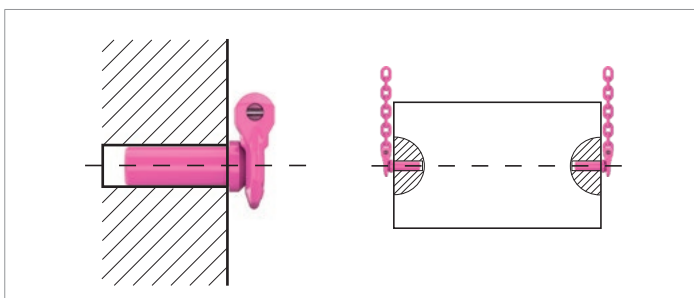

The collar must always remain attached during lifting.

VIP-Plug-in connectors are not stock items. Production on customer request. Note the corresponding delivery times.

VIP-MAXI CONSTRUCTION KIT

Flexibility meets heavy load.

Combine chains, wire ropes and textile lifting means for WLL of up to 126 tonnes with the VIP-MAXI construction kit from RUD. This enables optimum solutions when a maximum of safety and flexibility is required when lifting heavy loads. A special feature in this WLL class is that the suspension can be shortened. Thanks to the forged combination master links with integrated chains connection, a VIP-MAXI suspension can be shortened to a very short nominal length – a clear advantage when space is limited at the top. Strands that can be shortened by a combination with textile or wire rope also ensure high flexibility.

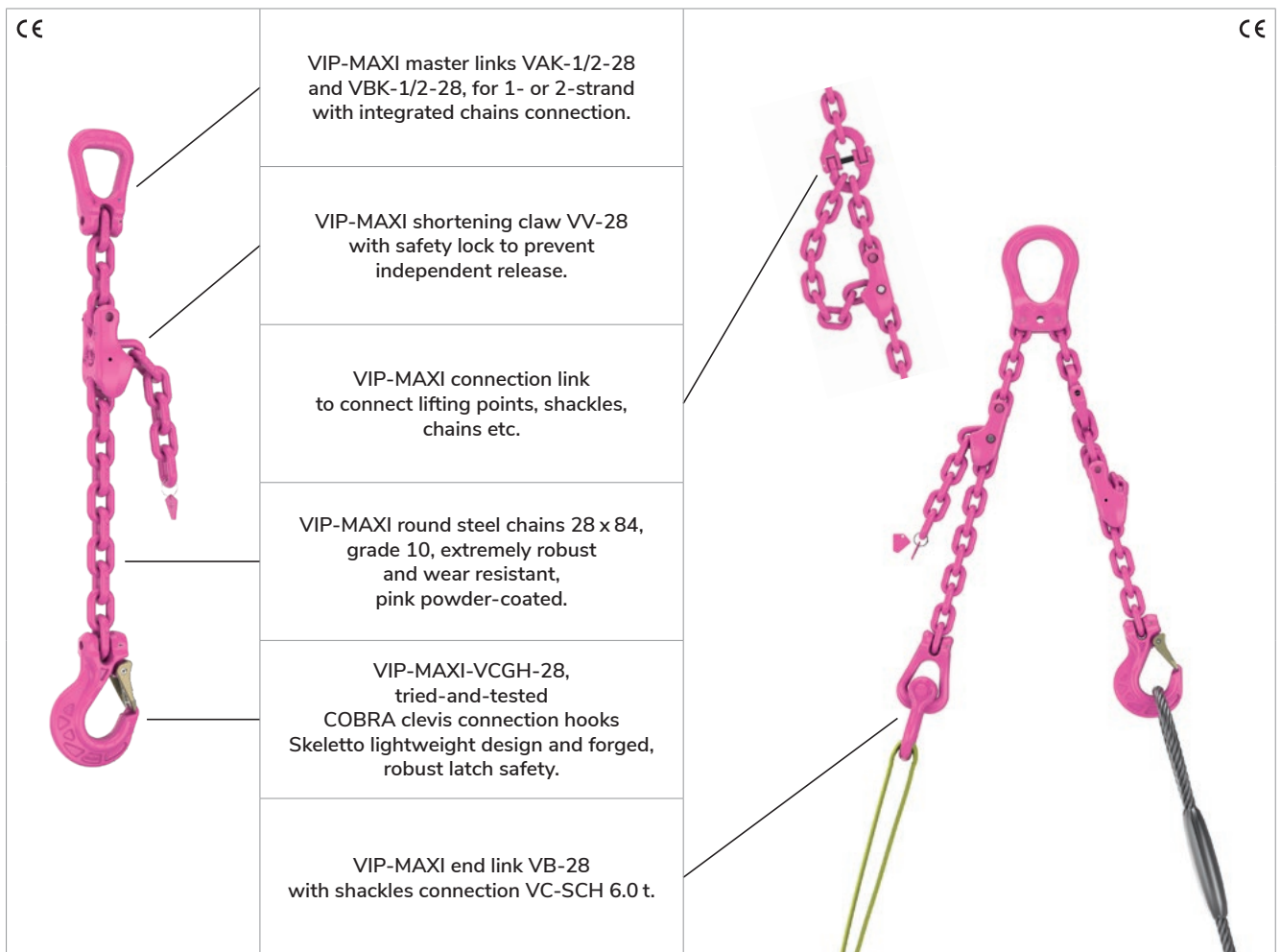

Lifting variants.



Suspension variants.



End components.



VIP-MAXI CONSTRUCTION KIT

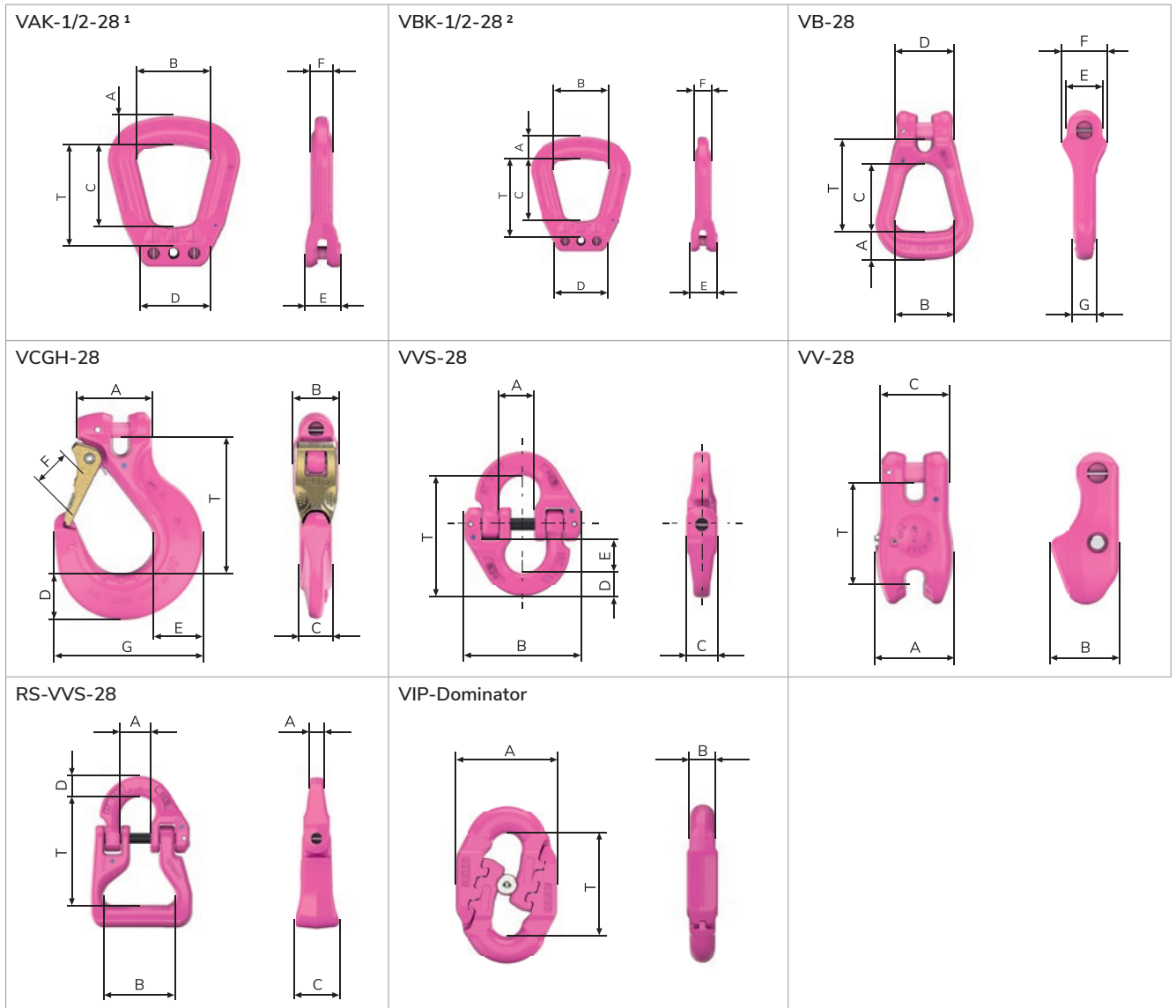

¹ VAK-1/2-28: For single crane hooks DIN 15401 (up to size no. 80) and double crane hooks DIN 15401 (up to size no. 50)

² VBK-1/2-28: For single crane hooks (size 12–32) and double crane hooks (size 12–32)

Chains	WLL (t)	A	B	C	D	E	F	G	T	Weight [kg/pc.]	Order no.
VAK-1 / 2-28	31.5 / 45.0 / 63.0	100	250	280	208	120	76	–	360	64.3	7900642
VBK-1 / 2-28	31.5 / 45.0 / 63.0	60	190	265	240	120	55	–	322	35.0	8504022
VB-28	31.5	62	130	150	130	80	100	52	209	13.7	7900641
VCGH-28	31.5	150	101	69	88	–	90	295	275	26.4	7900638
VVS-28	31.5	69	228	58	47	67	81	–	189	10.6	7901445
VV-28	31.5	150	130	130	–	–	–	–	170	16.9	7900643
RS-VVS-28	31.5	69	163	100	47	33	–	–	245	20.0	7903511
VIP-Dominator	31.5	–	–	40	–	–	–	–	126	4.1	58917

Subject to technical changes!

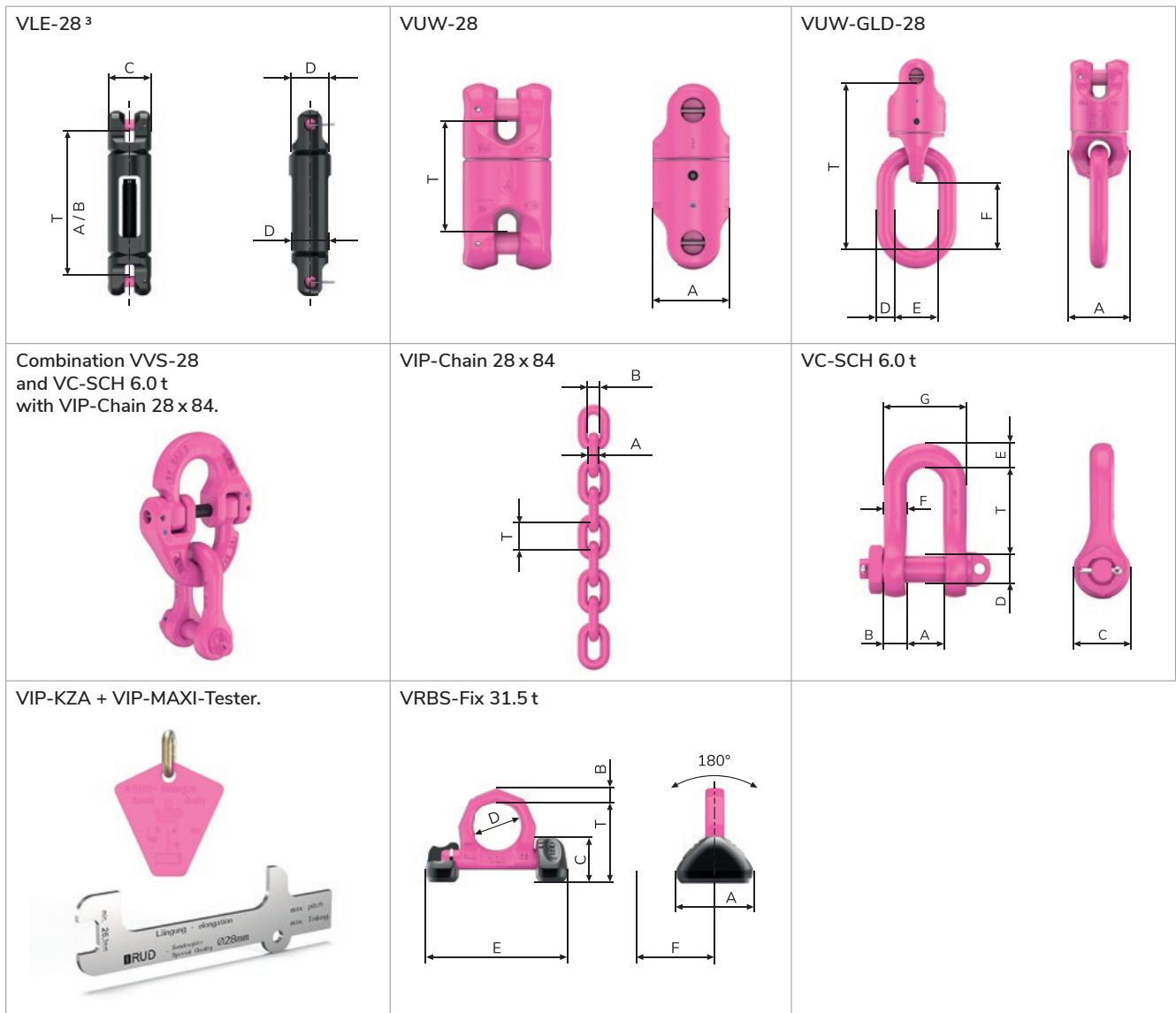

³VLE-28: T = length closed / A = length opened / B = stroke

Chains	WLL (t)	A	B	C	D	E	F	G	T	Weight [kg/pc.]	Order no.
VLE-28	31.5	650	172	138	120	-	-	-	478	44.0	7900772
VUW-28	31.5	148	-	-	-	-	-	-	183	27.3	7903435
VUW-GLD-28	31.5	153	-	-	46	110	169	-	416	32.1	7903436
Combination VVS-28 and VC-SCH 6.0t	31.5	-	-	-	-	-	-	-	309	16.5	7901445 + 7984333
VMK 28 x 84	31.5	28	37	-	-	-	-	-	84	18.6	7900670
VC-SCH 6.0	31.5	53	34	78	39	37	34	121	120	5.9	7984333
VIP-KZA	-	-	-	-	-	-	-	-	-	-	7989739
VIP-MAXI-Tester	-	-	-	-	-	-	-	-	-	-	7900709
VRBS-FIX 31.5t	31.5	160	42	99	130	366	195	-	202	18.4	7999302

Subject to technical changes!

VIP-MAXI CONSTRUCTION KIT

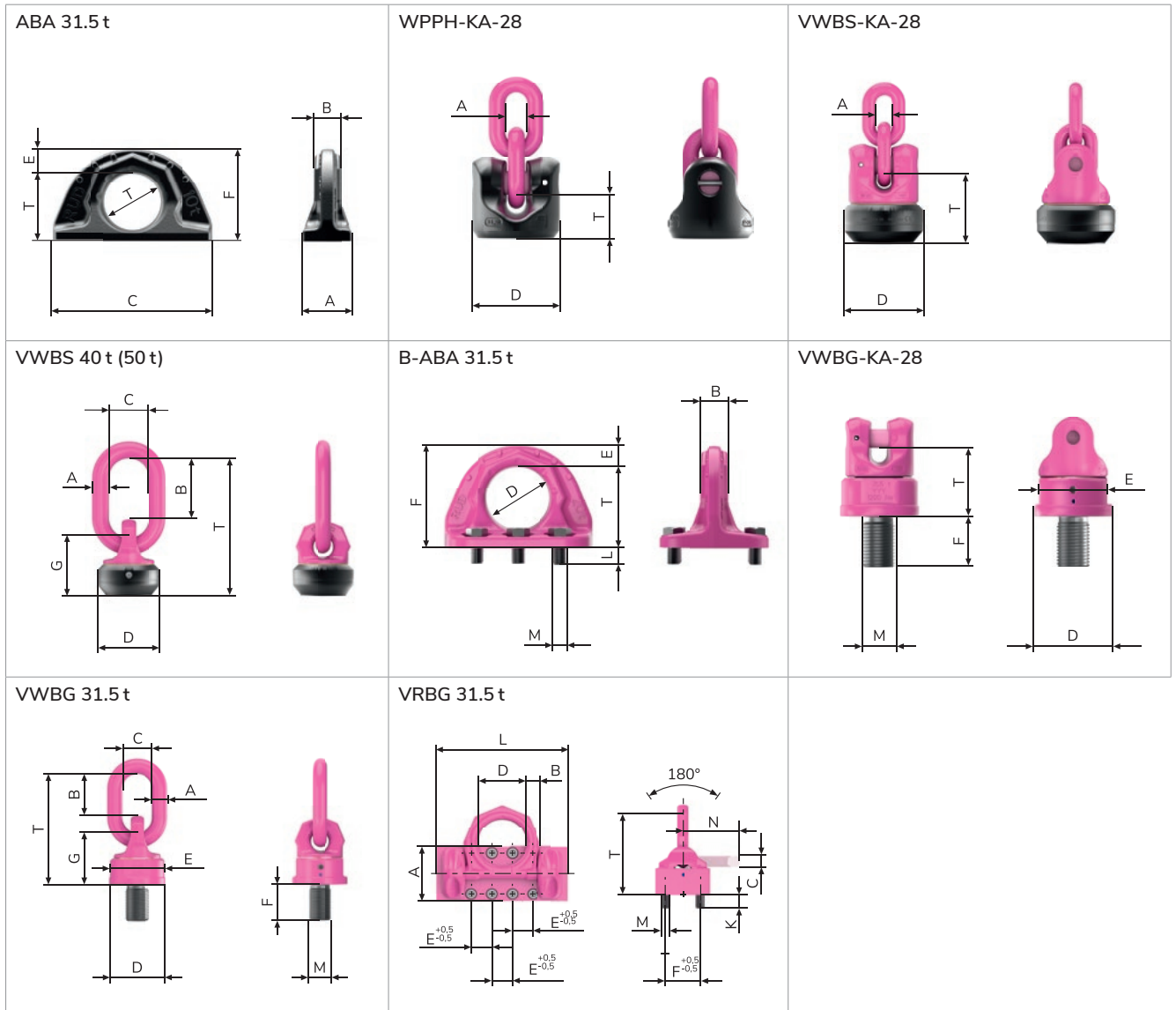

Chains	WLL (t)	A	B	C	D	E	F	G	M	T	Weight [kg/pc.]	Order no.
ABA 31.5t	31.5	108	64	320	130	50	204	-	-	154	18.3	7902175
WPPH-KA-28	31.5	28	-	-	148	-	-	-	-	81	12.0	7903438
VWBS-KA-28	31.5	28	-	-	170	-	-	-	-	147	24.0	7903440
VWBS 40t (50t)	40.0	46	170	110	170	-	-	161	-	380	27.9	7903650
B-ABA 31.5t	31.5	230	64	320	130	50	215	175	30	165	29.5	7906271
VWBG-KA-28	31.5	-	-	-	170	145	108	-	72	146	26.4	7903437
VWBG 31.5t	31.5	46	130	90	170	145	108	159	72	338	29.9	7900097
VRBG 31.5t	31.5	180	42	42	130	75	120	400	30	265	67.0	7985866

Subject to technical changes!

Inclination angle β	0°	0°	0-45°	>45-60°	0-7°	>7-45°	0-45°
Load factor	1	2	1.4	1	4	2.8	2.1
WLL (t)	31.5	63.0	45.0	31.5	126.0	88.0	67.0

Inclination angle β	0-7°	>7-45°	>45-60°	0-7°	>7-45°	0-7°	>7-45°	0-7°
Load factor	2	1.4	1	4	2.8	4	2.8	2
WLL (t)	63.0 ¹	45.0	31.5	126.0 ¹	88.0 ¹	126.0 ¹	88.0 ¹	63.0 ¹



When used in suspension, it must be ensured that the loads cannot shift dangerously or fall down (BetrSichV, Appendix 1 according to § 7).

- According to BGR 500 / DGUV rule 100-500, the single strand WLL applies in the event of asymmetrical loading of a multiple strand suspension.
- ¹ Sling or endless chains: For bollard, bolt or shackle diameters > 3 x t (250 mm) the WLL of a double strand can be assumed. For smaller diameters (edge load) the WLL must be reduced by 20 %.
- Please state the use as a double strand on your order!

VIP-MINI CONSTRUCTION KIT

Amazing lifting for small loads.

SUSPENSION FIXED / VIP-MINI MASTER LINKS.



Chains	WLL (t)	Designation	A	B	C	D	E	T	Weight [kg/pc.]	Order no.
4	0.63	VAK 1/2-4	9	30	28	20	6	55	0.1	79 84 445
4	1.32	VAK 3/4-4	10	35	60	-	-	106	0.3	79 84 447

Subject to technical changes!

SUSPENSION ADJUSTABLE – VIP-MINI-LIFTER.



Chains	WLL (t)	Designation	A	B	C	T	Weight [kg/pc.]	Order no.
4	0.88 / 0.63	VML 2-4	10	30	-	66	0.26	79 84 478
4	1.32 / 0.95	VML 4-4	10	35	60	150	0.85	79 84 479

Subject to technical changes!

VIP-MINI END COMPONENTS.

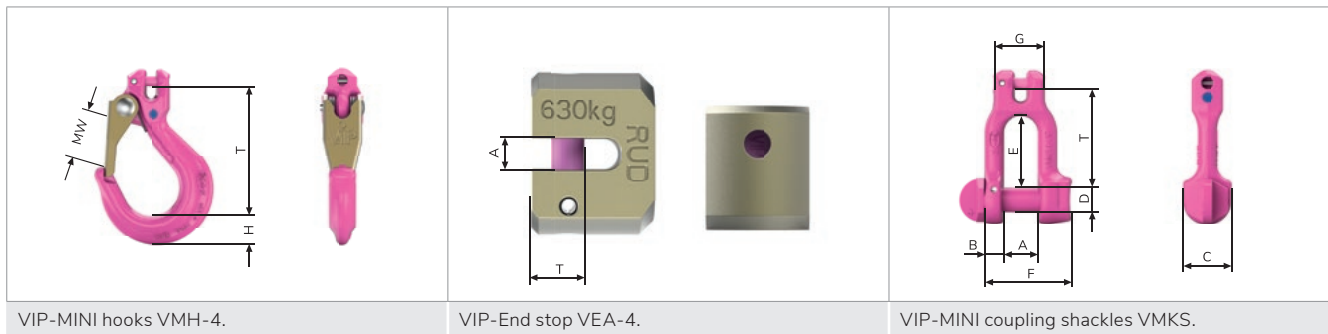

Chains	WLL (t)	Designation	A	B	C	D	E	F	G	T	Weight [kg/pc.]	Order no.
4	0.63	VMH-4	60	14	12.5	13	14	18	52	56	0.12	79 84 439
4	0.63	VMKS-4	14	8	20	10	30	36	21	42	0.12	79 85 243
4	0.63	VEA-4	4.8	-	-	-	-	-	-	8	0.05	79 90 215

Subject to technical changes!

A WLL of up to 1,320 kilograms is fully adequate for a variety of lifting tasks. This is where the VIP-MINI construction kit plays to its strength. With a nominal thickness of only 4 millimetres, the VIP-MINI-chains are extremely slim and light, making it ergonomic in use. This makes it the ideal solution for lifting tasks that occur several times a day – for example assembly work in industrial production.

However, thanks to the specially developed MINI-Lifter, the system also offers enormous advantages for simple lifting or attachment tasks. The combination of master link and shortening element allows the chain strand to be shortened to the desired length extremely easily and quickly. In addition, the low dead weight of the lifting chains often enables higher loads to be lifted with slewing cranes.

RUD VIP-SPARE PARTS

VIP-SAFETY ELEMENTS COBRA CLEVIS CONNECTION HOOKS

Subject to technical changes!

- Consisting of forged safety latch, triple coiled stainless steel double leg spring and safety pin.
- Only available as a complete set.
- Simple assembly/removal with a hammer and driver.

Chains	Designation	[kg/pc.]	Order no.
4	Si-Set VMH-4 ¹	0.04	7987901
6	Si-Set VMH-6	0.04	7100299
8	Si-Set VMH-8	0.07	7100300
10	Si-Set VMH-10	0.09	7100301
13	Si-Set VMH-13	0.15	7100302
16	Si-Set VMH-16	0.24	7100303
20 / 22	Si-Set VMH-20 / 22	0.4	7101604
28	Si-Set VMH-28	1.6	7900640



¹ With rivet pin.

VIP-SPARE PART SET FOR VMEG

Subject to technical changes!

- Spare part set for ICE-/VIP-Recess suspension link consisting of:
 - 1 locking lever
 - 1 spring
 - 2 clamping sleeves

Chains	Designation	Order no.
10 / 13	Spare part set for IMEG-10 / IMEG-13 and VMEG-13	7902648
10 / 13	Spare bolt set IMEG10 / VMEG13 (contains 20 units)	7910986



VIP-SAFETY ELEMENTS AUTOMATIC HOOK

Subject to technical changes!

- Spare part set for VIP-Automatic clevis connection hooks consisting of:
 - 1 locking lever
 - 1 spring
 - 2 clamping sleeves

Chains	Designation	Order no.
8	Spare part set for VAGH(S) 8	8503759
10	Spare part set for VAGH(S) 10	8503713
13	Spare part set for VAGH(S) 13 and VMAGH(S) 13	7998255
8	Assembly set without locking lever for VAGH(S) 8	7910416
10	Assembly set without locking lever for VAGH(S) 10	7910417
13	Assembly set without locking lever for VAGH(S) 13	7910418



ENDLESS CHAINS IDENTIFICATION TAG

Subject to technical changes!

- Grade-neutral identification tag for endless chains.

Designation	Order no.
Endless chains identification tag	7909698



TEST DATA TAG

Subject to technical changes!

- Test data tag for permanent marking of the test intervals according to DGUV rule 100-500 (BGR 500).

Designation	Order no.
Test data tag PDA	60228



Only use original VIP-Spare parts!

VIP-SAFETY ELEMENTS VVS

Subject to technical changes!

- Spare part set for VIP- and ICE-Connection links consisting of:
 - 1 bolt
 - 2 clamping sleeves

Chains	Designation	Order no.
6	RUD spare part set for IVS-6 and VVS-6	7903886
8	RUD spare part set for IVS-8 and VVS-8	7903887
10	RUD spare part set for IVS-10 and VVS-10	7903888
13	RUD spare part set for IVS-13 and VVS-13	7903889
16	RUD spare part set for IVS-16 and VVS-16	7903890



VIP-SAFETY ELEMENTS VMVK, VV AND VML

Subject to technical changes!

- Spare part set for VMVK consisting of:
 - 1 safety bolt
 - 1 pressure spring
 - 1 clamping sleeve (for assembly of the safety bolt)
 - 1 clamping sleeve, long (for chains lock in the slot)

Chains	Designation	[kg/pc.]	Order no.
4	Spare part set for ICE-/VIP-MINI-Lifter	0.05	7987159
6	Spare part set for VMVK 6	0.01	7995046
8	Spare part set for VMVK 8	0.02	7987081
10	Spare part set for VMVK 10	0.04	7987082
13	Spare part set for VMVK 13	0.07	7991182
16	Spare part set for VMVK 16	0.13	7991183
20/22	Spare part set for VV 20 / 22	0.39	7995921
28	Spare part set for VV 28	0.5	7902140



VIP-SPARE BOLTS WITH SAFETY CLAMPING SLEEVE

Subject to technical changes!

- VIP-Clevis connection bolts for connecting the clevis connection components to the chains. Stamped with the nominal size and grade, stainless safety clamping sleeve for assembly/securing in components.
- Only available as packing units.

Chains	Designation	Order no.
4	VG-4 / tensioning sleeve 4 ²	7985638
6	VG-6 / tensioning sleeve 6 ²	7985639
8	VG-8 / tensioning sleeve 8 ²	7985640
10	VG-10 / tensioning sleeve 10 ²	7985641
13	VG-13 / tensioning sleeve 13 ²	7985642
16	VG-16 / tensioning sleeve 16 ³	7985643
20	VG-20 / tensioning sleeve 20 ³	7985644
22	VG-22 / tensioning sleeve 22 ³	7985645
28	VG-28 / tensioning sleeve 28	7900708



² Only available as a packing unit with 10 units.

³ Only available as a packing unit with 4 units.

EDGE PROTECTION RSK

Subject to technical changes!

- RUD RSK system made of hard-wearing edge-resistant polyurethane.
- Flexible in all directions. Can be moved manually on the chains. Even load distribution by diagonal chains crossover. Available in lengths 1 m and 2 m.

Chains	Designation	A	B	Order no. (1 m)	Order no. (2 m)
6	RSK-6	27	27	7911093	56 033
8	RSK-8	33	33	7911095	56 037
10	RSK-10	38	38	7911096	55 810
13	RSK-13	50	50	7911097	56 038





KNOWLEDGE AND SERVICE.



THE RUD IDENTIFICATION TAGS.

Multifunctional with added value: Information, documentation, chains gauge.



FRONT		BACK		
1. Wear occurrence test of the nominal thickness with details of the min.-Ø (-10% dm).		4. Inspecting chains division. Division increase by nominal thickness wear occurrence.	5. Number of suspension strands (multi-strand).	6. Nominal chains thickness Ø.
2. ICE-WLL (single strand).	3. Next test data embossed.	7. ICE-WLL with inclination angle details.	8. Inspecting plastic elongation due to overload.	9. Ident. no.

ICE-IDENTIFICATION TAGS.

Inspecting Ø wear occurrence.	Inspecting plastic elongation due to overload.	Inspecting the division extension by nominal thickness wear occurrence.

Always with you: The patented RUD identification tags with multi-function contribute to the safe use of your RUD chains. Informing you about the most important key figures and documenting the test data for the chains. Thanks to the integrated chain gauge, they can also be used to easily check diameter wear occurrence, division elongation and plastic elongation due to overload. This gives you continuous control over the three important discard criteria for your lifting and lashing chains.



FRONT		BACK		
1. Wear occurrence test of the nominal thickness with details of the min.-Ø (-10 % dm).		4. Next test data embossed.	5. Number of suspension strands (multi-strand).	6. Nominal chains thickness Ø.
2. VIP-WLL (single strand).	3. Inspecting of chains division enlargement due to nominal thickness wear occurrence.	7. Inspecting plastic elongation due to overload.	8. VIP-WLL with inclination angle details.	9. Ident. no.

VIP-IDENTIFICATION TAGS.

Inspecting Ø wear occurrence.	Inspecting plastic elongation due to overload.	Inspecting the division extension by nominal thickness wear occurrence.

RUD CONFIGURATION TOOLS: SOMETHING YOU CAN COUNT ON.

Our service for designers and users: With several configuration tools, we support you in the safe planning of lifting points and the correct configuration of lashing chains. Simply download our smartphone app for lashing equipment calculation free of charge from the App Store or Google Play Store. You can use our tools for lifting points, suspension and lashing chains calculation directly on our website at www.rud.com.

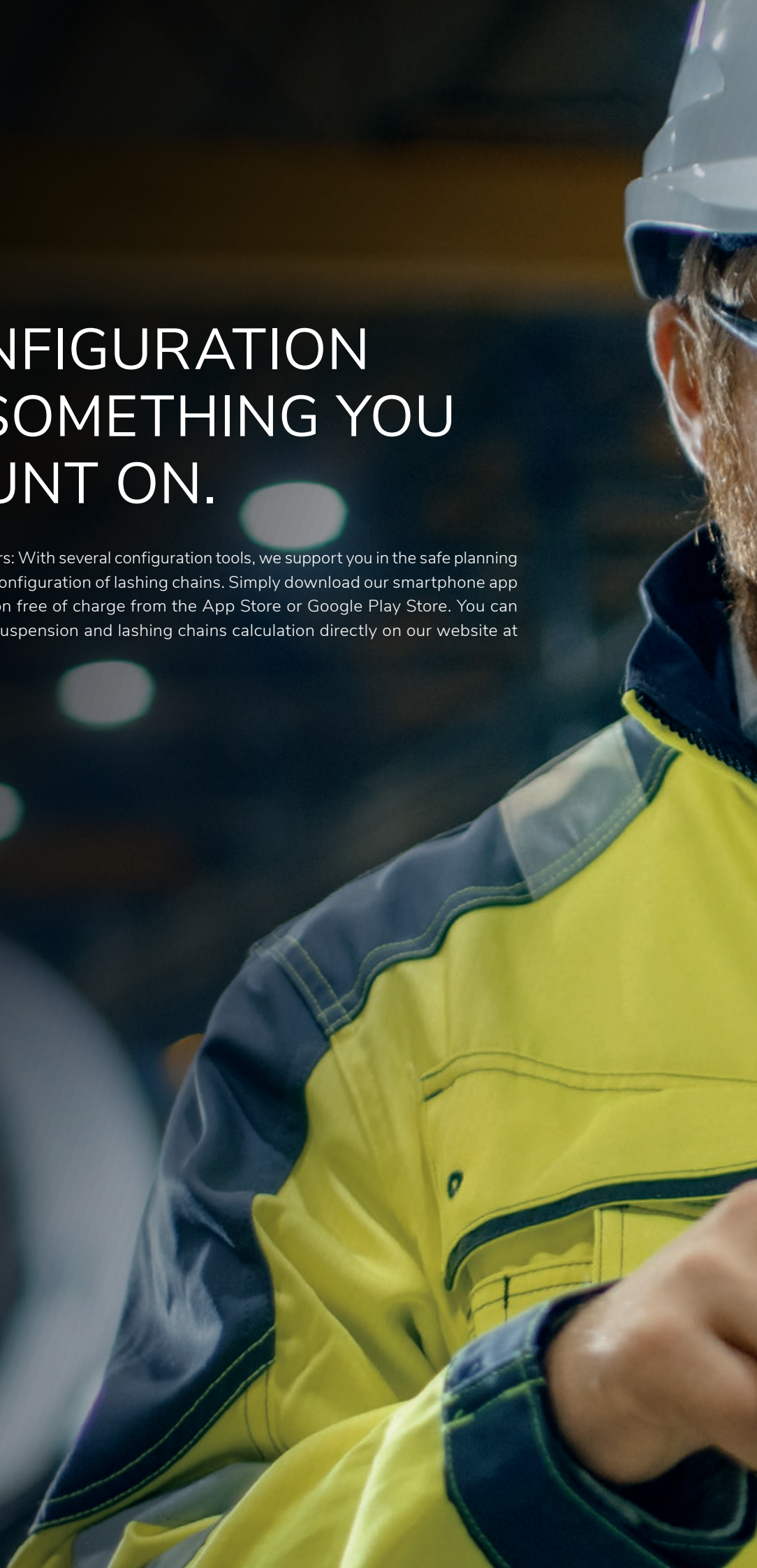



INSPECTING LIFTING MEANS.

What you should know about inspecting and what to consider.



VISUAL INSPECTION.

Visual inspections serve to detect external defects, e.g. bent chain links, twisted or notched chain links. In addition, the condition of the components and proper assembly as well as the completeness and effectiveness of the safety devices are checked.



Attention!

A surface treatment may only be done by the manufacturer. Pay attention to the temperature influences. VIP-Chains and VIP-Components must not be brought into contact with aggressive chemicals and acids!

Only use original RUD spare parts.

INSPECTING CHAIN SUSPENSIONS.

Chains suspensions must be checked by an expert at intervals of no more than one year. Depending on the operating conditions, tests may also be necessary at shorter intervals. After a maximum of three years, chains must be subjected to a special test for freedom from cracks (according to DIN 685-5). Chains must also be checked by an expert after special incidents which may affect the WLL.

Note on regular inspection:

The operator must determine and specify the type and scope of the required tests and the deadlines for in-service inspections by means of a risk assessment.



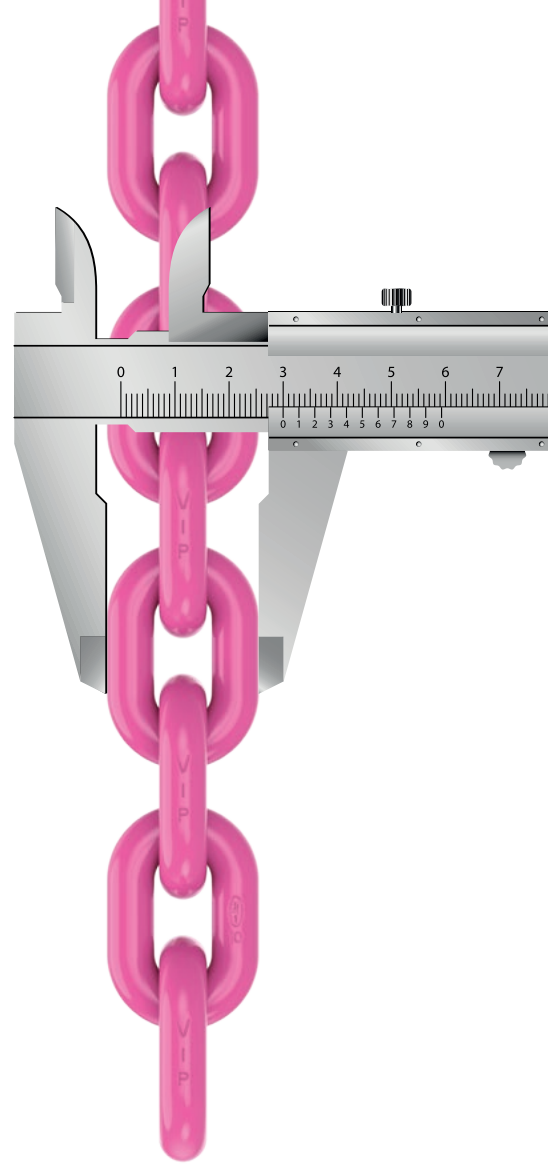

USE LIFTING CHAINS WITH A HIGHER WLL.

RUD components are designed according to DIN EN 818 and DIN EN 1677 for a dynamic load of 20,000 load cycles.

- Please note that several load cycles can occur during one lifting operation.
- Please note that due to the high dynamic load there is a risk that the product will be damaged if high load cycles are applied.
- The BG/DGUV recommends: In the case of high dynamic loads with a high number of load cycles (continuous operation), the load-bearing stress must be reduced according to mechanism group 1Bm (M3 according to DIN EN 818-7). Use lifting means with a higher WLL.

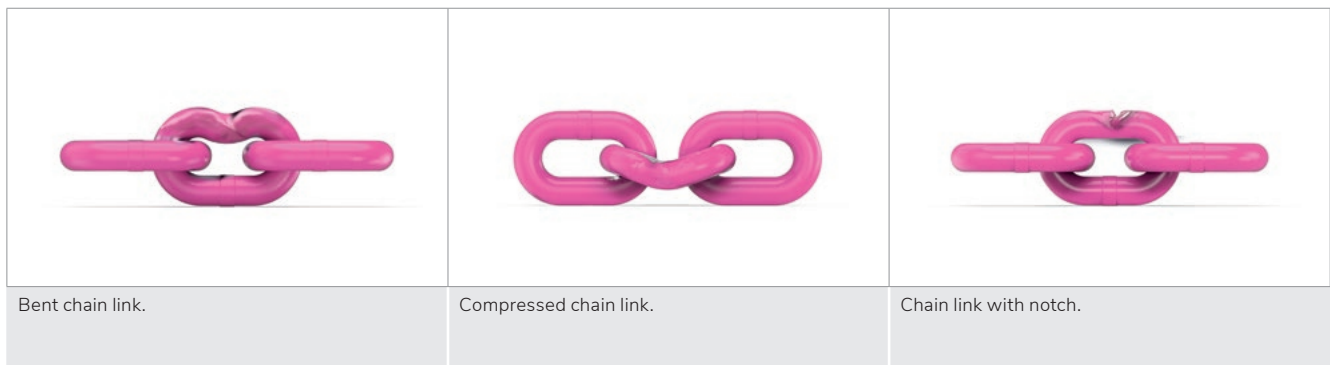



INSPECTING CHAINS.

To be inspected:

1. The diameter d_m ,
2. The plastic elongation due to overloading by more than 5 % based on the division of 3 d,
3. The division extension due to nominal thickness wear occurrence.

INSPECTING COMPONENTS.

Heavily loaded components must be inspected very critically.

Load hooks must be discarded if the jaw is widened by more than 10 % and if the bottom of the hook is worn by more than 5 % or has strong notches. Marking points dimension F. Also lateral bending on load hooks. Max. permissible wear occurrence of the VG bolt diameter $\leq 10\%$. When replacing accessories, always use new connecting bolts and locking elements (clamping sleeves)!





DOCUMENTATION IN A CHAINS FILE.

Entries in the chains file provide information on monitoring measures during use of lifting chains. For the user, this is urgently required to document compliance with occupational safety/accident prevention measures (EU Machinery Directive) to the trade supervisory authority/occupational health and safety association.

THE EFFICIENT SOLUTION: THE RUD BLUE-ID SYSTEM.

With the RUD BLUE-ID SYSTEM, RUD offers a convenient overall solution for lifting means. You can imagine how wireless transmission by RFID transponder and the RUD reader makes product identification very convenient. And the special software solution also makes documentation and administration extremely easy. This reduces the workload for the user in everyday use and saves costs. RFID transponders are fitted as standard in defined RUD products and can be retrofitted for many others.

RUD RFID
CONNECT IT 



OFFER WITH A SYSTEM.

IT MIGHT BE OF INTEREST TO YOU TOO.

As a system provider, we are happy to support you holistically. This is why you will find many other products at RUD, which are essential for the safe lifting, moving and transporting of loads. Detailed information on this is available in our special catalogues or at www.rud.com.



RUD LASHING EQUIPMENT.

RUD lashing equipment in quality class 12-ICE stand for fast attachment and extra safety when transporting loads. They enable high maximum lashing forces with comparatively small chain dimensions – i.e. high ergonomics through lower weight.



RUD LIFTING MEANS.

RUD lifting means in quality classes 12-ICE and 10-VIP are the first choice for lifting and moving. They not only offer high WLL with a smaller chains diameter, but also a maximum of user-friendliness through easier, power-saving handling.



RUD LIFTING POINTS.

The right one for every application: lifting points from RUD are available in countless weldable and screwable variants. Equipped with the powerful ICE-BOLT, they achieve higher WLL and unmatched high safety factors with smaller bolt diameters.



RUD ICE-MINI: THE PERFECT CHAINS FOR THE SMALLEST LOADS.

Lifting is not always about loads weighing tonnes. Our tip: The RUD ICE-MINI lifting chains are ideal for lighter weights. Its special feature is that it can be shortened in a flash with a push button.



RUD TOOL MOVER TURNING TOOL.

With the TOOL MOVER turning tool, tools weighing a ton and susceptible or injection moulds can be turned safely, ergonomically and in a time-saving manner. With the large choice of attachment parts, you not only protect the tools, but also your employees.



RUD SEMINARS.

Stay on the ball: As a participant in our seminars and training courses, you will always be up-to-date on topics, such as safety, materials and legal regulations.



RUD EXPERT DIALOGUE.

Do you have questions, special problems or complex lifting and transport tasks? Send us an e-mail to slings@rud.com or call us on: +49 7361 504-1370.

GLOSSARY.

A

Avoiding configuration errors 15

B

BLUE-ID SYSTEM 28–29

C

Calculations 14–15

Centre of gravity of the load 14–15

Coating types 22

Component selection 16–17

Configurators 120

Connection to the crane hook 42–45, 76–81

Construction kit 23

Container components 55, 57, 104–107

Cross beams 96–97

D

Design 12

Designation 118–119

Documentation review 125

E

Endless chains 91

G

Grade comparison 20–21

H

Heat indicator 22

Hooks 53–57, 98–102

I

ICE-Component selection 38–39

ICE-Construction kit 35–37

ICE-Grade 24

Insulation 87

M

Material properties 18–21

N

Non-mix-up assembly 23

O

Operating equipment testing 28–29

Overload control 95

R

Repair 62–63, 114–115

RFID 28–29

Rotating and turning 94

S

Safety factor 12

Shackles 88–89

Shortening 47, 49, 52, 84–86

Special applications – large/maximum loads 108–111

Special applications – small loads 60–61, 112–113

Suspension configuration 12–15

T

Temperature resistance 22

Testing accessories 124

Testing chains suspensions 122

Testing components 124

Transponder 28–29

Twisted chains 83

V

VIP-Component selection 72–73

VIP-Construction kit 66–71

VIP-Grade 26

W

Welding when lifting 87

WLL increase 50–51, 92–93

WLL table 32–33

AT HOME INTERNATIONALLY.

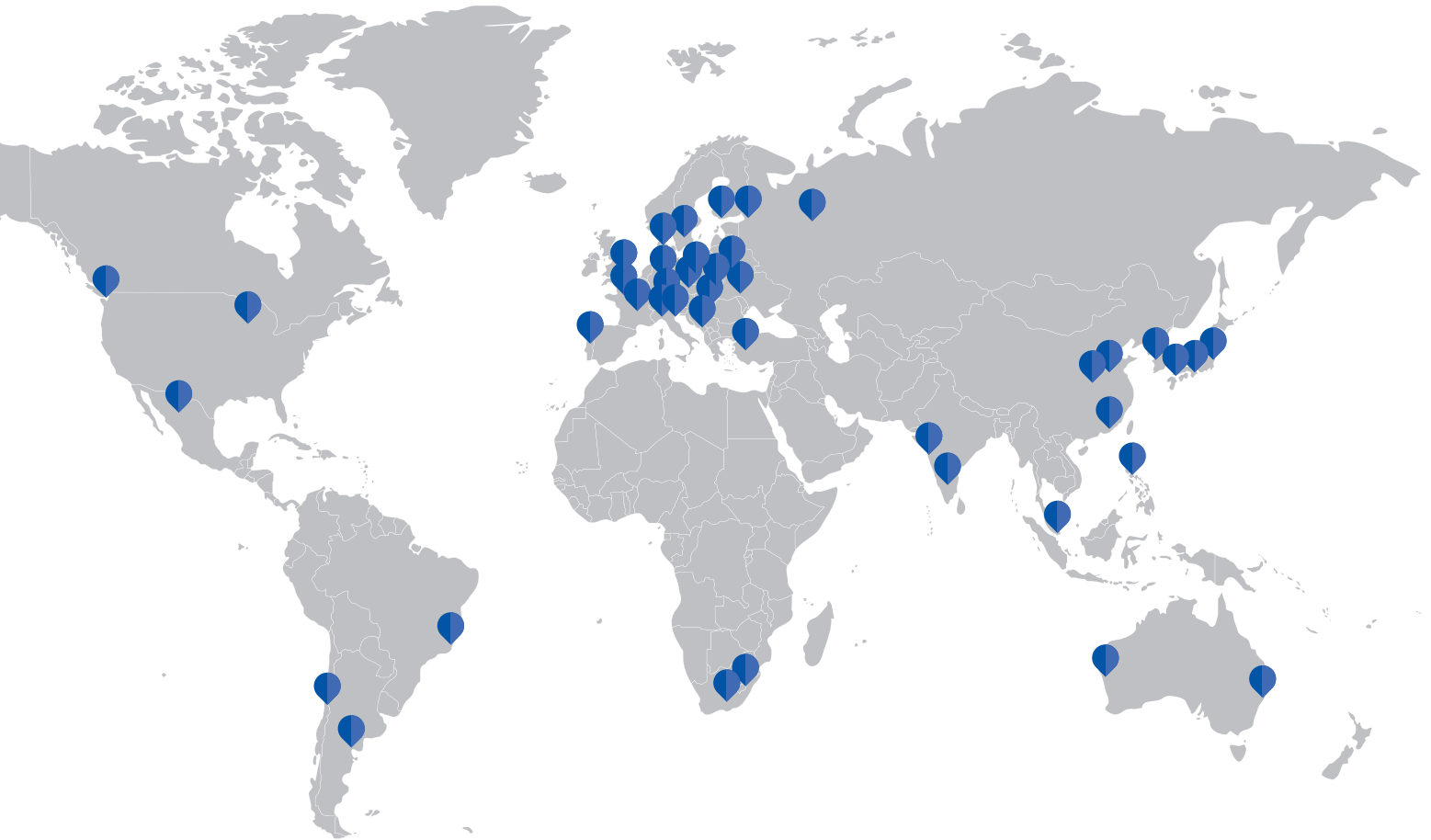

Users all over the world appreciate our innovative strength and our intelligent solutions for lifting, moving and securing loads. To be as close as possible to our customers, we are constantly expanding our worldwide sales and service network. Our large number of RUD subsidiaries, affiliated companies and specialist trade partners ensure that our consulting expertise and our products are available worldwide.



RUD Ketten
Rieger & Dietz GmbH u. Co. KG

Friedensinsel
73432 Aalen, Germany

Phone: +49 7361 504-1370
Fax: +49 7361 504-1171

Mail: sling@rud.com
Web: slingandlashing.rud.com
www.rud.com