

02

EXOSET® SAFETY LIFTING CLAMPS

Height Safety
Lifting
Load Control
Safety Management

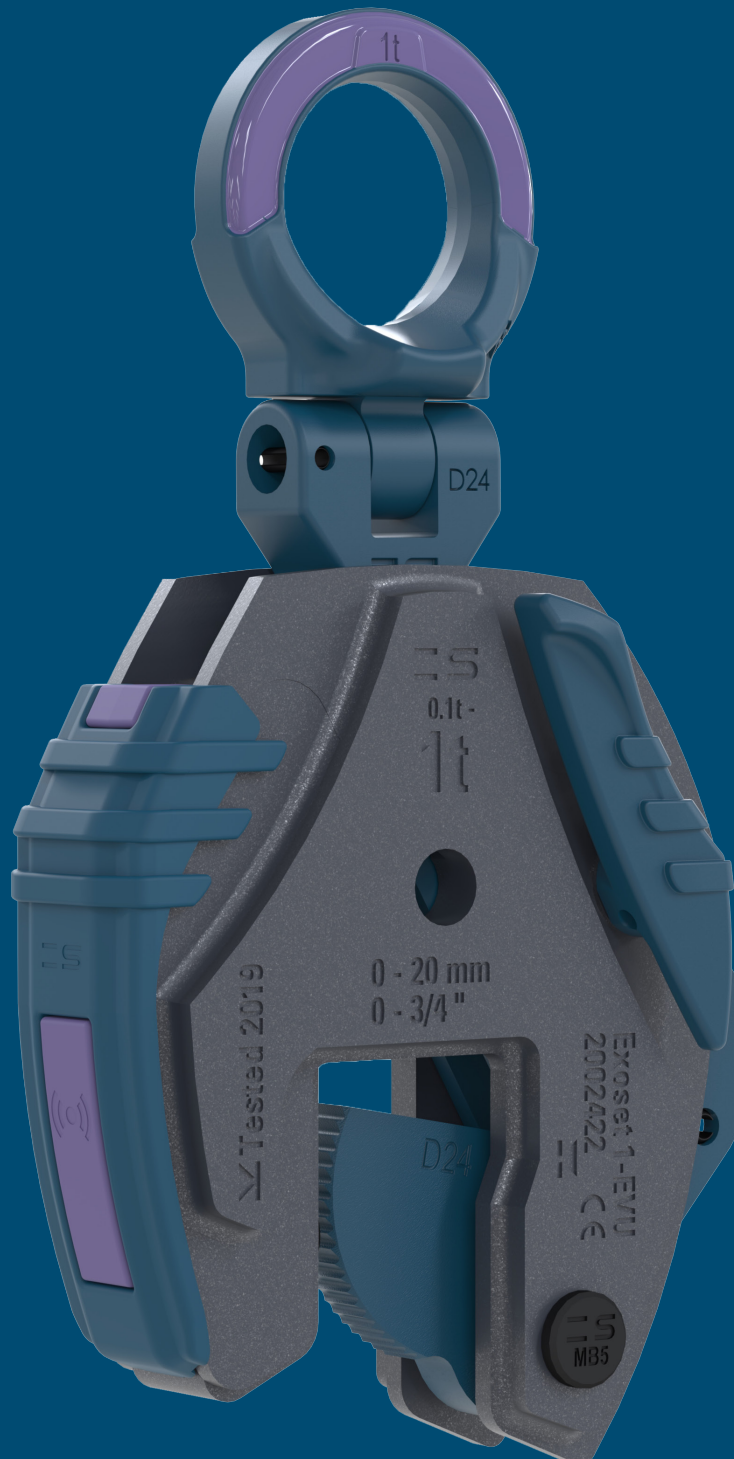

SpanSet worldwide - Reliability since 1966

You can always rely on SpanSet. Our practical solutions for height safety, lifting technology and load control are individually manufactured for you according to ISO-certified procedures. They stand for the highest quality and working efficiency.

SpanSet also supports you before and after purchase: with services, inspections, and a comprehensive training programme as well as personal advice for your practical requirements. And, you can rely on that.

We are Accountable

Safety is our top priority when it comes to protecting human lives, lifting heavy loads, or transporting goods. We offer well-known, quality products and innovations in the fields of height safety, lifting technology and load control.

Please visit us on our homepage

At www.spanset.com you will discover interesting information about our company, new products, trade fair dates, services and our distribution network of specialist dealers throughout Switzerland. Simply photograph the QR code with your mobile phone's QR reader.

SpanSet
Certified
Safety

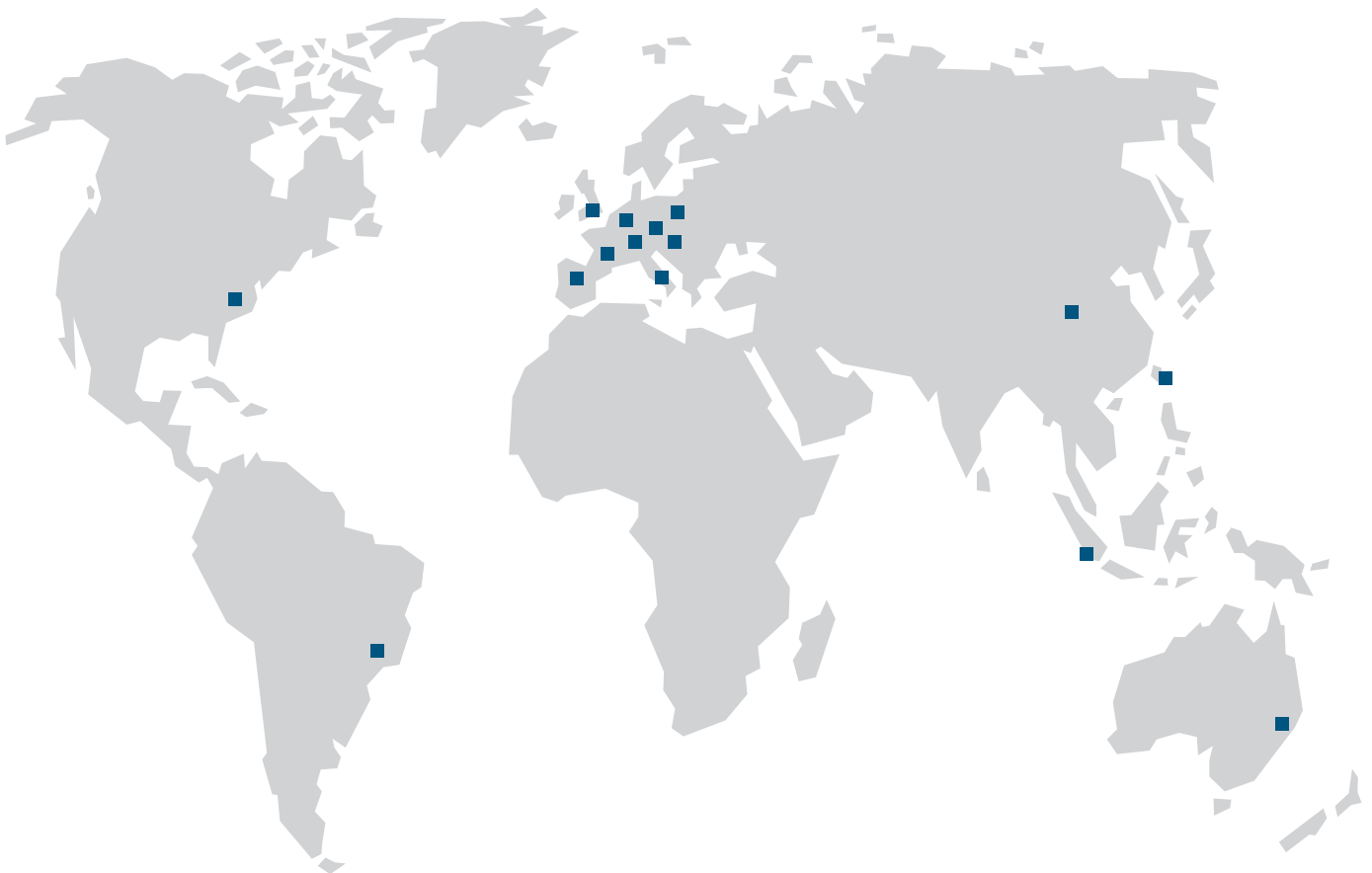

SpanSet worldwide:

Switzerland, Germany, England, Spain, France, Italy,
Austria, Hungary, Netherlands, Poland, Australia,
Brazil, USA, Indonesia, Taiwan, China





APPROVED

DNV Type Approval:
Exoset safety lifting clamps are the only lifting clamps in the world with a type approval by DNV.

EXOSET UNIVERSAL VERTICAL SAFETY LIFTING CLAMPS

SpanSet, the market leader in webbing based products, once again confirms its innovative power with the introduction of a series of universal vertical safety lifting clamps.

In many ways, Exoset safety lifting clamps offer improvements when compared to the lifting clamps currently available. When we started developing Exoset safety lifting clamps, our main tasks were to improve safety on the shop floor and the clamp's ergonomics. We have achieved both goals in designing the Exoset clamps; an effort that has been recognised in the award of a DNV certificate. Exoset safety lifting clamps are the only lifting clamps in the world certified by DNV.

Improved safety

We added a maximum WLL indicator, located where it is clearly visible on the hoisting eye and the grip. This Indicator makes it easy for the user to recognize the maximum load for which the lifting clamp can be used. Additionally we improved safety by adding an overload indicator as well as a corrosion resistant layer. There is also an option for a wear indicator. These innovations improve safety on the shop floor!

Easier handling

We have constructed a series of very robust, lightweight clamps. This is possible using welded bodies and the highest quality Naxtra steel. The grip has been specially designed to give the user a better hold on the clamp while attaching it to the plate. We improved and enlarged the latch design for easier opening and closing. These innovations improve the ergonomics of our Exoset safety lifting clamps.

Vertical transport of plates - universal











Exoset universal vertical safety lifting clamps are suitable for the lifting, turning (180°), moving and vertical transfer of sheet materials, plates and fabrications. Plates can also be turned from horizontal to vertical and back down to horizontal (180°).

All Exoset universal vertical safety lifting clamps are fitted with a locking device for both open- and closed positions, which ensures complete safety. The universal hoisting eye allows the clamp to place and lift the load from any direction, or with a multiple leg sling without side-loading the clamp.

Exoset hoisting eye shaft

The Exoset hoisting eye shaft has two flat sides, due to this construction the friction is better distributed and indents in the body can be avoided. This construction distributes the force more evenly, reduces wear and extends the service life of the Exoset safety lifting clamp.

Nominal carrying capacity WLL [kg]

	500 kg		5.000 kg
	1.000 kg		6.000 kg
	2.000 kg		8.000 kg
	3.000 kg		10.000 kg
	4.000 kg		>10.000 kg

Exoset safety lifting clamps are the only lifting clamps in the world certified by DNV.

- DNV Type Approval – ST – 0378
- European Norm EN 13155
- USA Norm ASME B30.20, Design category C, Service class 4
- USA Norm ASME BTH – 1
- Australian Norm 4991
-  European Machine Directive 2006/42/EC.

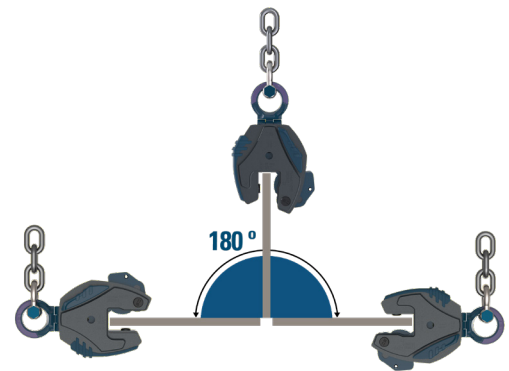

0.5t



1t



2t

USP

MADE IN
EUROPE



Maximum WLL indicator

Optimised hoisting eye shape

Improved, larger latch design

For easier opening and closing

Grip for easier handling

Improved corrosion resistance

Parts are powder coated

Maximum WLL indicator

Welded alloy body

Very robust,
lightweight body

Equipped with RFID chip

Overload indicator
for body

Improved safety

Optional:
Wear indicator on camsegment
and pivot

Special coloured hardening on
camsegment and pivot

Alloy steel shafts with
anti-corrosion coating
and traceability code

All load-bearing parts are
marked with a batch code



3t



5t



6t

UNIVERSAL VERTICAL LIFTING CLAMPS – FOR LIFTING IN ANY DIRECTION

- Available in capacities 0.5t-6t. Higher WLL and different jaw apertures are available upon request.
- Lock open, lock closed ability with latch for pre-tension on load and then release of load.
- Breaking Load Limit of 6x WLL
- Load cycles until Exoset universal vertical safety lifting clamps are unusable (tested in vertical position); 2.000.000 load cycles.
- For use with materials with a surface hardness up to 364 HV, tensile strength 1200 N/mm².
- Minimum WLL needed is 10% of maximum WLL
- Temperature range -40°C/104°F - +100°C/212°F.
- Each clamp is individually serialized. Serial number and date of Proof Load test are permanently marked on the body.
- All load-bearing parts are marked with a traceability code and the SpanSet logo to guarantee the original, highest-quality SpanSet parts.
- Individually Proof Tested to 2x the Working Load Limit with certification.
- Instruction manual and test certificate included with each clamp.
- Service and repair manual available through SpanSet website.
- Maintenance and overhaul kits for all clamps are available. All Exoset safety lifting clamps are RFID equipped.
- Exoset safety lifting clamps are the only safety lifting clamps in the world certified by DNV.
- EVU H for vertical lifting, transporting and turning of all steel plates with a maximum hardness of 473 HV, tensile strength 1550 N/mm² (for example Hardox 400 and 500).
- EVU S for vertical lifting, transporting and turning for stainless steel plates. With a maximum hardness of 364 HV, tensile strength 1200 N/mm².
- 5 Year Warranty (see conditions on www.Spanset.com)
- See other Exoset products for connection between clamp and the hoist hook.

Specification table (Metric)

Model	WLL (t)	Order number	Jaw aperture (mm)	Dimensions (mm)										Product weight (kg)	
				A	B	C	D	E	F	G	H	I	J		
0,5-EVU	0,5	2002421	0-16	39	226	134	40	41	22	114	13	20	28	1.9	
1-EVU	1	2002422	0-20	39	237	145	52	44	28	127	13	20	28	2.1	
2-EVU	2	2002423	0-35	68	375	209	76	61	48	192	18	32	44	7.6	
3-EVU	3	2002424	0-40	73	446	262	101	71	55	299	22	42	58	14.8	
5-EVU	5	2002425	0-40	73	446	262	101	71	55	299	22	42	62	16.0	
6-EVU	6	2002426	0-50	80	549	327	131	97	59	284	37	42	62	24.0	
For very hard materials - with universal hoisting eye															
0,5-EVU H	0,5	2012561	0-16	39	226	134	40	41	22	114	13	20	28	1.9	
1-EVU H	1	2012562	0-20	39	237	145	52	44	28	127	13	20	28	2.1	
2-EVU H	2	2012563	0-35	68	375	209	76	61	48	192	18	32	44	7.6	
3-EVU H	3	2012564	0-40	73	446	262	101	71	52	299	22	42	58	14.8	
5-EVU H	5	2012565	0-40	73	446	262	101	71	52	299	22	42	62	16.0	
6-EVU H	6	2012566	0-50	80	549	327	131	97	59	284	37	42	62	24.0	
For stainless steel - with universal hoisting eye															
0,5-EVU S	0,5	2012567	0-16	39	226	134	40	41	22	114	13	20	28	1.9	
1-EVU S	1	2012568	0-20	39	237	145	52	44	28	127	13	20	28	2.1	
2-EVU S	2	2012569	0-35	68	375	209	76	61	48	192	18	32	44	7.6	
3-EVU S	3	2012570	0-40	73	446	262	101	71	52	299	22	42	58	14.8	
5-EVU S	5	2012571	0-40	73	446	262	101	71	52	299	22	42	62	16.0	
6-EVU S	6	2012572	0-50	80	549	327	131	97	59	284	37	42	62	24.0	



Hard materials



Stainless steel



Long life and wear indicator

TECHNICAL SPECIFICATIONS

Dimensions

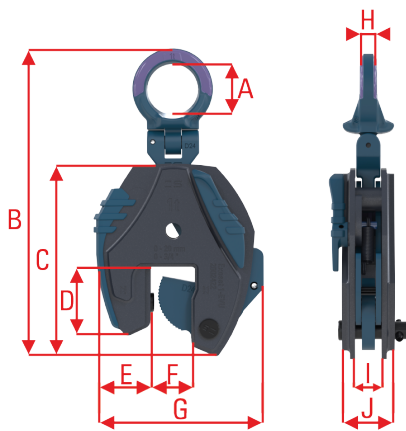

Load angles diagram

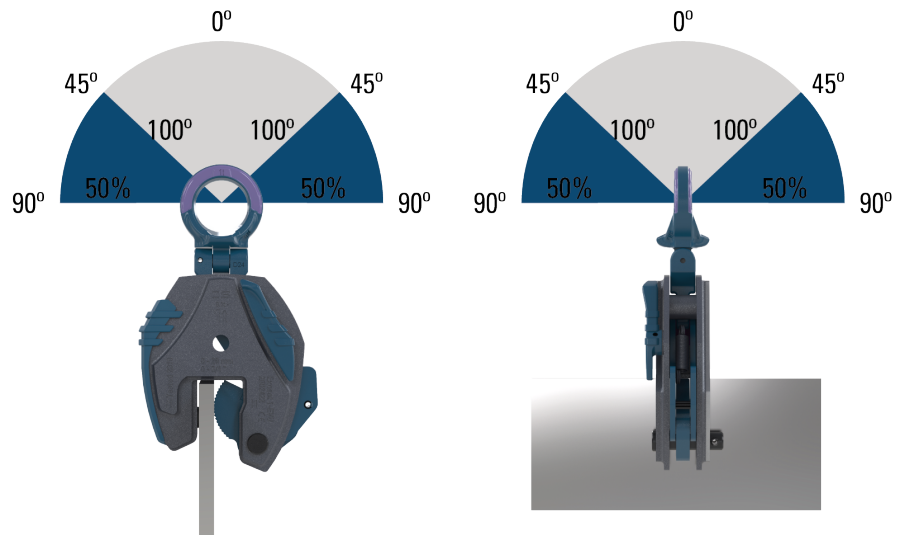

IDXpert Net provides you with a robust asset management and tracking system

- Utilises the latest RFID technology to automate the routine inspection process for your equipment.
- Allows online access to your certificates and inspection records wherever you are connected to a secure web portal.
- Uniquely identifies all items of equipment with RFID tags to reduce inspection times.
- Provides a facility audit via a hand held device to check the inspection status of equipment.

Examples of Equipment that can benefit from IDXpert Net management

- Exoset safety lifting clamps
- Working at height personal protective equipment
- Fall arrest blocks
- Working at height hardware and connectors
- Synthetic lifting slings
- Chain slings and wire ropes
- Hoists, shackles and lifting accessories
- Cranes
- Fork lift trucks



Most SpanSet products are equipped with IDXpert transponders, for example Exoset safety clamps and lifting slings. Other products can also be retrofitted with an IDXpert transponder. There are different tag options for different applications. For more information, see www.spanset.com.

Traceability

The body and all load-bearing parts of an Exoset safety lifting clamp are permanently marked with SpanSet short logo, serial number, batch code, test date and/or year of manufacture. Identification points such as clamp type, load capacity, jaw width (in mm and inches) are firmly stamped on the body of an Exoset safety lifting clamp.



Camsegment shaft





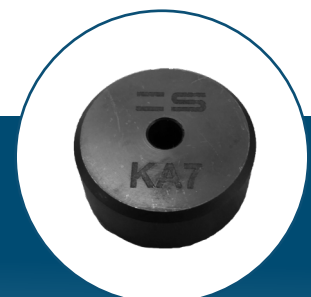















Hoisting eye shaft



Pivot

EXOSET VERTICAL SAFETY LIFTING CLAMPS - FOR LIFTING IN ANY DIRECTION

Ordering numbers

Model	WLL (t)	Order number clamp	Order number Maintenance kit	Order number Overhaul kit	Order number grip	Order number hoisting eye
 0,5-EVU	0,5	2002421	2011063	2011069	2011075	2012526
 1-EVU	1	2002422	2011064	2011070	2011076	2012525
 2-EVU	2	2002423	2011065	2011071	2011077	2012527
 3-EVU	3	2002424	2011066	2011072	2011078	2012528
 5-EVU	5	2002425	2011067	2011073	2011079	2012529
 6-EVU	6	2002426	2011068	2011074	2011080	2012530
For very hard materials - with universal hoisting eye						
 0,5-EVU H	0,5	2012561	2016902	2016915	2011075	2012526
 1-EVU H	1	2012562	2016903	2016916	2011076	2012525
 2-EVU H	2	2012563	2016904	2016917	2011077	2012527
 3-EVU H	3	2012564	2016905	2016918	2011078	2012528
 5-EVU H	5	2012565	2016906	2016919	2011079	2012529
 6-EVU H	6	2012566	2016907	2016920	2011080	2012530
For stainless steel - with universal hoisting eye						
 0,5-EVU S	0,5	2012567	2016908	2016921	2011075	2012526
 1-EVU S	1	2012568	2016909	2016922	2011076	2012525
 2-EVU S	2	2012569	2016910	2016923	2011077	2012527
 3-EVU S	3	2012570	2016911	2016924	2011078	2012528
 5-EVU S	5	2012571	2016912	2016925	2011079	2012529
 6-EVU S	6	2012572	2016913	2016926	2011080	2012530

Maintenance kit



Overhaul kit



Optimum availability of spare parts and kits

The modular design of an Exoset Safety Lifting Clamp allows a quick and accurate inspection of the Exoset clamp as well as cost-effective parts replacement. Maintenance- and overhaul kits are available for all Exoset clamps.



Exoset shackle



Sling Joker hook



SpanSet Sling

EXOSET VERTICAL SAFETY LIFTING CLAMPS - FOR LIFTING IN ANY DIRECTION



Descr.	Body complete	Hoisting eye complete	Camsegment complete	Latch complete	Spring for latch complete	Camsegment shaft complete	Hoisting eye shaft	Pivot complete	Grip complete
Part no.	1000	2000	3000	4000	5000	6000	7000	8000	9000

Service and repair

There is a Service and Repair manual available for every Exoset Safety Lifting clamp. The manual provides clear instructions about how to inspect, maintain and test Exoset clamps. With the use of illustrations we explain how to assemble and disassemble Exoset clamps. We provide a table with the allowed tolerances for all parts and instructions regarding when to replace a part.



Instruction Manual



Service and Repair manual



IDX4U

DO'S AND DON'TS!

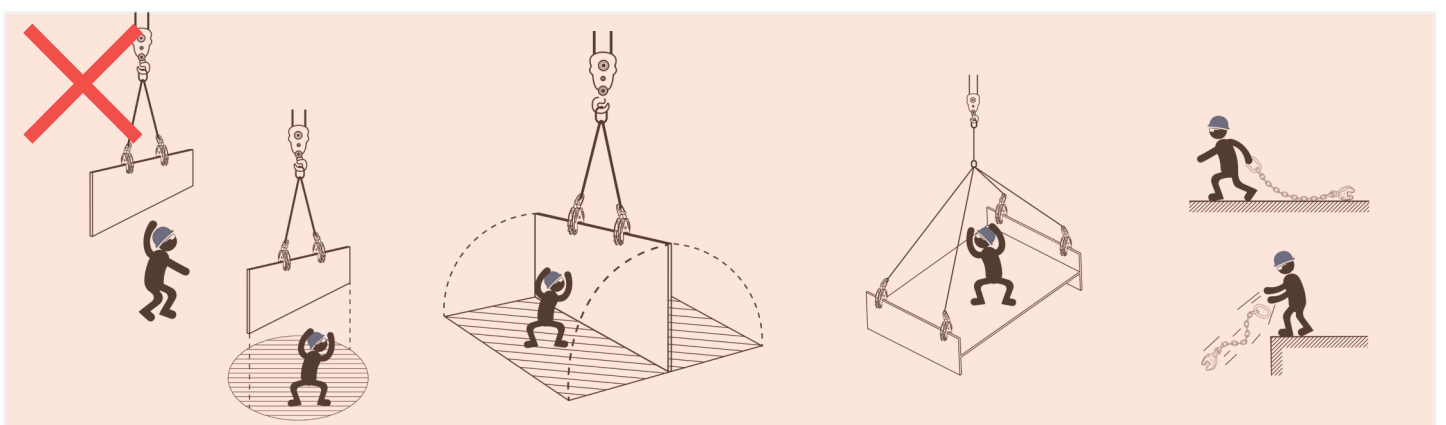
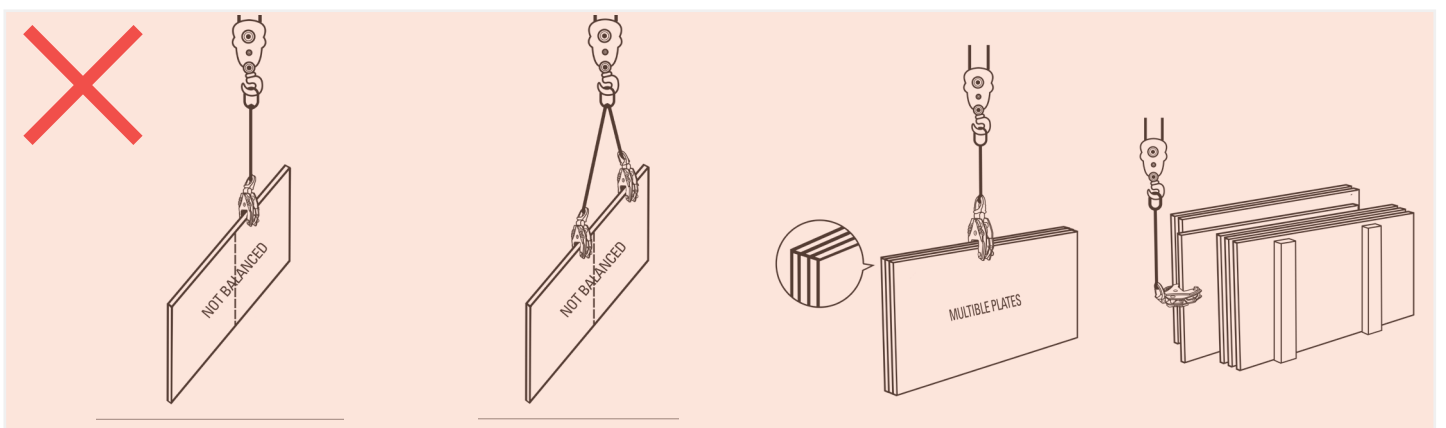
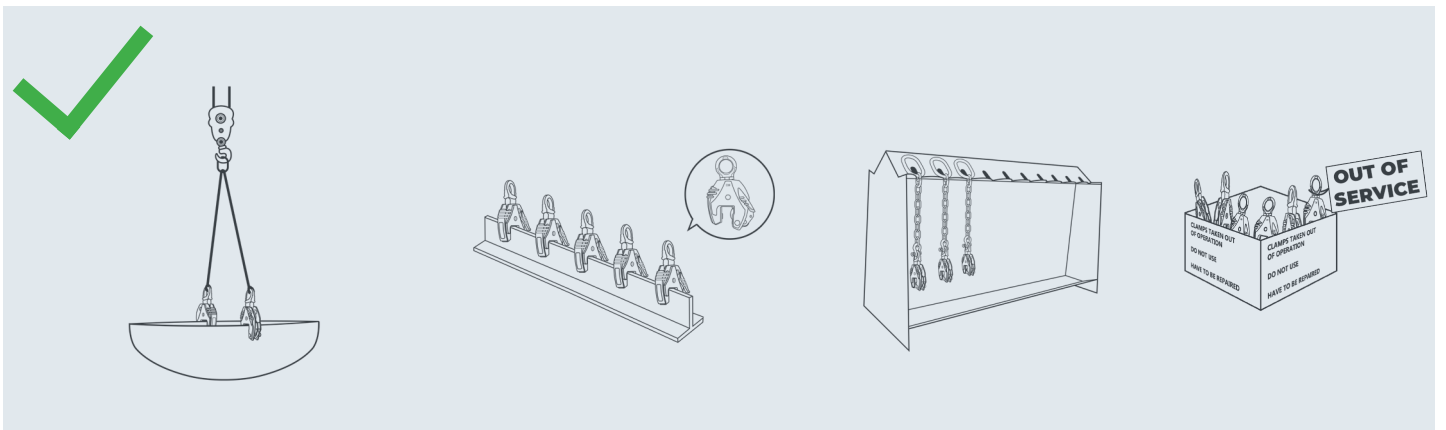
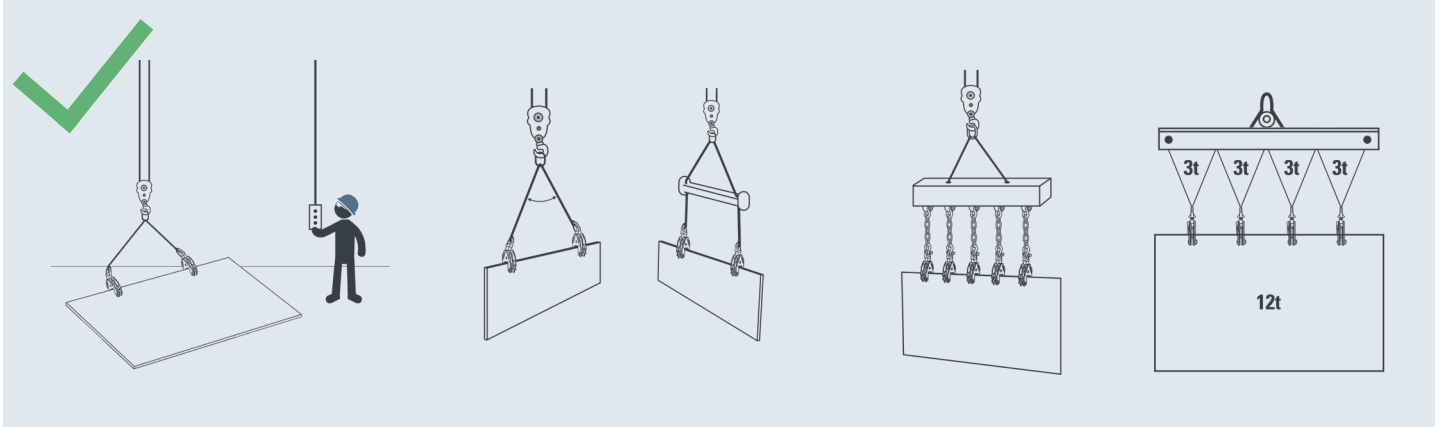

TRAINING PROGRAMS

Sales Training:

Target group:	Sales & Service engineers, Distributors
Objective:	General introduction to SpanSet followed by an extensive product training on how to use the clamps and areas of application
Training:	Presentation explaining the clamps using practical examples and questions
Duration:	90-120 minutes, max. of 10 people per session
Trainer:	SpanSet certified trainer
Location:	SpanSet office, onsite or at distributor's office

User Training:

Target group:	Shop floor workers and safety employees
Objective:	Working safely with lifting clamps. Using the right clamp, in the right way, at the right place
Training:	Presentation explaining the clamps using practical examples and questions
Duration:	90-120 minutes, max. of 15 people per session
Trainer:	SpanSet certified trainer
Location:	Onsite at customer's premises

Repair Training:

Target group:	Service engineers or SpanSet authorised dealers
Objective:	Obtain qualification as SpanSet certified repair station
Training:	Inspection, disassembling and assembling clamps Inspecting tolerances by using the SpanSet repair manual test of total procedure: inspection, disassembling, assembling and testing General applications of Exoset safety lifting clamps
Duration:	Full day training: 8:30-16:30 Maximum of 3 people per training
Trainer:	SpanSet certified trainer
Location:	SpanSet World-wide

CERTIFICATES

SALES TRAINING EXOSET SAFETY LIFTING CLAMPS

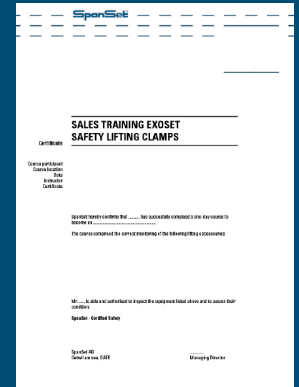

USER TRAINING EXOSET SAFETY LIFTING CLAMPS

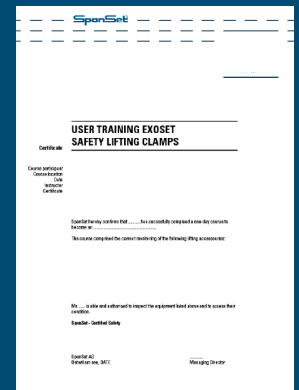

REPAIR TRAINING EXOSET SAFETY LIFTING CLAMPS

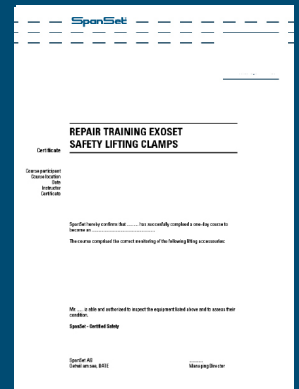

AUTHORISED DEALER SAFETY LIFTING CLAMPS

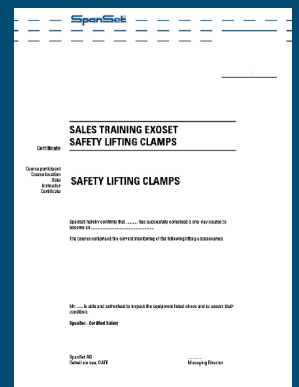

SpanSet International Services AG

Samstagernstrasse 45,
CH-8832 Wollerau
Phone +41 (0)44 929 70 70
Fax +41 (0)44 929 70 71
info@spanset.com
www.spanset.com

More from SpanSet

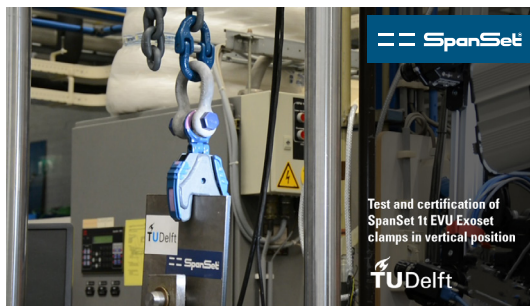
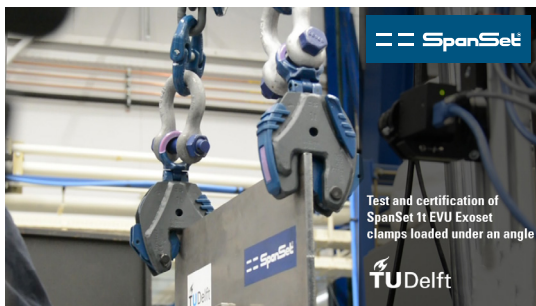

Watch the clamp testing videos on www.spanset.com

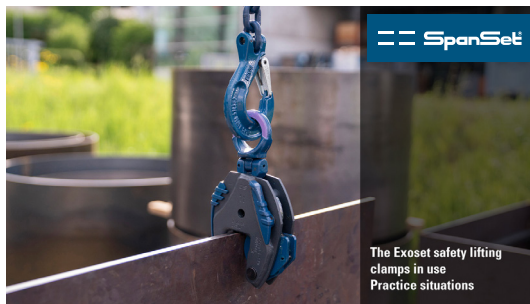
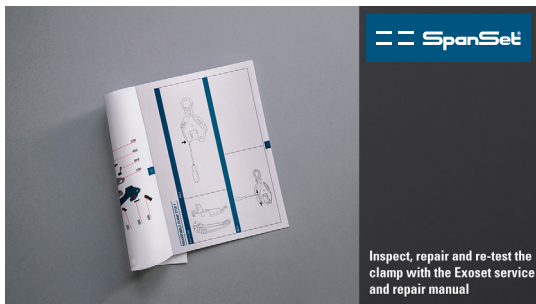

Watch the videos of clamp repair and practice situations on www.spanset.com



www.spanset.com

SpanSet certified safety

Subject to technical changes without notice. All rights reserved. No part of this catalogue may be reproduced in any form (by printing, photocopying, microfilm or any other method) or processed, copied or distributed by electronic methods without the written permission of SpanSet®. This catalogue has been created with all due attention to detail; SpanSet® accepts no liability for any errors or omissions.

Misprints, errors and modifications excepted!

All prices excl. VAT, ex works.