

LIFTING POINTS.

Main catalogue version 2 | English

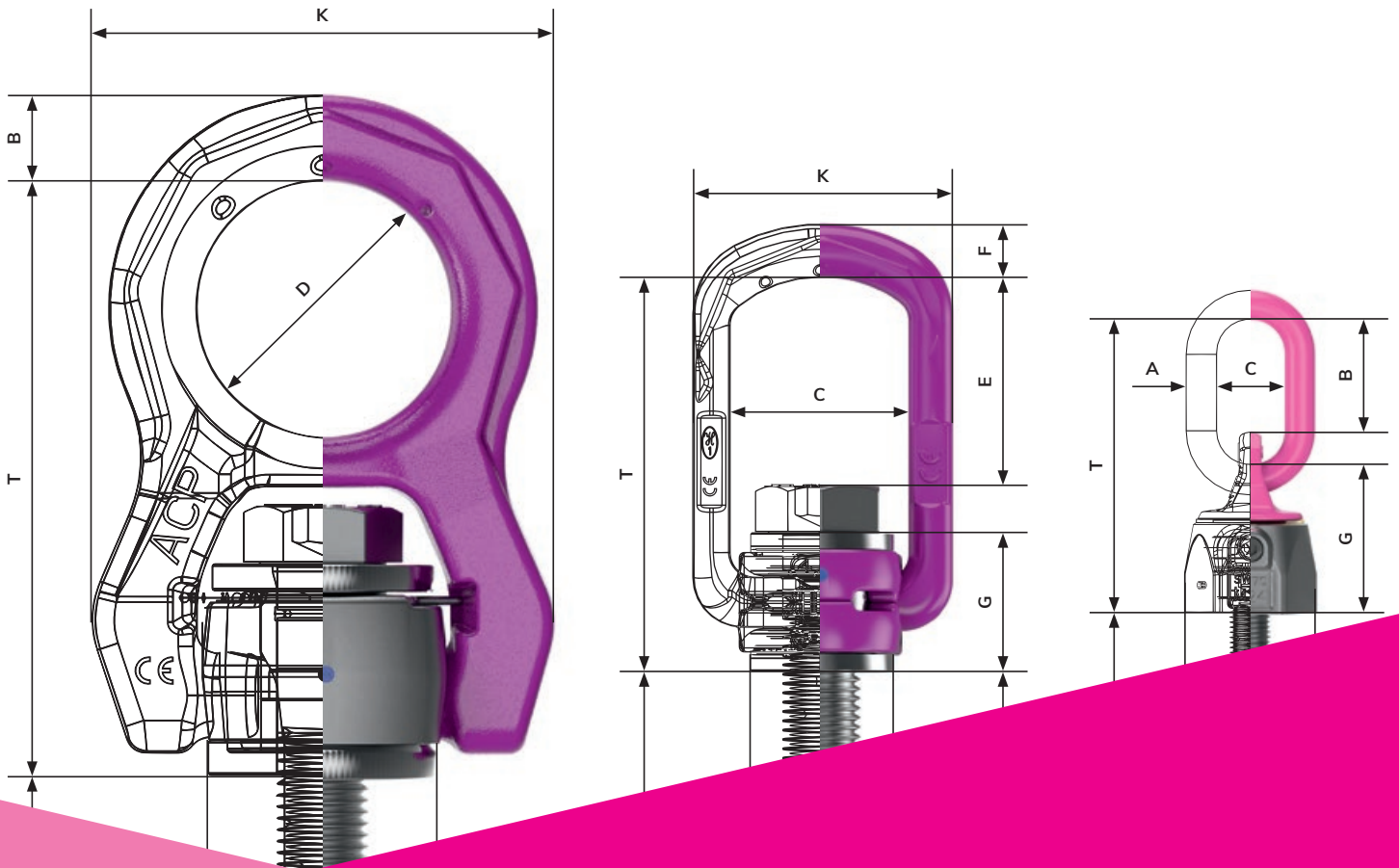



The background of the entire page is a blurred industrial setting. In the foreground, there are large, curved metal components, possibly parts of a crane or lifting equipment, with a metallic sheen. In the background, there are yellow overhead cranes and various industrial structures, suggesting a factory or workshop environment. The lighting is bright, highlighting the metallic surfaces.

WELCOME TO THE WORLD OF RUD.

MORE THAN PRODUCTS: YOUR PARTNER FOR SOLUTIONS.

From mould making and automotive industry to the offshore sector: RUD products stand for innovation, quality, ergonomics and safety. As a dynamic, globally active company, we develop chain systems and components for a variety of applications. And all this for 145 years. Furthermore, we have 40 years of experience in lifting technology and load securing – with 700 different attachment point variants meeting the highest requirements.

At RUD, however, you get much more than just products. Our aim is to always offer you the perfect solution to meet your specific requirements. We also support you with well-planned consultancy and services to make your projects a success.

Welcome to RUD.

CONTENT.

Lifting points main catalogue.

OUR CLAIM	6-7	OVERVIEW TABLE OF WELDABLE LIFTING POINTS	100-101
EFFICIENCY AND SAFETY	8-9	VLBS / VLBS-U / VLBS-U-LT / VLBS-P	102-105
RUD MILESTONES	10-11	VRBS-FIX / VRL-FIX / VASK-FIX	106-107
PRACTICAL KNOWLEDGE: LIFTING POINTS VARIETY.	12-13	VRBS / VRL / VASK	108-109
WHAT TYPES ARE AVAILABLE?	14-15	VRBK-FIX / VRL-FIX / VASKK-FIX	110-111
RISK ANALYSIS	16	W-ABA	112-113
ROTATING AND TURNING LOADS	18-19	VABH-W / VCGH-S	114-115
WHICH LIFTING POINT FOR WHICH CONSTRUCTION?	20	WPP(H)-S / -B / -VIP / -KA	116-117, 119
BOLTABLE LIFTING POINTS	21-26	VWBS / VWBS-KA	118
WELDABLE LIFTING POINTS	27-29	RUD CONFIGURATION TOOLS	120-121
INSTALLATION OF LIFTING POINTS	30-31	TESTING LIFTING POINTS	122-123
THE BOLT: ICE-BOLT	32-33	CROSS-SELLING: OFFER WITH A SYSTEM	124-125
RFID TECHNOLOGY	34-35	GLOSSARY	126
WLL BOLTABLE LIFTING POINTS	36-38	GLOBAL SALES AND SERVICE NETWORK	127
WLL WELDABLE LIFTING POINTS	39		
OVERVIEW TABLE OF BOLTABLE LIFTING POINTS	40-43		
ACP-TURNADO	44-49		
VLBG-PLUS / VLBG / VLBG-Z	50-53		
PP-S / PP-B / PP-VIP / VCÖH	54-57		
SO-PP-VIP / VWBG-KA / SO-PP-VIP-UNC	58-59		
TXP-TEXOLUTION-POINT	60-61		
VWBG-V / VWBG	62-67		
WBPG	68-69		
VRS-STARPOINT	70-75		
VRM-STARPOINT	76		
INOX-STAR	77		
VWBM	78-79		
RS / RM	80-85		
VABH-B	86-87		
VCGH-G	88-89		
B-ABA	90-91		
RBG / VRBG / VRBG-FIX	92-95		
T-FRB / B-FRB	96-97		
PSA-INOX-STAR / PSA-VRS	98-99		



OUR CLAIM: MAXIMUM QUALITY, BEST CUSTOMER ORIENTATION.

Innovation, perfection and the motivation to achieve added value for our customers: That is RUD's passion. Being a technological think tank, we repeatedly set standards for load securing and lifting technologies with our lifting and lashing equipment.

Our chain production facilities are among the most modern of their kind. Highly qualified specialists work here, who are never satisfied with the status quo. Because our thinking is focused on meeting customer needs and maximum benefit for the user. The long-term partnership with our customers, their satisfaction and their trust are our focus.

RUD. MADE IN GERMANY.

All RUD products around lifting and moving of loads have something important in common: They are developed and manufactured by us in Germany. In R&D alliances with research institutes, universities, suppliers and customers. With plenty of know-how, high creativity and state-of-the-art technology. This results in products and solutions of outstanding material quality, high robustness and exemplary ergonomics. In a nutshell: Quality made in Germany – made by RUD.



AT HOME INTERNATIONALLY.

Not only our products, but also RUD's solution and consulting expertise are available to you all over the world. This is ensured by a large number of subsidiaries, associated companies and specialist RUD trade partners. Satisfied users of RUD lifting and lashing solutions can also be found in almost all industrial sectors.

TRADITION MEETS FUTURE.

Time and again, RUD is at the forefront of important developments. Many things considered standard today for lifting and lashing originated from RUD's think tank. In 1953, RUD was the first chain manufacturer to receive the inspection stamp H1 for high-strength chains, in 1972 it was the first to receive approval for grade 8 (H1-8) and in 2007 for round steel chains of the highest grade 12 (D1-12) (ICE). To simplify test processes, we have long equipped many products with RFID transponders as standard and offer a complete hardware and software system for efficient test management. The latest milestone: In 2019, RUD presented the first lifting point that "thinks" and can thus avoid dangerous transverse loads. And there is still a lot do for us to do. Join us into the future.

AWARD-WINNING SERVICE.

Numerous awards prove it: RUD's innovative strength and performance are outstanding – in the industry and beyond.



EFFICIENCY IN LIFTING AND MOVING? LET'S TALK ABOUT IT.

Production management, mechanical engineering:

**“MOVING LOADS MUST NOT ONLY BE SAFE,
BUT COST-EFFICIENT TOO.”**

“When you move heavy and valuable loads every day, cost efficiency is just as important as safety. That's why we need products that are beyond all doubt in terms of quality and that perfectly meet our high requirements. A long service life through the use of modern materials and high-quality workmanship is a very important efficiency criterion, but user friendliness is also very important to us. At the same time, we need a partner who can advise us on very specific projects and offer a tailor-made lifting solution. Because sometimes only an individual solution is ultimately safe and cost-effective.”

Technical consultancy, RUD Group:

**“THE CUSTOMER BENEFIT IS ALWAYS AT THE FOREFRONT
FOR US. AND IT IS NEVER ONE-DIMENSIONAL.”**

“At RUD we have a clear focus: We want to meet the needs of our customers in the best possible way. Both with 'standard products' and special solutions. Our modern material technologies such as ICE 120 and VIP 100 have set standards in many branches. This not only makes our products extremely reliable and low-wear, they are also exemplary in terms of ergonomics thanks to good ideas and clear weight advantages. The special feature: In the case of highly specialised lifting or transport challenges, we literally stand by our customers and advise them. Our experts listen carefully to you, offer detailed advice and then develop a very specific solution that perfectly suits the respective task. Whether it's about a new lifting application or the transport of very special loads.”



FIND OUT MORE ABOUT
THE PRODUCT SOLUTIONS
AT RUD.



RUD MILESTONES.

1875

Establishment of the "Rieger & Dietz Kettenfabrik" by Carl Rieger and Friedrich Dietz in Aalen-Unterkochen.



1953

RUD is the first chain manufacturer with test stamp H1 for high-strength quality chains.



1967

First chain manufacturer with approval for grade 5 (H1-5).

1981

Development of the first lifting points RBG (load ring for bolting) and RBS (load ring for welding).



1985

Expansion of the lifting point program to include the LBS (load ring for welding) and LBG (load ring for bolting).



1994

First chain manufacturer with approval for the VIP-Special grade 8S (H1-8S) with up to 30 % higher WLL than grade 8.



VRS as the first eyebolt with adjustable direction.



1945

Beginning of industrial quality chains manufacturing.



1972

First chain manufacturer with approval for grade 8 (H1-8).



1990

WBG (load ring thread).



1992

Certification of the quality management system according to DIN/ISO 9001.



Certified as the first chain manufacturer with integrated quality and environmental management system according to ISO 9001/14001.

2002

First universal lifting point type PP-S.



2006

Approval for grade 10 (VIP) (H1-10).



2010

W-ABA – first rigid lifting point that can be loaded on all sides.



2016

VLBG-PLUS – with Ø 45 % higher WLL.



2019

RUD BLUE-ID SYSTEM



OPTILASH-CLICK – the click-in lashing point by RUD. Fixed variant: OPTILASH-FIX.



2007

DNVGL approval as manufacturer of round steel link chains and accessories for lifting, lashing and towing according to GL regulations for metallic materials (Certificate WZ 1218 HH 3).

First chain manufacturer with approval for grade 12 (ICE) (D1-12).



2014

RUD is the first lashing and lifting means manufacturer to equip many products with RFID transponders.

Presentation of the ICE-BOLT® – a revolution in bolting technology.



2019

RUD ACP-TURNADO – the first lifting point, whose body rotates automatically in the direction of force.



PRACTICAL KNOWLEDGE:

THE VARIETY OF RUD LIFTING POINTS.

How to find the optimum solution for every application.

RUD lifting points have stood for top quality, ergonomics and safety in lifting technology and load securing for many decades. More than 700 tested boltable and weldable lifting point variants in load ranges up to 250 t meet maximum requirements in all areas of application in combination with the unique variety of application of our ICE- and VIP-lifting means. Thanks to its unique variety of models, RUD can supply the perfect lifting point for every conceivable application.

SPECIAL FEATURES OF RUD LIFTING POINTS.

RUD has long been focussing on solutions for demanding lift tasks. Many hundreds of application-specific products now make up the world's largest range of lifting points. Our modern and tested product solutions increase safety for people and loads as well as efficiency. They can also drastically reduce the handling times that are not included in any calculation.

The RUD range includes boltable lifting points with load capacities of up to 250 t and weldable versions with up to 100 t WLL. All load-bearing elements are 100 % crack-tested. They can withstand 4–5 times the WLL until they break. The boltable variants are powder-coated in the striking pink or magenta colour. At many points, the RUD design engineers have integrated patented wear markings and there are clear details showing the minimum WLL for the negative possible loading direction. The most common variants are tested by the Employer's Liability Insurance Association, which is documented by a test certificate and a test stamp.

DESIGN DOCUMENTS AND CALCULATION PROGRAMS.

RUD has design documents in 2D and 3D as well as calculation programs for the solution of your lifting tasks. This is important because when calculating the correct WLL of individual lifting points, a series of factors must be taken into account, such as:

- the number of strands to be lifted,
- the influence of the angle conditions during the lifting process
- the shape of the design part (symmetrical or asymmetrical).



WHAT IS ACTUALLY A LIFTING POINT?

A lifting point is an important part of the lifting means system and connects the load with the crane when lifting, turning, rotating and moving cargo. Lifting points are eyebolts, eyes, flanges etc. which the lifting means are attached to using hooks, shackles or other connecting elements.



WHAT TYPES OF LIFTING POINTS ARE AVAILABLE?

BOLTABLE LIFTING POINTS.

When it comes to lifting loads, boltable lifting points are generally used. In more than 40 years of experience with lifting points, RUD has continually developed them further and decisively improved them. Boltable lifting points can be installed as necessary. If they are no longer necessary or would get in the way during the further working process, they can be removed with little effort. Due to their wide range of threads, they can be attached to almost any load. This makes them very flexible in use.

RUD lifting points are designed for a dynamic load of at least 20,000 load cycles, they are tested at an overload of 50 %. Their WLL range from 100 kg to 250 t. The bolts on our lifting points for boltable connections are 100 % crack-tested. They offer quadruple safety in every loading direction. In addition, all the load-bearing parts have been crack-tested and load-tested in accordance with EN 1677.



WELDABLE LIFTING POINTS.

Weldable lifting points are used in approximately 25 % of the constructions. Weldable RUD lifting points (weld-on points) are permanently connected to the load. The advantage: There is no need to unscrew the lifting point, e.g. when rotating and turning loads. A clear plus in terms of safety. RUD weldable lifting points are designed for a dynamic load of at least 20,000 load cycles, they are tested at an overload of 50 %. Their WLL range from 630 kg to 100 t, allowing them to offer quadruple safety in every loading direction. In addition, all the load-bearing parts have been crack-tested and load-tested in accordance with EN 1677.

RUD weld-on points are suitable for every common welding process. The weld-on blocks consist of a easy to weld material and the suspension rings are made from drop-forged, high-strength quenched and tempered steel in lightweight construction. Clear specifications are always available for the corresponding welding preparation and execution. It is crucial that it is followed exactly and that the weld seam is then checked for correctness.

Important: Welding must be carried out by a qualified welder in accordance with DIN EN 2871. The material of the welding blocks can be found in the user manual. The connecting surfaces must be free of impurities, oil, paint etc.



RIGID AND ROTATING / SWIVEL LIFTING POINTS.

Boltable and weldable lifting points can be divided into rigid and rotating/swivelling lifting points.

- RIGID LIFTING POINTS.

Rigid lifting points are eyebolts or weldable D-rings. Because their pulling direction cannot be changed, they are preferably used in single leg lifts. They must therefore not be flexible.

- ROTATING AND SWIVEL LIFTING POINTS.

The area of application for rotating or swivelling lifting points is usually a multiple leg lift, because in this application the lifting points must align themselves in the direction of pull when the load is lifted. Rotating and swivelling lifting points are therefore more flexible than rigid variants.



WHAT DOES RISK ANALYSIS INVOLVE?

As a designer or user you should always carry out an appropriate risk analysis before you determine a lifting point. No matter whether it is an integrated suspension ring or an attachable lifting point. In doing so, please observe the following aspects:

- The lifting point should not have any sharp edges.
- The suspension ring diameter must be suitable for the hooks being used.
- Material thickness and distances from the edges must be chosen in a way that safety latches of hooks will not be damaged and fold in.
- The suspension must be designed with 4-fold protection against breakage in any direction, as loading forces in all conceivable directions could occur during manufacture, transport and assembly of the structure.
- An eye-catching colour for the marking of the lifting point is highly recommended.

WHAT IS THE RELEVANCE OF THE DESIGN?

This is another aspect that is becoming increasingly important: Today, a machine – to give you an example – is expected to offer not only technological advantages but also an attractive design. For this reason, many manufacturers consider it very important that an installed lifting point also meets the design requirements of the machine. Especially when it should stay permanently on the machine. With a DIN-580 eyebolt or a do-it-yourself weld-on block, these expectations can hardly be met. This is why RUD engineers have also attached great importance to a modern, contemporary design – for example with the patented octagon shape.



ROTATING AND TURNING LOADS WITH LIFTING POINTS.



Special RUD lifting points for rotating and turning have special application advantages and therefore a considerable added value. They are equipped with a ball bearing, making them the perfect choice for these applications.

The advantage: Thanks to the ball bearing, the forces resulting from lifting are converted shock-free into a rotating movement. Such shock-free rotation under load is not possible without ball bearings, because impact to the complete system cannot be avoided. Read how to use the lifting point properly below.

ROTATING AND TURNING: POINTS TO WATCH FOR WHEN SELECTING THE LIFTING POINT.

Clearance to the load.

- In the case of sensitive surfaces, choose a lifting point that guarantees enough clearance to the load and does not damage it.
- Important: choose suitable lifting means.
- Avoid contact of the lifting point with the load.

The tonnage.

- Take the overall weight of the load into account.
- Taking the rotating movement (swinging of the load) and resulting dynamism into account.
- Note the direction of rotation: Which direction does the load swing in?
- How is the load lifted?
- When determining the maximum WLL, take the calculation for a 2-leg suspension into account, as all legs generally do not bear the load.

The lifting point design.

- Is the lifting point centric or off-center?
- What requirements do the loaded goods make on the lifting process?

Attachment to the load: boltable or weldable.

- **Should the lifting point be boltable?**
This allows it to be mounted and removed as required.
- **Should the lifting point be weldable?**
In this way it remains permanently connected to the load and cannot untwist.

GENERAL SELECTION CRITERIA FOR LIFTING POINTS.

1. Determine the overall weight of the load.
2. Then determine the number of lifting points to be used according to the possible installation position.
3. In accordance with the operating instructions, observe the reduction factors resulting from the tilt angle and the temperature influences.
4. Select the correct lifting point according to the type of use with a WLL that exceeds the weight determined under point 3.



HOW MANY LIFTING POINTS CAN BE USED ON A LOAD?

- You can attach up to four lifting points on a construction, which you distribute depending on the properties of the load. During installation, ensure that the load hangs straight when being lifted and, for example, does not tilt – if necessary, use special lifting means from the RUD range.
- Important: Choose the right size of lifting point and tighten it properly.
- Also take into account that the WLL changes depending on the angle (steep angle: 0–45°, flat angle: 45–60°).



ASYMMETRICAL LOADS.

- Caution: With an asymmetrical load and several lifting points, one lifting point must bear the whole load in extreme cases, therefore load factor = 1.

DGUV rule 109-017

WHICH LIFTING POINT FOR WHICH CONSTRUCTION?

How to find the right product for your application.

Every construction with a dead weight exceeding 25 kg requires a suitable suspension or a device for attaching a lifting point – or several. This is not just a general view, it is the law. The specification is found in the European Machinery Directive 2006/42/EC 5. Their addressees are in particular designers of machines, plants, moulds etc.

The only question: Which lifting point is right for the task?

We provide you with sound decision-making aids and recommendations.



BOLTABLE LIFTING POINTS.

Features and applications.

“SMART” LIFTING POINT ACP-TURNADO

The suspension ring of a center pull hoist ring can easily get stuck in the worst case position when the load is lifted, resulting in a dangerous transverse load. These can damage or destroy the bolt. If the load then drops suddenly, this can cause damage to the cargo, lifting means or crane. With the ACP-TURNADO, a spring mechanism prevents the suspension ring from stopping at all. Instead it immediately turns in the loading direction when lifting the load. Moreover, it offers a much higher WLL with a comparable size. This makes the ACP-TURNADO the ideal lifting point if such damage is to be excluded at all costs.



LOAD RING TYPE VLBG-PLUS

Load rings such as the VLBG-PLUS are characterised by their extremely low construction with a pivoting suspension ring and an eccentric force introduction. An important advantage: They automatically align themselves correctly in the respective loading direction.

BOLTABLE LIFTING POINTS.

Features and applications.

VRS-STARPOINT

The VRS-STARPOINT in octagonal shape aligns itself around the installed bolt into the load force direction. This excludes dangerous untightening (like rigid DIN-580 bolts). Thanks to high-strength quenched and tempered steels and ICE-Bolt, the modern lifting point allows a 4 to 5 times higher WLL or half the diameter size than DIN 580. Current tests of the Employer's Insurance Association (BG) also confirm the positive tests in the worst critical loading direction of 90° in the load ring plane.

If the lifting points are only used during the manufacturing of a machine component, choose the VRS-STARPOINT variant with integrated Easy-Fit wrench. It can be installed and removed easily, quickly and without additional tools.

If the lifting points should stay permanently at the load they must be tightened with a recommend torque moment. This installation is particularly simple with a VRS socket wrench (suitable for a conventional torque wrench). Alternatively the use of bolt securing glue, f. e. Loctite is recommended.

The STARPOINT is available in several bolt lengths with corresponding washers and crack detected lock nuts in different thread types.



INOX-STAR

Is high resistance in sea water or in environments with high concentration of chlorine ions an important requirement? Then the INOX-STAR in penta shape (5-corner) and stainless version (made from 1.4462 Duplex steel) is the right choice.

EYE NUT VRM-STARPOINT

If threaded rods are provided at the load to attach a lifting points or if bolts can be inserted from the opposite side? Then VRM-STARPOINT might be the optimum solution. The VARIO eye nut is fastened with a ring spanner and the suspension ring can turn into the load direction.



POWERPOINT®

The PowerPoint®-Collection is a universal solution for a boltable lifting point. The products are equipped with double ball bearings and thus also take over the rotatable WLL 90° to the bolt-on direction.



- **Variant PP-VIP:**
A VIP-chain of the corresponding size can directly be connected to the clevis. This allows the shortest construction connection between two parts.



- **Variant PP-B:**
The patented clevis design allows the connection of various RUD-specific components, e.g. a suspension link to attach a hook or shackles.



- **Variant PP-S:**
With the PowerPoint®-Star, thanks to the movably mounted hook, all common lifting means such as round slings, wire ropes, chains and hooks can be universally connected (e.g. without shackles). It is the ideal variant for the designer, as he does not know in advance with which lifting means will be used to lift his construction. In addition, the large distance from the suspension protects the load from damage.

BOLTABLE LIFTING POINTS.

Features and applications.

RIGID LIFTING POINT B-ABA

A rigid bolttable lifting point like the B-ABA is always a sensible choice when the construction part is subjected to heavy vibration. But also when the lifting means are attached with one hand only. The nicely designed B-ABA can be loaded from any side and uses bolts made from the patented ICE-Bolt material.



LOAD RING VWBG

The VWBG load ring with ball bearing allows vertical rotation under full load. Tipping and flipping actions are therefore possible and safe. Even loading 90° (rectangular) to the ring plane is possible. This load force occurs, for example, when a plate must be pivot from the vertical into a horizontal position. Further advantages are a relatively small contact surface and the larger clearance of the suspension to the bolt-on surface. This means that even with a 90° loading, the attached hooks cannot damage the load.

LOAD RING VWBG-V

On the VWBG-V (V = Vario) the threaded part consists of a bolt (ICE-Bolt). This enables a higher WLL and the installation of a bolt of any length with a selectable thread type.



LOAD RING THREADED VRBG / RBG

If it makes sense to introduce force into the structure via several bolts in a way that is gentle on the component, there are several options depending on the load weight. The lifting points of the VRBG / RBG product family offer a swiveling ring lug, which ensures a low installation height. Depending on the load capacity, 2–8 crack-tested bolts are used for fastening. A load 90° to the ring plane is possible for all variants. The working load limit (WLL) ranges from 3.0 t to 100 t, thus enabling a high-performance solution even for high requirements.



FLANGE LOAD RING HEAD FLANGE T-FRB / BASE FLANGE B-FRB (“FLARIBO”)

The special solution “FLARIBO” (flange load ring) was developed to large tube segments, f.e. for wind towers. It fulfils a whole package of requirements: 180° pivoting, various flange diameters, split force introduction and a large distance between bolt-on surface and load to avoid damaging the tubes. In addition, it is equipped with a patented axial bushing disc for an optimised 90° WLL, which in turn has been transferred to side parts.



BOLTABLE LIFTING POINTS.

Features and applications.



LOAD RING-PLATE-THREADED WBPB

The removable suspension ring in the shape of a shackle is mounted by ball bearing and is 360° rotatable and 180° pivotable. With the WBPB, a WLL of up to 250 tons is possible.

ATTACHMENT BLOCK VABH-B

The VABH-B attachment block is ideal for trusses and beams, but also as a lifting point which has a WLL in a clearly defined direction and where lifting means are to be hooked in and secured as quickly as possible. The block with a robust, forged safety latch is fastened with ICE-Bolts and allows an extreme area of application of 150° in the hook plane and full lateral WLL up to 45°. It can be combined with all conventional lifting means without a connecting element. Weldable variant: VABH-W.



DIGRESSION: LASHING POINTS

Every machine, every mould and every large part is moved not only during production or in use, but also during transport to the place of use or installation. This is associated with dangers which can lead to considerable damage to the valuable load. Suitable, secure lashing points should therefore be considered at the design stage. Legislation also stipulates that machines, for example, must have suitable devices not only for lifting but also for horizontal road transport. Important for you: When lifting, the safety factor of lifting points must be 4 times the corresponding WLL, while lashing operations only ask for a safety factor of 2 times the permissible lashing force. Therefore lifting points must only be used as lashing points and cannot be used for lifting. Lifting points must only be loaded with a lashing force corresponding to the stated WLL.

WELDABLE LIFTING POINTS.

Features and applications.

LOAD RINGS VLBS AND LOAD RINGS VRBS/VRBK

Should the lifting point swivel to prevent dangerous tripping hazards?
Are no permanent rotary movements foreseeable with the construction part?
Then types VLBS and VRBS/VRBK are the right choice.

LOAD RING VLBS

Patented supporting noses are located inside the octagon-shaped forged D-Ring, which allows also loading in the 90° side direction of the suspension ring. A clamping spring underneath the weld-on block also reduces the generation of rattling noise.



Type VLBS is available in the following special designs:

- Type VLBS-P for welding on pipes with a pipe diameter of 80 mm to 220 mm.
- Type VLBS-U-LT with deep temperature usage down to -45 °C.



WELDABLE LIFTING POINTS.

Features and applications.

LOAD RING VRBS-FIX

The type VRBS-FIX is particularly suitable where it makes sense to apply the force through the weld seam at two points. This results in smaller and lower cost welds that are continuous (no crevice corrosion). The force can then be introduced onto thinner sheets. The patented bearing system also allows a perfect WLL up to 90° to the load ring plane of the 180° pivoting suspension ring – and this under full load. A patented radial clamping spring reduces the noise and keeps the weld-on blocks at a precisely defined distance during welding.



LOAD RING VRBK-FIX

For assemblies with 90° edges it often makes sense to fix the lifting points on the corners. This means that with one lifting point positioned at the corner instead of two lifting attached to each side surface loads can be rotated and turned. The type VRBK-FIX largely corresponds to the type VRBS-FIX with two split force introduction points. However, the weld-on block is designed so that it adapts exactly to the 90° edge of the load. A continuous circular HV weld seam prevents the lifting point from dreaded sub corrosion.





WPP

The Welding PowerPoint®-Collection is a universal solution for weldable lifting points. The products are equipped with double ball bearings. This offers the perfect solution for rotating and flipping actions under load. Thanks to the universal, nonmix-up VIP connection for chain, hook and eye, they can be combined with all standard lifting means without additional connecting elements.

LIFTING POINT W-ABA THAT CAN BE LOADED ON ALL SIDES

Rigid weld-on-blocks make sense:

- for construction parts that are subject to constant rotary motion, strong vibrations and shocks;
- if the height of the lifting points does not cause obstruction;
- if the lifting means are to be suspended with only one hand;
- for application on thinner workpieces.

On many constructions, however, you will find weld-on flame cutted plates, which have considerable and often serious disadvantages. The W-ABA from RUD (lifting point that can be loaded on all sides) meets all requirements for modern, safe lifting lugs – and all this in an attractive design. The requirements of DIN EN 1090 are fulfilled thanks to the endless circular fillet weld seam. Since there is no risk of contact/crevice corrosion, W-ABA can also be used for outdoor constructions.



INSTALLATION OF LIFTING POINTS.

Whether boltable or weldable:

Please observe the following:

- Design the lifting point so that the exerted forces can be absorbed by the base material without deformation.
- For boltable variants, the load and material must be suitable for bolting the lifting point in up to the contact surface.
- Attach the lifting point as follows to avoid impermissible stresses such as twisting or turning of the load:
 - Single strand attachment: vertically above the load centre.
 - Double strand attachment: above and on both sides of the centre of gravity.
 - Three- or four-strand attachment: evenly in one plane around the load's centre of gravity.
- Symmetry of load: Determine the necessary WLL of the individual lifting point for symmetrical and non-symmetrical loads using the following physical equation:

$$W_{LL} = \frac{G}{n \times \cos \beta}$$

W_{LL} = req. WLL of the lifting point / single strand (kg)

G = Load weight (kg)

n = Number of supporting strands

β = Inclination angle of the individual strands

- Prevent any damage to the lifting means by a WLL with sharp edges.
- Check the lifting points regularly and before each commissioning for a tight bolt fitting (torque moment), heavy corrosion, wear occurrence, cracks in the weld seam, deformations etc.

IMPORTANT:

When installing the lifting points, follow the instructions supplied.



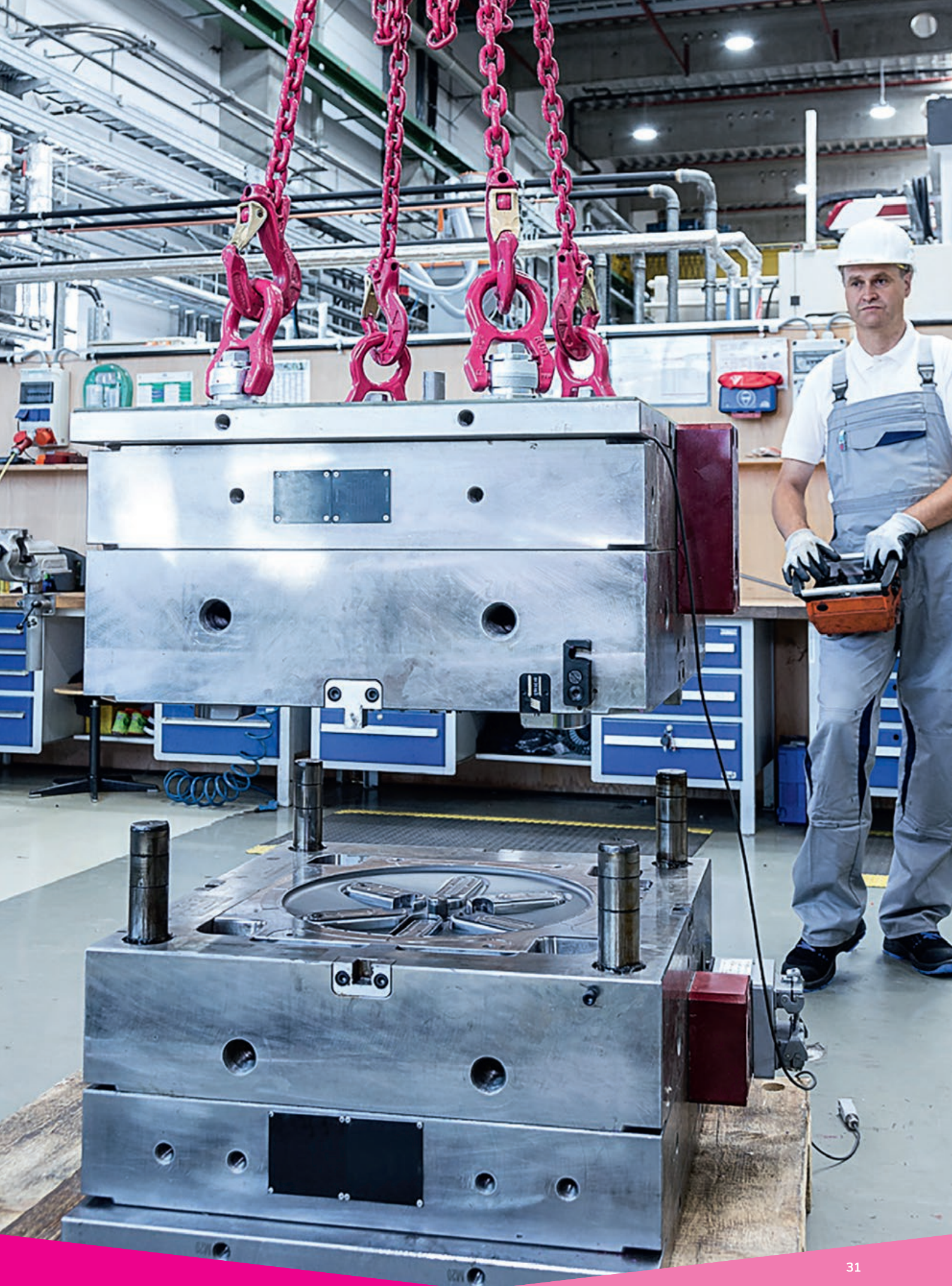

ICE-BOLT – THE NEW BOLT CLASS FOR LIFTING POINTS.

FROM THE CHAIN TO THE BOLT.

When it comes to materials for lifting means or lifting points, RUD has always been one step ahead of its time. RUD's specialists developed the well-known ICE-chain a few years ago. Thanks to the "Innovative Chain Evolution", an ICE-lifting or lashing chain can now replace a grade 8 chain of the next larger nominal thickness. The advantage: The dead weight of the pink-coloured chain is more than 30 percent lower, the working ergonomics are noticeably higher.

HIGH SAFETY EVEN AT LOW TEMPERATURES AND EXTREMELY HIGH TEMPERATURES.

However, not only chains, but also the flanges of modern rotatable lifting points perform very hard work. Every day they have to withstand the highest WLL. And not just in one direction, but in every conceivable one. These extreme bending and shearing forces must be safely absorbed both statically and dynamically. This is just as true at Arctic deep temperatures as it is at extremely high temperatures.



THE ICE-BOLT: HIGHER WLL WITH SMALLER BOLT DIAMETERS.

After intensive development work, the RUD engineers succeeded in transferring the innovative ICE-material to the fastening bolts of the RUD lifting points: The ICE-Bolt was born. After all, the patented fine-grained steel of the ICE-chain is virtually predestined to meet the high safety requirements in lifting technology. For example, the breaking forces of M8–M16 could be increased by 88 % compared to 8.8 bolts and by 44 % compared to 10.9 bolts. This allows an M24 ICE-Bolt to be used instead of an M30-8.8 bolt. And this with at least the same, but usually higher breaking force. In terms of bending strength, the ICE-Bolt effortlessly beats grades 10.9 and 12.9 and even approaches the values of 8.8 bolts.

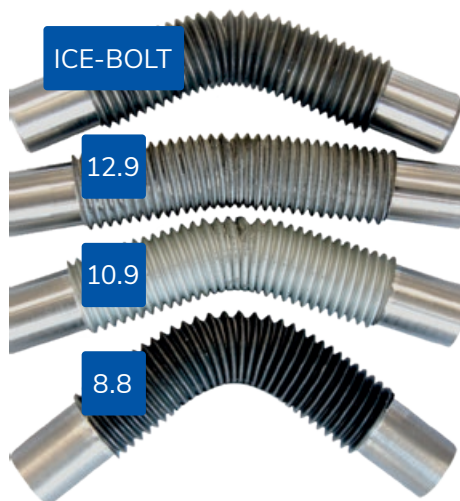

SAFETY MEETS ECONOMY: THE DECISIVE ADVANTAGES OF THE ICE-BOLT.

- Higher WLL or thinner bolt diameters.
- Unmatched high safety factors.
- Incomparable low temperature resistance down to -60°C .
- Maximum strength with particularly high toughness.
- Particularly high bending resistance at the critical transition between load absorption and load.
- Lower wear.

The thread of the ICE-Bolt proves itself in the prism bending test. The test shows: the ICE-Bolt masters static and dynamic WLL safely.

In brief: RUD lifting points with ICE-Bolts represent maximum safety – and in quality class 12.

INCREASE IN THE BREAKING FORCE THANKS TO ICE-BOLT.

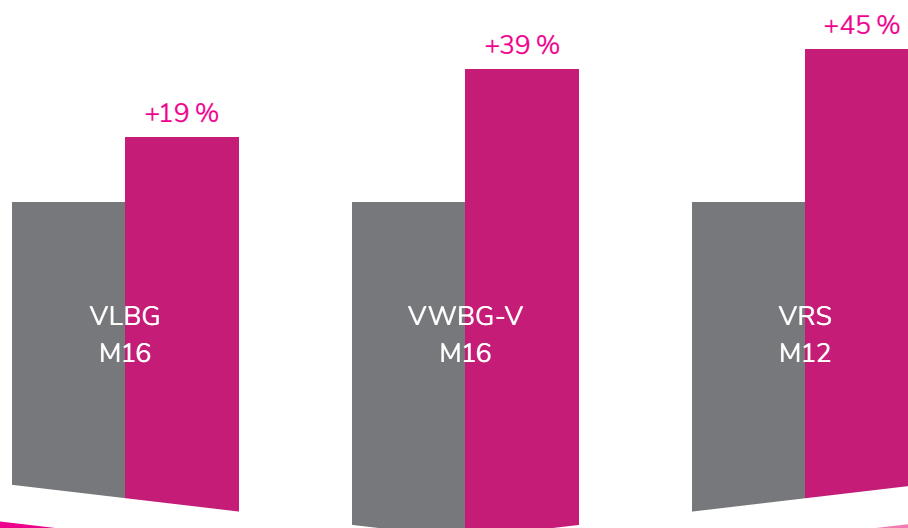

SIMPLE PRODUCT INSPECTING WITH RFID TECHNOLOGY.



THE RUD BLUE-ID SYSTEM: IDENTIFY. TRANSMIT. MANAGE.

From RFID transponders and readers to a documentation and management software: With the RUD BLUE SYSTEM we offer you a comfortable overall solution for inspecting your equipment. This noticeably relieves your daily workload and saves costs.

The wireless and safe transmission via RFID transponders makes the product identification more convenient than ever. And with our readers and the software solution, documentation and administration also become incredibly easy. Thus, with a single click, all RUD components with RFID tags can be identified contact-free and without errors and transmitted directly to the software or app for further processing of the test data. It could not be more convenient or more secure. Your entire inspecting process will be simpler, faster and more reliable. This gives you more time for your core business.

THE RUD BLUE-ID SYSTEM.

- Lower inspection costs, time and personnel expenditure.
- More process and legal security (avoidance of errors).
- Factory preassigned product information simple, contact-free and fast readout on site.
- Clear marking and identification of the products with RFID technology.
- Offline inspecting possible without Internet access.
- Simple documentation and administration of test data with the cloud based software solution AYE-D.NET.



Serially embedded in defined RUD products.
Can be retrofitted for many other products.



If you see this symbol next to the image of an RUD product, you know:
An RFID transponder is installed here.

THE HARDWARE. FLEXIBLE, ADAPTABLE, RESISTANT.



RFID transponders are already integrated as standard in defined RUD products. In addition, we offer you numerous possibilities to retrofit components safely and permanently with one of our transponders. Each of them is extremely resistant and can withstand even the harshest environmental conditions such as extreme temperatures or chemically aggressive substances.



The RUD ID-POINT®.
The press-fit version.



The RUD ID-STICKER.
The glue version.



The RUD ID-TAG®.
The hinge version.



The RUD ID-USB-READER.



The RUD ID-LINK®.
The sagging version.



THE SOFTWARE. POWERFUL, MODULAR, EASY TO USE.

As a combination of testing, administration and documentation software, AYE-D.NET opens up numerous possibilities in testing administration and subsequent processes. We offer the cloud-based software tool as a SaaS solution together with our partner Syfit. Alternatively, you can organise the test documentation with existing databases and standard programmes such as Office applications, SAP etc.

See product data on site immediately with one click via rud.com or the AYE-D.NET app (designation, WLL, test data etc.)

<p>RFID TRANSPONDER PROGRAM</p> <p>Flexible variety: can be pressed in, glued on, hooked in or bent in.</p>	<p>USB READER</p> <p>For contactless and secure reading of the ID number.</p>	<p>AYE-D.NET SOFTWARE SOLUTION</p> <p>Cloud-based solution of our partner Syfit for documentation and maintenance of the test data.</p> <hr/> <p>CUSTOMER-SPECIFIC SOLUTION</p> <p>Individual and flexible documentation and maintenance of test data with customer-specific database. Office solution like MS Word, MS Excel, SAP or another program.</p>
--	--	--

Legally compliant, time and cost-saving product test and test documentation.

WLL BOLTABLE LIFTING POINTS.

THREAD SIZES M6–M150												
Number of strands			1	2	1	2	2	2	2	3+4	3+4	3+4
Load direction			0°	0°	90°	90°	0–45°	45–60°	non-symmetrical	0–45°	45–60°	non-symmetrical
Type	Thread size											
	ACP-TURNADO 0.7t	M8	0.7	1.4	0.7	1.4	0.98	0.7	0.7	1.47	1.05	0.7
	ACP-TURNADO 1t	M10	1	2	1	2	1.4	1	1	2.1	1.5	1
	ACP-TURNADO 1.35t	M12	1.35	2.7	1.35	2.7	1.9	1.35	1.35	2.84	2	1.35
	ACP-TURNADO 2.5t	M16	2.5	5	2.5	5	3.5	2.5	2.5	5.25	3.75	2.5
	ACP-TURNADO 4t	M20	4	8	4	8	5.6	4	4	8.4	6	4
	ACP-TURNADO 6.3t	M24	6.3	12.6	6.3	12.6	8.8	6.3	6.3	13.2	9.45	6.3
	ACP-TURNADO 8t	M30	8	16	8	16	11.2	8	8	17	12	8
	ACP-TURNADO 12.5t	M36	15	30	12.5	25	17	12.5	12.5	26.5	19	12.5
	ACP-TURNADO 16t	M42	18	36	16	32	22.4	16	16	33.6	24	16
	VLBG-PLUS 0.63t	M8	0.63	1.26	0.63	1.26	0.88	0.63	0.63	1.32	0.95	0.63
	VLBG-PLUS 0.9t	M10	0.9	1.8	0.9	1.8	1.3	0.9	0.9	1.9	1.35	0.9
	VLBG-PLUS 1.35t	M12	1.35	2.7	1.35	2.7	1.9	1.35	1.35	2.84	2	1.35
	VLBG-PLUS 2t	M16	2	4	2	4	2.8	2	2	4.25	3	2
	VLBG-PLUS 3.5t	M20	3.5	7	3.5	7	4.9	3.5	3.5	7.35	5.25	3.5
	VLBG-PLUS 4.5t	M24	4.5	9	4.5	9	6.3	4.5	4.5	9.5	6.75	4.5
	VLBG-PLUS 6.7t	M30	6.7	13.4	6.7	13.4	9.5	6.7	6.7	14.1	10	6.7
	VLBG-PLUS 7t	M36	7	14	7	14	9.8	7	7	14.7	10.5	7
	VLBG-PLUS 8t	M36	8	16	8	16	11.2	8	8	17	11.8	8
	VLBG-PLUS 10t	M42	10	20	10	20	14	10	10	21.2	15	10
	VLBG-PLUS 15t	M42	15	30	15	30	21.2	15	15	31.5	22.4	15
	VLBG-PLUS 20t	M48	20	40	20	40	28	20	20	42	30	20
		VWBG-V 0.3t	M8	0.6	1.2	0.3 (0.4) ¹	0.6 (0.8) ¹	0.42 (0.56) ¹	0.3 (0.4) ¹	0.3 (0.4) ¹	0.63 (0.84) ¹	0.45 (0.6) ¹
VWBG-V 0.45t		M10	0.9	1.8	0.45 (0.6) ¹	0.9 (1.2) ¹	0.63 (0.84) ¹	0.45 (0.6) ¹	0.45 (0.6) ¹	0.94 (1.26) ¹	0.67 (0.9) ¹	0.45 (0.6) ¹
VWBG-V 0.6t		M12	1.2	2.4	0.6 (0.75) ¹	1.2 (1.5) ¹	0.84 (1) ¹	0.6 (0.75) ¹	0.6 (0.75) ¹	1.26 (1.57) ¹	0.9 (1.12) ¹	0.6 (0.75) ¹
VWBG-V 1t		M14	2	4	1 (1.25) ¹	2 (2.5) ¹	1.4 (1.75) ¹	1 (1.25) ¹	1 (1.25) ¹	2.1 (2.62) ¹	1.5 (1.87) ¹	1 (1.25) ¹
VWBG-V 1.3t		M16	2.6	5.2	1.3 (1.5) ¹	2.6 (3) ¹	1.82 (2.1) ¹	1.3 (1.5) ¹	1.3 (1.5) ¹	2.73 (3.15) ¹	1.95 (2.25) ¹	1.3 (1.5) ¹
VWBG-V 1.8t		M18	3.6	7.2	1.8 (2) ¹	3.6 (4) ¹	2.52 (2.8) ¹	1.8 (2) ¹	1.8 (2) ¹	3.75 (4.25) ¹	2.7 (3) ¹	1.8 (2) ¹
VWBG-V 2t		M20, M22	4	8	2 (2.5) ¹	4 (5) ¹	2.8 (3.5) ¹	2 (2.5) ¹	2 (2.5) ¹	4.25 (5.25) ¹	3 (3.75) ¹	2 (2.5) ¹
VWBG-V 3.5t		M24, M27	7	14	3.5 (4) ¹	7 (8) ¹	4.9 (5.6) ¹	3.5 (4) ¹	3.5 (4) ¹	7.35 (8.4) ¹	5.25 (6) ¹	3.5 (4) ¹
VWBG-V 5t		M30	10	20	5 (6) ¹	10 (12) ¹	7 (8.4) ¹	5 (6) ¹	5 (6) ¹	10.6 (12.6) ¹	7.5 (9) ¹	5 (6) ¹

¹ () = Higher WLL by optimised attachment or application.

Maximum transport weight "G" in [t] with different lifting methods.

- All load-bearing parts are crack-tested or test-loaded according to EN 1677.
- In boltable RUD lifting points, the bolts are also 100 % crack-tested.
- 4-times the safety in every loading direction.
- Types ACP, VLBG, VLBG-PLUS, VRS, VRM, VWBG-V, PP and INOX-STAR can be adjusted in all loading directions.
- Low installation heights, and high dynamic and static strengths.

WLL BOLTABLE LIFTING POINTS.

THREAD SIZES M6–M150												
Number of strands		1	2	1	2	2	2	2	3 + 4	3 + 4	3 + 4	
Load direction		0°	0°	90°	90°	0–45°	45–60°	non-symmetrical	0–45°	45–60°	non-symmetrical	
Type	Thread size											
	VWBG 6 (7.5) t	M33	15	30	6 (7.5) ¹	12 (15) ¹	8.4 (10.5) ¹	6 (7.5) ¹	6 (7.5) ¹	12.6 (15.75) ¹	9 (11.25) ¹	6 (7.5) ¹
	VWBG 8 (10) t	M36–39	15	30	8 (10) ¹	16 (20) ¹	11.2 (14) ¹	8 (10) ¹	8 (10) ¹	17 (21.2) ¹	11.8 (15) ¹	8 (10) ¹
	VWBG 12 (13) t	M42–45	17	34	12 (13) ¹	24 (26) ¹	16.8 (18.2) ¹	12 (13) ¹	12 (13) ¹	25.2 (27.3) ¹	18 (19.5) ¹	12 (13) ¹
	VWBG 12 (15) t	M45	18	36	12 (15) ¹	24 (30) ¹	16.8 (21.2) ¹	12 (15) ¹	12 (15) ¹	25.2 (31.5) ¹	18 (22.4) ¹	12 (15) ¹
	VWBG 13 (16) t	M48–52	18	36	13 (16) ¹	26 (32) ¹	18.2 (22.4) ¹	13 (16) ¹	13 (16) ¹	27.3 (33.6) ¹	19.5 (24) ¹	13 (16) ¹
	VWBG 14 (20) t	M52	25	50	14 (20) ¹	28 (40) ¹	19.6 (28) ¹	14 (20) ¹	14 (20) ¹	29.4 (42) ¹	21 (30) ¹	14 (20) ¹
	VWBG 16 (22) t	M56–62	28	56	16 (22) ¹	32 (44) ¹	22.4 (30.8) ¹	16 (22) ¹	16 (22) ¹	33.6 (46.2) ¹	24 (33) ¹	16 (22) ¹
	VWBG 16 (25) t	M64–76	28	56	16 (25) ¹	32 (50) ¹	22.4 (35) ¹	16 (25) ¹	16 (25) ¹	33.6 (52.5) ¹	24 (37.5) ¹	16 (25) ¹
	VWBG 31.5 (40) t	M72–76	50	100	31.5 (40) ¹	63 (80) ¹	45 (56) ¹	31.5 (40) ¹	31.5 (40) ¹	67 (84) ¹	47.5 (60) ¹	31.5 (40) ¹
	VWBG 35 (48) t	M80–85	50	100	35 (48) ¹	70 (96) ¹	49 (67.2) ¹	35 (48) ¹	35 (48) ¹	73.5 (100.8) ¹	52.5 (72) ¹	35 (48) ¹
VWBG 40 (50) t	M90–150	50	100	40 (50) ¹	80 (100) ¹	56 (70) ¹	40 (50) ¹	40 (50) ¹	84 (105) ¹	60 (75) ¹	40 (50) ¹	
	WBPB 85 t	6 x M48	85	170	85	170	119	85	85	178	127	85
	WBPB 100 t	6 x M48	100	200	100	200	140	100	100	210	150	100
	WBPB 200 t	10 x M48	200	400	200	400	280	200	200	420	300	200
	WBPB 250 t	12 x M48	250	500	250	500	350	250	250	525	375	250
	PP 0.63 t	M12	0.63	1.26	0.63	1.26	0.88	0.63	0.63	1.32	0.95	0.63
	PP 1.5 t	M16	1.5	3	1.5	3	2.1	1.5	1.5	3.15	2.24	1.5
	PP 2.5 t	M20	2.5	5	2.5	5	3.5	2.5	2.5	5.25	3.75	2.5
	PP 4 t	M24	4	8	4	8	5.6	4	4	8.4	6	4
	PP 5 t	M30	6.7	13.4	5	10	7.1	5	5	10.6	7.5	5
	PP 8 t	M36	10	20	8	16	11.2	8	8	17	11.8	8

¹ () = Higher WLL by optimised attachment or application.

Maximum transport weight "G" in [t] with different lifting methods.

- The RUD lifting points homepage facilitates the correct design of lifting points.
- RUD lifting points are designed for a max. dynamic load of 20,000 load cycles (tested at 50 % overload).
- Ask the manufacturer in case of a higher dynamic WLL.

WLL BOLTABLE LIFTING POINTS.

THREAD SIZES M6–M150												
Number of strands		1	2	1	2	2	2	2	3 + 4	3 + 4	3 + 4	
Load direction		0°	0°	90°	90°	0-45°	45-60°	non-symmetrical	0-45°	45-60°	non-symmetrical	
Type	Thread size											
	VRS M6 / VRM M6 ¹	M6	0.5	1	0.1	0.2	0.14	0.1	0.1	0.21	0.15	0.1
	VRS M8 / VRM M8 ¹	M8	1	2	0.3	0.6	0.42	0.3	0.3	0.63	0.45	0.3
	VRS M10 / VRM M10 ¹	M10	1	2	0.4	0.8	0.56	0.4	0.4	0.84	0.6	0.4
	VRS M12 / VRM M12 ¹	M12	2	4	0.75	1.5	1	0.75	0.75	1.57	1.12	0.75
	VRS M16 / VRM M16 ¹	M16	4	8	1.5	3	2.1	1.5	1.5	3.15	2.25	1.5
	VRS M20 / VRM M20 ¹	M20	6	12	2.3	4.6	3.22	2.3	2.3	4.83	3.45	2.3
	VRS M24 / VRM M24 ¹	M24	8	16	3.2	6.4	4.5	3.2	3.2	6.7	4.8	3.2
	VRS M30 / VRM M30 ¹	M30	12	24	4.5	9	6.3	4.5	4.5	9.5	6.75	4.5
	VRS M36	M36	16	32	7	14	9.8	7	7	14.7	10.5	7
	VRS M42	M42	24	48	9	18	12.6	9	9	18.9	13.5	9
	VRS M48	M48	32	64	12	24	16.8	12	12	25.2	18	12
	VRS M56	M56	50	100	16	32	22.4	16	16	33.6	24	16
	VRS M64	M64	60	120	20	40	28	20	20	42	30	20
		INOX M12	M12	1.2	2.4	0.5	1	0.71	0.5	0.5	1.06	0.75
INOX M16		M16	2.4	4.8	1	2	1.4	1	1	2.1	1.5	1
INOX M20		M20	3.6	7.2	2	4	2.8	2	2	4.25	3	2
INOX M24		M24	5.2	10.4	2.5	5	3.5	2.5	2.5	5.25	3.75	2.5
	RS M6 / RM M6 ²	M6	0.4	0.8	0.1	For this type of suspension we recommend the use of the adjustable "VRS-Starpoint" in the direction of force!						
	RS M8 / RM M8 ²	M8	0.8	1.6	0.2							
	RS M10 / RM M10 ²	M10	1	2	0.25							
	RS M12 / RM M12 ²	M12	1.6	3.2	0.4							
	RS M14 / RM M14 ²	M14	3	6	0.75							
	RS M16 / RM M16 ²	M16	4	8	1(0.8)							
	RS M20 / RM M20 ²	M20	6	12	1.5							
	RS M24 / RM M24 ²	M24	8	16	2							
	RS M30 / RM M30 ²	M30	12	24	3							
	RS M36 / RM M36 ²	M36	16	32	4							
	RS M42 / RM M42 ²	M42	24	48	6							
RS M48 / RM M48 ²	M48	32	64	8								
	RBG 3t	2 x M16	3	6	3	6	4.25	3	3	6.3	4.5	3
	VRBG 10t	4 x M20	10	20	10	20	14	10	10	21.2	15	10
	VRBG 16t	4 x M30	16	32	16	32	22.4	16	16	33.6	24	16
	VRBG 31.5t	6 x M30	31.5	63	31.5	63	45	31.5	31.5	67	47.5	31.5
	VRBG 50t	8 x M36	50	100	50	100	70	50	50	105	75	50
	VRBG 100t	8 x M48	100	200	100	200	140	100	100	210	150	100
	B-ABA 1.6t	4 x M10	1.6	3.2	1.6	3.2	2.2	1.6	1.6	3.4	2.4	1.6
	B-ABA 3.2t	4 x M12	3.2	6.4	3.2	6.4	4.5	3.2	3.2	6.7	4.8	3.2
	B-ABA 5t	4 x M16	5	10	5	10	7.1	5	5	10.6	7.5	5
	B-ABA 10t	4 x M20	10	20	10	20	14	10	10	21.2	15	10
	B-ABA 20t	6 x M24	20	40	20	40	28	20	20	42	30	20
	B-ABA 31.5t	6 x M30	31.5	63	31.5	63	45	31.5	31.5	67	47.5	31.5

¹ WLL values of VRM only apply in conjunction with thread bolts of quality class 10.9 min.

² WLL values of RM only apply in conjunction with thread bolts of quality class 8.8 min.

Maximum transport weight "G" in [t] with different lifting methods.

WLL WELDABLE LIFTING POINTS.

WLL 630 kg–100 t												
Number of strands		1	2	1	2	2	2	2	3+4	3+4	3+4	
Load direction		0°	0°	90°	90°	0–45°	45–60°	non-symmetrical	0–45°	45–60°	non-symmetrical	
Type	Welding seam											
	WPP / WPPH 0.63t	4	0.63	1.26	0.63	1.26	0.88	0.63	0.63	1.32	0.95	0.63
	WPP / WPPH 1.5t	5	1.5	3	1.5	3	2.1	1.5	1.5	3.15	2.25	1.5
	WPP / WPPH 2.5t	HY3+5	2.5	5	2.5	5	3.5	2.5	2.5	5.25	3.75	2.5
	WPP / WPPH 4t	HY3+6	4	8	4	8	5.6	4	4	8.4	6	4
	WPP / WPPH 5t	HY3+8	6.7	13.4	5	10	7.1	5	5	10.6	7.5	5
	WPP / WPPH 8t	HY3+10	10	20	8	16	11.2	8	8	17	11.8	8
	VLBS 1.5t	HV5+3	1.5	3	1.5	3	2.1	1.5	1.5	3.15	2.25	1.5
	VLBS 2.5t	HV7+3	2.5	5	2.5	5	3.5	2.5	2.5	5.25	3.75	2.5
	VLBS 4t	HV8+3	4	8	4	8	5.6	4	4	8.4	6	4
	VLBS 6.7t	HV12+4	6.7	13.4	6.7	13.4	9.5	6.7	6.7	14.1	10	6.7
	VLBS 10t	HV16+4	10	20	10	20	14	10	10	21.2	15	10
	VRBS-FIX 4t	HY3	4	8	4	8	5.6	4	4	8.4	6	4
	VRBS-FIX 6.7t	HY5	6.7	13.4	6.7	13.4	9.5	6.7	6.7	14.1	10	6.7
	VRBS-FIX 10t	HY6	10	20	10	20	14	10	10	21.2	15	10
	VRBS-FIX 16t	HY9	16	32	16	32	22.4	16	16	33.6	24	16
	VRBS-FIX 31.5t	HY19	31.5	63	31.5	63	45	31.5	31.5	67	47.5	31.5
	VRBS-FIX 50t	HY25+8	50	100	50	100	70	50	50	105	75	50
	VRBK-FIX 4t	HY3+4	4	8	4	8	5.6	4	4	8.4	6	4
	VRBK-FIX 6.7t	HY5+3	6.7	13.4	6.7	13.4	9.5	6.7	6.7	14.1	10	6.7
	VRBK-FIX 10t	HY8+3	10	20	10	20	14	10	10	21.2	15	10
	VRBK-FIX 16t	HY10	16	32	16	32	22.4	16	16	33.6	24	16
	VRBK-FIX 31.5t	HY17	31.5	63	31.5	63	45	31.5	31.5	67	47.5	31.5
	VRBK-FIX 50t	HY25	50	100	50	100	70	50	50	105	75	50
	W-ABA 0.8t ³	3	0.8 (2)	1.6 (4)	0.8 (2)	1.6 (4)	1.12 (2.8)	0.8 (2)	0.8 (2)	1.7 (4.25)	1.18 (3)	0.8 (2)
	W-ABA 1.6t ³	4	1.6 (4)	3.2 (8)	1.6 (4)	3.2 (8)	2.2 (5.6)	1.6 (4)	1.6 (4)	3.4 (8.4)	2.4 (6)	1.6 (4)
	W-ABA 3.2t ³	6	3.2 (9)	6.4 (18)	3.2 (9)	6.4 (18)	4.5 (12.6)	3.2 (9)	3.2 (9)	6.7 (18.9)	4.8 (13.5)	3.2 (9)
	W-ABA 5t ³	7	5 (12)	10 (24)	5 (12)	10 (24)	7.1 (16.8)	5 (12)	5 (12)	10.5 (25.2)	7.5 (18)	5 (12)
	W-ABA 10t ³	8	10 (20)	20 (40)	10 (20)	20 (40)	14 (28)	10 (20)	10 (20)	21.2 (42)	15 (30)	10 (20)
	W-ABA 20t	12	20	40	20	40	28	20	20	42	30	20
	W-ABA 31.5t	15	31.5	63	31.5	63	45	31.5	31.5	67	47.5	31.5











³ () = Higher WLL by optimised attachment or application.

























Maximum transport weight "G" in [t] with different lifting methods.



BOLTABLE LIFTING POINTS.

OVERVIEW OF BOLTABLE LIFTING POINTS.







p. 44		ACP-TURNADO 0.7t-8t
p. 47		ACP-TURNADO 12.5t-16t
p. 50		VLBG-PLUS / VLBG / VLBG-Z 0.63t-20t
p. 54		PP-S / -B / -VIP 0.63t-10t
p. 60		TXP-TEXOLUTION-POINT 1.3t-3t
p. 62		VWBG-V / VWBG 0.3t-5t/6t-50t
p. 68		WBPB 85t-250t
p. 70		VRS-STARPOINT 0.1t-20t
p. 76		VRM-STARPOINT 0.1t-4.5t
p. 77		INOX-STAR 0.5t-2.5t











																										
	Ideal for rotating and turning	Ball bearing mounted	Safety factor 4:1	Safety factor 5:1	100% electromagnetically crack-tested	WLL possible on all sides or turning into load direction	Retaining spring	Turning range	360°	XXX°	M	MF	UNC	8-UN	UNF	BSW - British Standard Whitworth	G - pipe inch (according to ISO 228)	Variable thread lengths	Operating temperature range without reduction in working load limit	Max. application temperature with WLL reduction	Equipped with ICE-Bolt	RUD BLUE-ID SYSTEM	DGVV approval	Certified according to the DNVGL guideline	Safety standard for lifting accessories	
			■	■	■	■		■	■	■			■					■	■	■	■	■			■	
			■	■	■	■		■	■	■			■					■	■	■	■	■			■	
	■	■	■		■	■		■	■	■	■	■	■			■	■	■	■	■	■	■	■	■		
	■	■	■		■	■		■	■	■	■	■	■			■	■	■	■	■	■	■	■	■		
	■	■	■		■	■		■	■	■	■	■	■			■	■	■	■	■	■	■	■	■		
	■	■	■		■	■		■	■	■	■	■	■			■	■	■	■	■	■	■	■	■		
	■	■	■		■	■		■	■	■	■	■	■			■	■	■	■	■	■	■	■	■		
	■	■	■		■	■		■	■	■	■	■	■			■	■	■	■	■	■	■	■	■		



BOLTABLE LIFTING POINTS.

OVERVIEW OF BOLTABLE LIFTING POINTS.

p. 78		VWBM 0.6t-1.8t
p. 80		RS / RM 0.1t-8t
p. 86		VABH-B 1.5t-6.7t
p. 88		VCGH-G 10t-20t
p. 90		B-ABA 1.6t-31.5t
p. 92		RBG / VRBG / VRBG-FIX 3t-100t
p. 96		T-FRB / B-FRB
p. 98		PSA-INOX-STAR / PSA-VRS-STARPOINT 1-2 persons

			4:1	lbs 5:1						M	MF	UNC	8-UN	UNF	BSW	G	VARIO	 XXX° XXX°C	 XXX°C max.			DGUV TEST	DNVGL TEST	ASME B30.26	
	Ideal for rotating and turning	Ball bearing mounted	Safety factor 4:1	Safety factor 5:1	100% electromagnetically crack-tested	WLL possible on all sides or turning into load direction	Retaining spring	Turning range	Pivoting area/hook-in link	Metric thread	Metric fine thread	UNC inch thread	8UN inch thread	UNF inch thread	BSW – British Standard Whitworth	G – pipe inch (according to ISO 228)	Variable thread lengths	Operating temperature range without reduction in working load limit	Max. application temperature with WLL reduction	Equipped with ICE-Bolt	RUD BLUE-ID SYSTEM	DGUV approval	Certified according to the DNVGL guideline	Safety standard for lifting accessories	
	■	■	■		■	■		■	■	■								■	■		■				
			■		■					■	■	■	■	■	■	■	■		■	■	■	■			
			■		■					■									■	■	■	■			
			■		■	■			■	■								■	■	■	■	■	■		
	■		■		■	■			■	■								■	■	■		■			
			■		■	■		■		■	■							■	■			■			

ACP-TURNADO

Automatic-Center-Point.



RUD RFID
CONNECT IT



PRODUCT FEATURES

- Large WLL range 0.7 t–8 t.
- Higher WLL compared to other existing designs.
- Unique RUD spring mechanism.
- No stopping of lift bale at worst case position.
- No dangerous transverse loads.
- No kinking.
- Equipped with RUD ICE-Bolt up to size M24.
- Pivots 180°, rotates 360°.



For more information:
acp-turnado.com

✓ Component corresponds with the test criteria of BG/DGUV "GS-OA-15-04".

ACP-TURNADO

Metric thread / metric thread in variable length.

ACP-TURNADO – ICE-BOLT THREAD – METRIC.

Type	WLL [t]	Weight (kg/unit)	T [mm]	B [mm]	C [mm]	D [mm]	E [mm]	F [mm]	G [mm]	H [mm]	I [mm]	K [mm]	L [mm]	M	N [mm]	Tightening torque [Nm]	Ref. No.
ACP-TURNADO 0.7 t M8	0.7	0.36	83	11	10.5	38	30	12	28	45.3	13	58	40	M8	5	30	7912061
ACP-TURNADO 1 t M10	1	0.37	83	11	10.5	38	30	16	28	50.4	17	58	44	M10	6	60	7912064
ACP-TURNADO 1.35 t M12	1.35	0.38	83	11	10.5	38	30	19	28	54.5	19	58	47	M12	8	80	7909314
ACP-TURNADO 2.5 t M16	2.5	0.88	107	14	14	50	40	22	36	68	24	76	58	M16	10	150	7909316
ACP-TURNADO 4 t M20	4	1.41	118	17	17.25	50	45	26.5	43.5	82.5	30	89	70	M20	12	300	7909317
ACP-TURNADO 6.3 t M24	6.3	3.27	154	23	23	66	60	34	55	104	36	121	89	M24	14	500	7909318
ACP-TURNADO 8 t M30	8	5.69	183	29	27	75	75	41.5	68.5	129	46	148	110	M30	17	800	7909319

Subject to technical changes!

ACP-TURNADO – METRIC IN VARIABLE LENGTH INCL. SECURING NUT AND WASHER.

Type	WLL [t]	Weight (kg/unit)	T [mm]	B [mm]	C [mm]	D [mm]	E [mm]	F vario [mm]	G [mm]	H vario [mm]	I [mm]	K [mm]	L vario [mm]	M	N [mm]	Tightening torque [Nm]	Ref. No.
ACP-TURNADO 0.7 t M8	0.7	¹	83	11	10.5	38	30	8-77	28	41.3-110.3	13	58	36-105	M8	5	30	8600630
ACP-TURNADO 1 t M10	1	¹	83	11	10.5	38	30	10-97	28	44.4-131.4	17	58	38-125	M10	6	60	8600631
ACP-TURNADO 1.35 t M12	1.35	¹	83	11	10.5	38	30	12-117	28	55-153	19	58	40-145	M12	8	80	8600632
ACP-TURNADO 2.5 t M16	2.5	¹	107	14	14	50	40	16-149	36	68-195	24	76	52-185	M16	10	150	8600634
ACP-TURNADO 4 t M20	4	¹	118	17	17.25	50	45	20-186	43.5	82-242	30	89	63-230	M20	12	300	8600636
ACP-TURNADO 6.3 t M24	6.3	¹	154	23	23	66	60	24-210	55	104-280	36	121	79-265	M24	14	500	8600638
ACP-TURNADO 8 t M30	8	¹	183	29	27	75	75	30-271	68.5	129-359	46	148	98-340	M30	17	800	8600640

¹ Weight depends on the design.

Subject to technical changes!

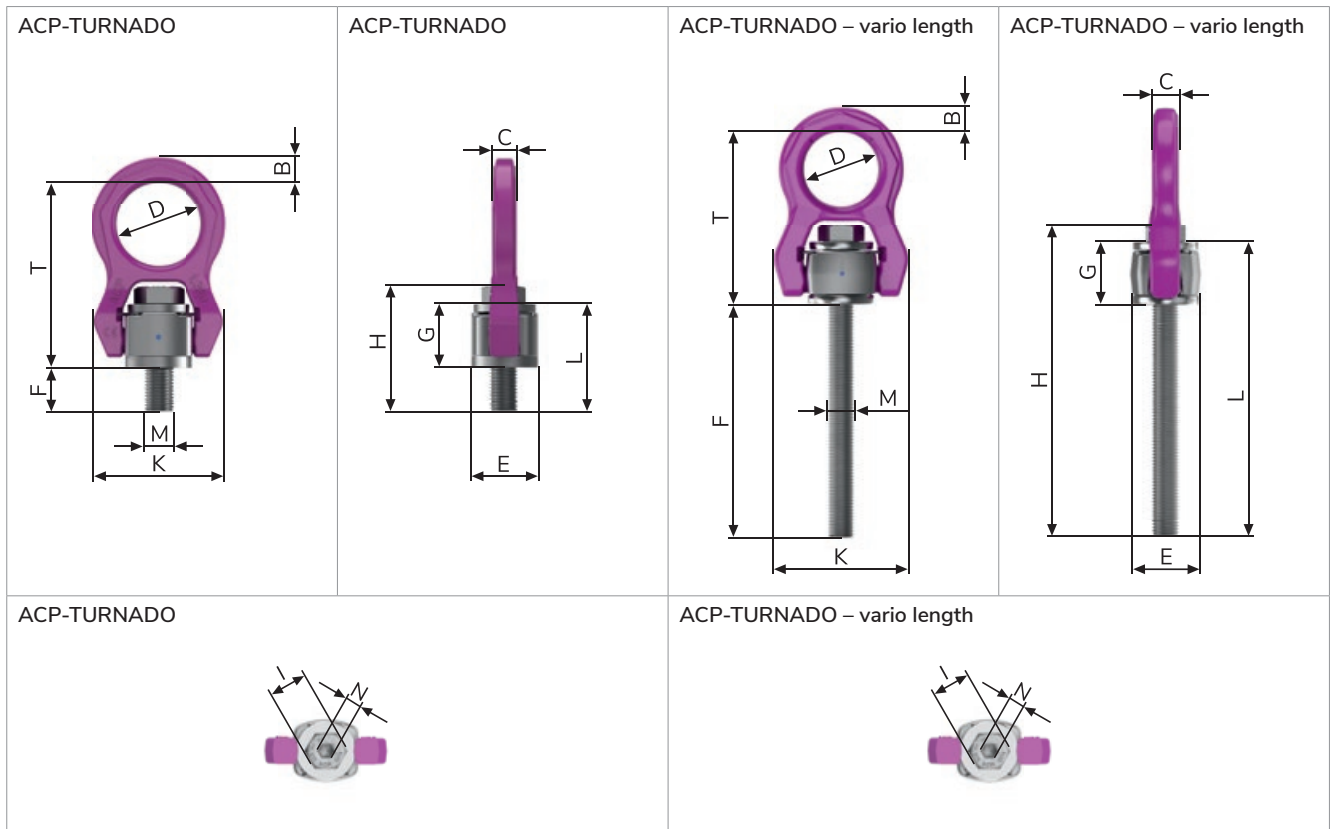

ACP-TURNADO

UNC inch thread / UNC inch thread in variable length.

ACP-TURNADO – UNC INCH THREAD.

Type	WLL [t]	Weight (kg/unit)	T [mm]	B [mm]	C [mm]	D [mm]	E [mm]	F [mm]	G [mm]	H [mm]	I	K [mm]	L [mm]	M	N	Tightening torque [Nm]	Ref. No.
ACP – 1.35t 1/2"-13UNC	1.35	0.39	83	11	10.5	38	30	18	28	54	3/4"	58	46	1/2"-13UNC	5/16"	80	7909417
ACP – 2.5t 5/8"-11UNC	2.5	0.88	107	14	14	50	40	22	36	68	15/16"	76	58	5/8"-11UNC	3/8"	150	7909418
ACP – 4t 3/4"-10UNC	4	1.41	118	17	17.25	50	45	25.5	43.5	81	1 1/8"	89	69	3/4"-10UNC	1/2"	300	7909419
ACP – 6.3t 1"-8UNC	6.3	3.22	154	23	23	66	60	36	55	105.5	1 1/2"	121	91	1"-8UNC	9/16"	500	7909420
ACP – 8t 1 1/4"-7UNC	8	5.77	183	29	27	75	75	46.5	68.5	135	1 7/8"	148	115	1 1/4"-7UNC	5/8"	800	7909421

Subject to technical changes!

ACP-TURNADO – UNC INCH THREAD IN VARIABLE LENGTH.

Type	WLL [t]	Weight (kg/unit)	T [mm]	B [mm]	C [mm]	D [mm]	E [mm]	F vario [mm]	G [mm]	H vario [mm]	I	K [mm]	L vario [mm]	M	N	Tightening torque [Nm]	Ref. No.
ACP – 1.35t 1/2"-13UNC	1.35	¹	83	11	10.5	38	30	18-124	28	54-160	3/4"	58	40-152	1/2"-13UNC	5/16"	80	8600632
ACP – 2.5t 5/8"-11UNC	2.5	¹	107	14	14	50	40	16-148	36	68-194	15/16"	76	52-184	5/8"-11UNC	3/8"	150	8600634
ACP – 4t 3/4"-10UNC	4	¹	118	17	17.25	50	45	20-185	43.5	81-240	1 1/8"	89	64-228	3/4"-10UNC	1/2"	300	8600636
ACP – 6.3t 1"-8UNC	6.3	¹	154	23	23	66	60	25-199	55	105.5-270	1 1/2"	121	80-254	1"-8UNC	9/16"	500	8600638
ACP – 8t 1 1/4"-7UNC	8	¹	183	29	27	75	75	32-271	68.5	135-359	1 7/8"	148	100-339	1 1/4"-7UNC	5/8"	800	8600640

¹ Weight depends on the design.

Subject to technical changes!

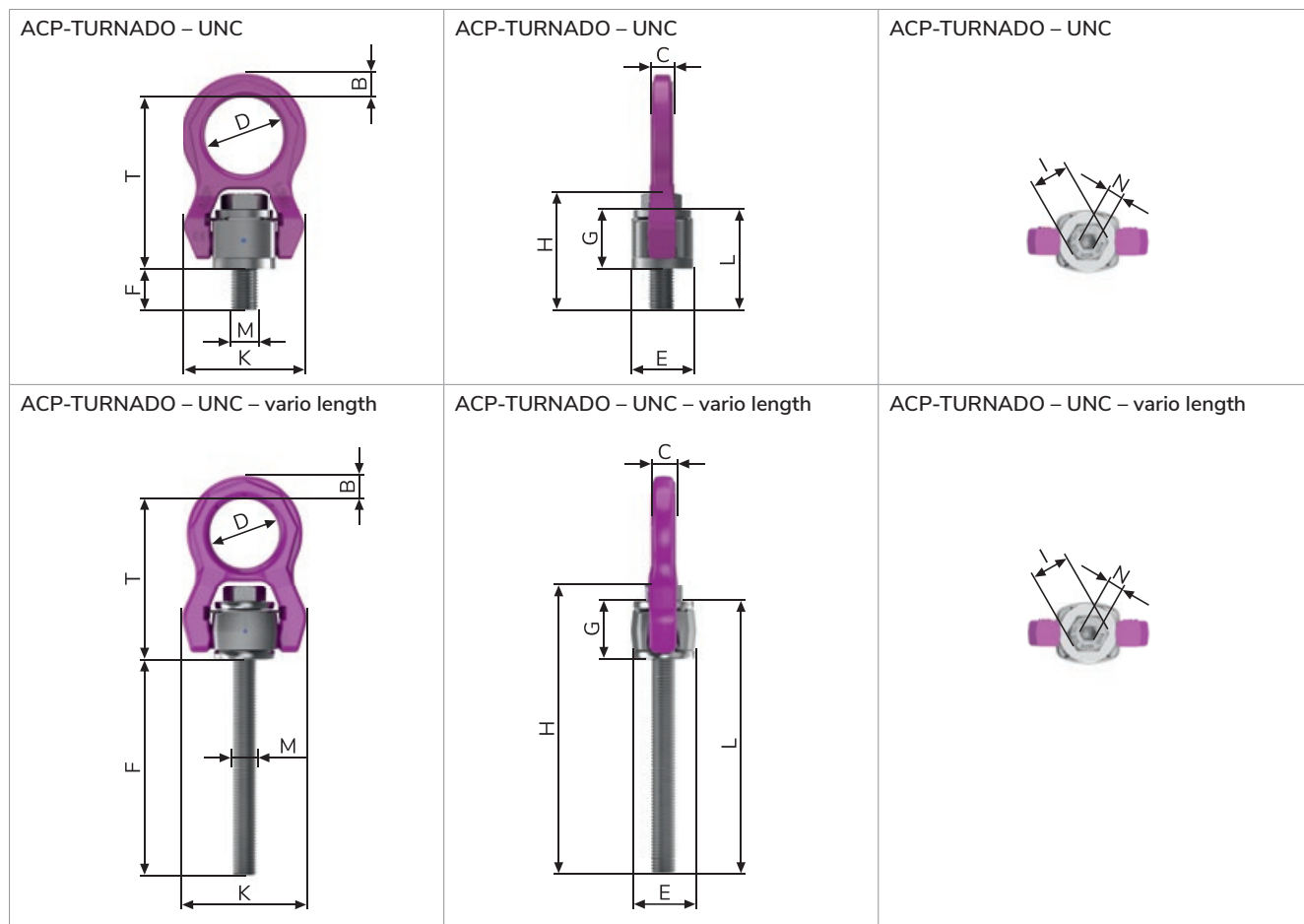

ACP-TURNADO

Automatic-Center-Point.

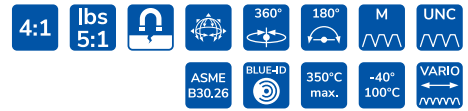

RUD RFID
CONNECT IT

NEW!
M36 + M42
1 1/2" + 1 3/4"



PRODUCT FEATURES

- No dangerous transverse loads – no worst case.
- No stopping of lift bale.
- Innovative internal spring mechanism – optimally protected.
- Deflector disc with angle marking, WLL information in "t" and "lbs", safety factors and torque moment. Fulfills the requirements of the American standard ASME B30.26.
- Combination head screw with internal and external hexagon for optimised handling.
- Swivel joint in the lifting ring axis.
- Free space for individual marking/stamp.
- Wear markings lenses for checking discard criteria.
- Embedded RFID transponder to make checks easier.

Innovative internal spring mechanism.



Swivel joint
in the lifting
ring axis.



Deflector disc with angle marking.



Combination head bolt with internal
and external hexagon socket M36, M42,
1 1/2" and 1 3/4".



Patented wear markings.



RFID connected
(as standard).

RUD RFID
CONNECT IT



For more information:
acp-turnado.com

COMING SOON:
M48–M100
2"–4"



ACP-TURNADO

Metric thread / UNC inch thread.

Metric thread and imperial thread in chosen length.

ACP-TURNADO – METRIC/INCH.

Type	WLL [t]	Weight (kg/unit)	A [mm]	B [mm]	C [mm]	D [mm]	E [mm]	F [mm]	G [mm]	H [mm]	J [mm]	K [mm]	L [mm]	M	N [mm]	T [mm]	Tightening torque [Nm]	Ref. No.
ACP-M36	12.5	7.1	106	32	32	82	70	45	60	128	55	168	105	M36	22	189	800	7911052
ACP-M42	16	7.5	106	32	32	82	70	53	60	136	65	168	113	M42	24	189	1,500	7911053
ACP 1 1/2"	14	7.3	106	32	32	82	70	48	60	131	2 1/4"	168	108	1 1/2"	7/8"	189	800	7911054
ACP 1 3/4"	16	7.5	104	32	32	82	70	56	60	141	2 5/8"	168	117	1 3/4"	1"	189	1,500	7911055

Subject to technical changes!

ACP-TURNADO – METRIC AND IMPERIAL THREAD IN CHOSEN LENGTH.

Type	WLL [t]	Weight (kg/unit)	A [mm]	B [mm]	C [mm]	D [mm]	E [mm]	F [mm]	G [mm]	H [mm]	J [mm]	K [mm]	L [mm]	M	N [mm]	T [mm]	Tightening torque [Nm]	Ref. No.
ACP-M36	12.5	¹	106	32	32	82	70	36-240	60	128-323	55	168	105-300	M36	22	189	800	8600642
ACP-M42	16	¹	106	32	32	82	70	42-290	60	136-373	65	168	113-350	M42	24	189	1,500	8600644
ACP-1 1/2"	14	¹	106	32	32	82	70	38-287	60	131-370	2 1/4"	168	108-347	1 1/2"	7/8"	189	800	8600643

¹ Weight depends on the design.

Subject to technical changes!

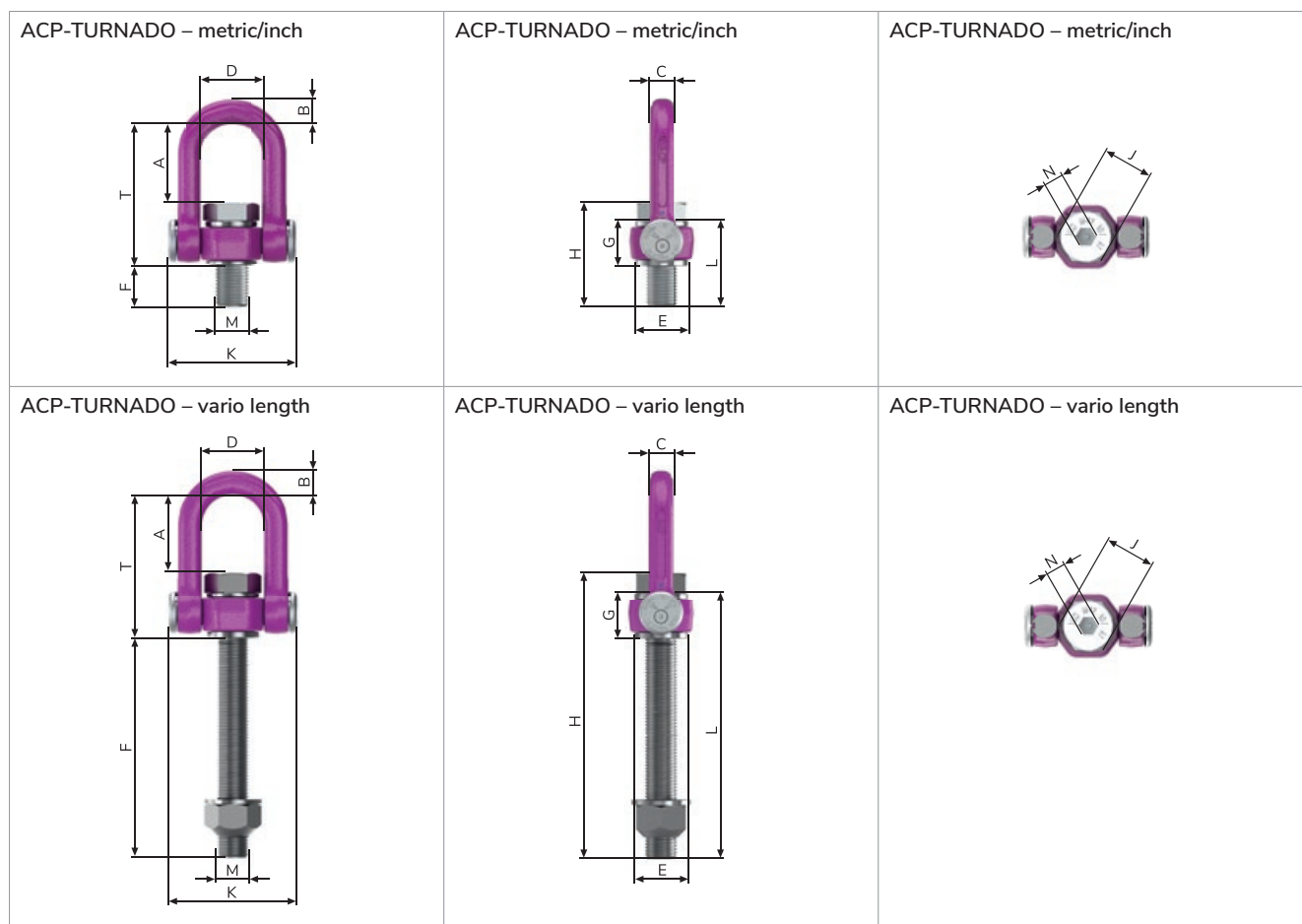



VLBG-PLUS

VIP-Load ring thread PLUS.



PRODUCT FEATURES

- Large WLL range 0.63 t–20 t.
- Captive but exchangeable ICE-Bolt made of patented steel up to size M24 with special corrosion protection Corrud-DT. Safe deep temperature usage; improved toughness meaning higher bending strength and lower wear occurrence.
- The clamping spring achieves noise reduction and keeps the suspension ring in the desired direction; thereby simple hinging of the lifting means is possible or a flat design in the folded state.
- DNVGL certification from size M30.

<p>RUD ICE-Bolt screw with combination head.</p>  	<p>360° rotatable, 180° pivotable.</p> 	 <p>Clear marking of the minimum WLL.</p>
<p>Clamping spring.</p> 	<p>Off centre split force introduction.</p> 	



✓ Tested and certified by DGUV.
 Test criteria: GS-HM-36:2021_09
 Certificate no.: HM220053

- Suspension ring adjustable in force direction.
- Comprehensive range of threads.

VLBG-PLUS / VLBG

Metric thread.

VLBG-PLUS-LOAD RING THREAD PLUS – METRIC.

Type	WLL [t]	Weight (kg/unit)	T [mm]	A [mm]	B [mm]	C [mm]	D [mm]	E [mm]	F [mm]	G [mm]	H [mm]	I [mm]	K [mm]	L [mm]	M	N [mm]	Tightening torque [Nm]	Ref. No.
VLBG-PLUS 0.63t M8	0.63	0.3	75	30	52	34	24	40	10	29	11	75	45	40	M8	32	30	8504651
VLBG-PLUS 0.9t M10	0.9	0.32	75	30	54	34	24	39	10	29	15	75	45	44	M10	32	60	8504652
VLBG-PLUS 1.35t M12	1.35	0.33	75	32	54	34	26	38	10	29	18	75	45	47	M12	32	150	8504653
VLBG-PLUS 2t M16	2	0.55	85	33	56	36	30	39	13.5	36	22	86	47	58	M16	38	150	8504655
VLBG-PLUS 3.5t M20	3.5	1.3	110	50	82	54	45	55	16.5	43	32	113	64	75	M20	48	400	8504657
VLBG-PLUS 4.5t M24	4.5	1.5	125	50	82	54	45	67	18	43	37	130	78	80	M24	48	760	8504659
VLBG-PLUS 6.7t M30	6.7	3.3	147	60	103	65	60	67	22.5	61	49	151	80	110	M30	67	1.000	8504661
VLBG-PLUS 7t M36 (So-bolt)	7	3.4	146	60	103	65	60	74	22.5	55	52	151	80	107	M36	67	700	8500829
VLBG-PLUS 8t M36	8	6.2	196	77	122	82	70	97	26.5	77	63	205	113	140	M36	79	800	7983553
VLBG-PLUS 10t M42	10	6.7	196	77	122	82	70	94	26.5	77	73	205	113	150	M42	79	1.000	7983554
VLBG-PLUS 15t M42	15	10.9	222	95	156	100	85	109	36	87	63	230	130	150	M42	100	1.500	7982966
VLBG-PLUS 20t M48	20	11.6	222	95	156	100	95	105	36	87	73	230	130	160	M48	100	2.000	7982967

Subject to technical changes!

VLBG-LOAD RING THREAD – METRIC INTERMEDIATE SIZES IN VARIABLE LENGTH.

Type	WLL [t]	Weight (kg/unit)	T [mm]	A [mm]	B [mm]	C [mm]	D [mm]	E [mm]	F [mm]	G [mm]	H vario [mm]	I [mm]	K [mm]	L vario [mm]	M	N	Tightening torque [Nm]	Ref. No.
VLBG 1.2t M14	1.2	¹	85	33	56	36	30	39	13.5	36	14-129	86	47	50-165	M14	38	120	8600399
VLBG 2t M18	2	¹	110	50	82	54	45	55	16.5	43	18-27	113	64	61-70	M18	48	200	8600384
VLBG 2.5t M22	2.5	¹	110	50	82	54	45	54	16.5	43	22-57	113	64	65-100	M22	48	250	8600385
VLBG 4t M27	4	¹	147	60	103	65	60	59	22.5	61	27-239	151	80	88-300	M27	67	400	8600387

¹ Weight depends on the design.

Subject to technical changes!

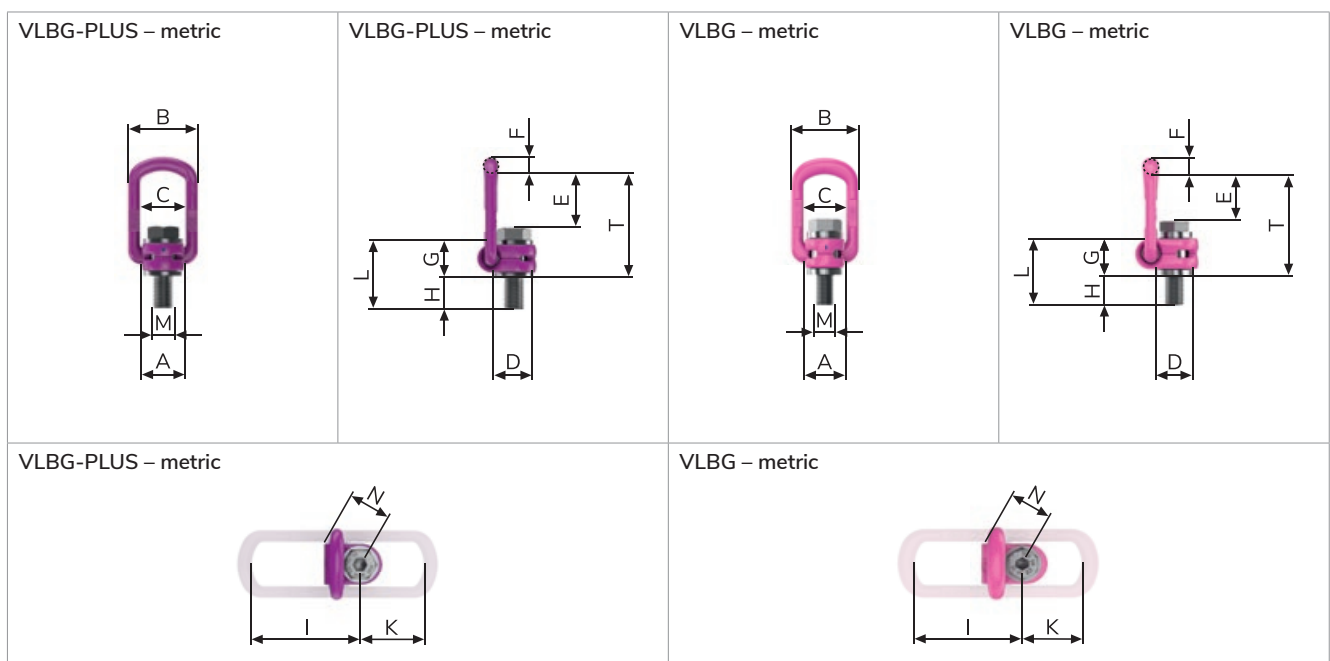

VLBG-PLUS / VLBG

Metric chosen length /
metric fine thread in variable length.

VLBG-PLUS-LOAD RING THREAD PLUS – METRIC IN VARIABLE LENGTH.

Type	WLL [t]	Weight (kg/unit)	T [mm]	A [mm]	B [mm]	C [mm]	D [mm]	E [mm]	F [mm]	G [mm]	H vario [mm]	I [mm]	K [mm]	L vario [mm]	M	N [mm]	Tightening torque [Nm]	Ref. No.
VLBG-PLUS 0.63t M8	0.63	¹	75	30	54	34	24	40	10	29	8-76	75	45	37-105	M8	32	30	8600470
VLBG-PLUS 0.9t M10	0.9	¹	75	30	54	34	24	39	10	29	10-96	75	45	39-125	M10	32	60	8600471
VLBG-PLUS 1.35t M12	1.35	¹	75	32	54	34	26	38	10	29	12-116	75	45	41-145	M12	32	150	8600472
VLBG-PLUS 2t M16	2	¹	85	33	56	36	30	39	13.5	36	16-149	86	47	52-185	M16	38	150	8600474
VLBG-PLUS 3.5t M20	3.5	¹	110	50	82	54	45	55	16.5	43	20-187	113	64	63-230	M20	48	400	8600476
VLBG-PLUS 4.5t M24	4.5	¹	125	50	82	54	45	67	18	43	24-222	130	78	67-265	M24	48	760	8600478
VLBG-PLUS 6.7t M30	6.7	¹	147	60	103	65	60	67	22.5	61	30-279	151	80	91-340	M30	67	1.000	8600480
VLBG-PLUS 8t M36	8	¹	197	77	122	82	70	97	26.5	77	36-223	205	110	113-300	M36	87	800	8600289
VLBG-PLUS 10t M42	10	¹	197	77	122	82	70	94	26.5	77	42-273	205	110	119-350	M42	70	1.000	8600290
VLBG-PLUS 15t M42	15	¹	222	95	156	100	85	109	36	87	42-263	230	130	129-350	M42	100	1.500	8600291
VLBG-PLUS 20t M48	20	¹	222	95	156	100	95	105	36	87	48-303	230	130	135-350	M48	100	2.000	8600292

¹ Weight depends on the design.

Subject to technical changes!

VWBG-V LOAD RING – METRIC FINE THREAD IN VARIABLE LENGTH.

Type	WLL [t]	Weight (kg/unit)	T [mm]	A [mm]	B [mm]	C [mm]	D [mm]	E [mm]	F [mm]	G [mm]	H vario [mm]	I [mm]	K [mm]	L vario [mm]	M	N [mm]	Tightening torque [Nm]	Ref. No.
VLBG 1t M12 x 1.5	1	¹	75	32	54	34	26	38	10	29	12-31	75	45	41-60	M12 x 1.5	32	100	8600382
VLBG 1.2t M14 x 1.5	1.2	¹	85	33	56	36	30	39	13.5	36	14-34	86	47	50-70	M14 x 1.5	38	120	8600399
VLBG 1.5t M16 x 1.5	1.5	¹	85	33	56	36	30	39	13.5	36	16-39	86	47	52-75	M16 x 1.5	38	150	8600383
VLBG 2t M18 x 1.5	2	¹	110	50	82	54	45	55	16.5	43	18-47	113	64	61-90	M18 x 1.5	48	200	8600384
VLBG 2.5t M20 x 1.5	2.5	¹	110	50	82	54	45	55	16.5	43	20-52	113	64	63-95	M20 x 1.5	48	250	8600385
VLBG 4t M24 x 1.5	4	¹	125	50	82	54	45	67	18	43	24-62	130	78	67-105	M24 x 1.5	48	400	8600386
VLBG 5t M30 x 2	5	¹	147	60	103	65	60	67	22.5	61	30-74	151	80	91-135	M30 x 2	67	500	8600388

¹ Weight depends on the design.

Subject to technical changes!

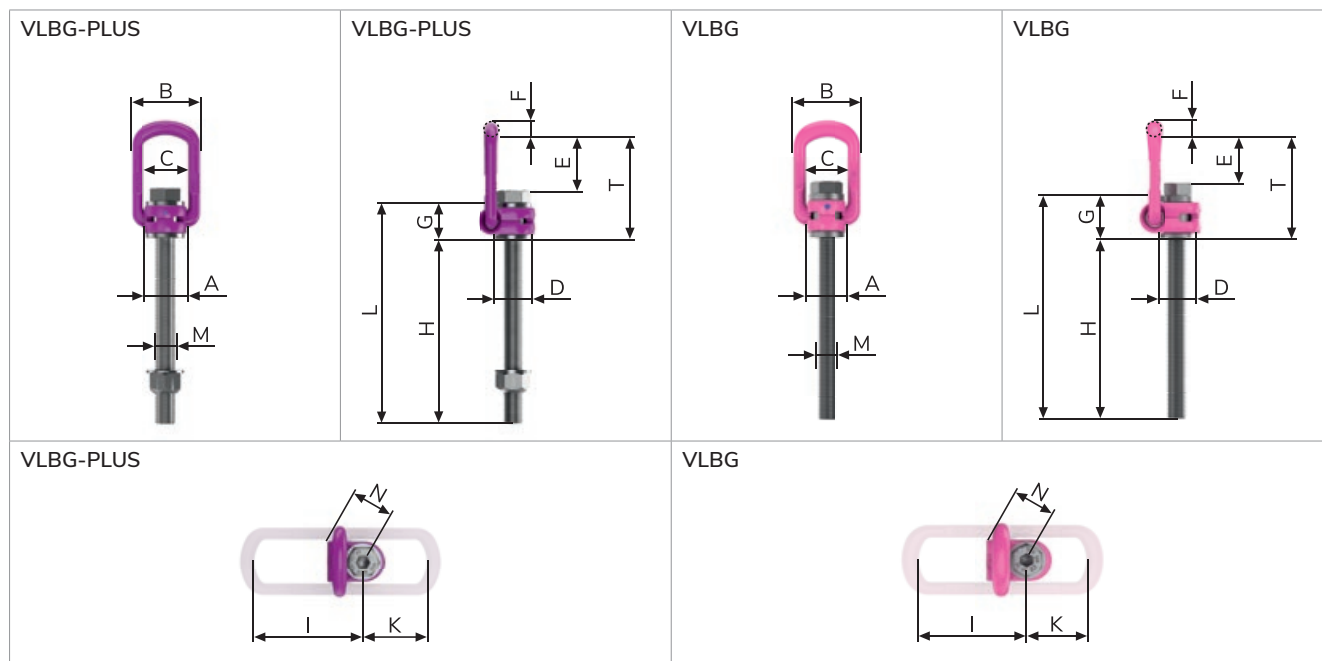

VLBG-Z

UNC inch thread /
UNC inch thread in variable length.

VLBG-Z-LOAD RING THREAD – UNC INCH THREAD.

Type	WLL [t]	Weight (kg/unit)	T [mm]	A [mm]	B [mm]	C [mm]	D [mm]	E [mm]	F [mm]	G [mm]	H [mm]	I [mm]	K [mm]	L [mm]	M	N [mm]	Tightening torque [Nm]	Ref. No.
VLBG-Z 0.63t 3/8"-16UNC	0.63	0.29	75	30	54	34	24	39	10	29	16	75	45	45	3/8"-16UNC	32	60	8504256
VLBG-Z 1t 1/2"-13UNC	1	0.36	75	32	54	34	26	38	10	29	22	75	45	50	1/2"-13UNC	32	100	8502349
VLBG-Z 1.5t 5/8"-11UNC	1.5	0.5	85	33	56	36	30	39	13.5	36	24	86	47	60	5/8"-11UNC	38	150	8502350
VLBG-Z 2.5t 3/4"-10UNC	2.5	1.3	110	50	82	54	45	55	16.5	43	28	113	64	71	3/4"-10UNC	48	250	8502351
VLBG-Z 2.5t 7/8"-9UNC	2.5	1.25	110	50	82	54	45	55	16.5	43	27	113	64	70	7/8"-9UNC	48	250	8502352
VLBG-Z 4t 1"-8UNC	4	1.5	125	50	82	54	45	67	18	43	41	130	78	84	1"-8UNC	48	400	8502353
VLBG-Z 5t 1 1/4"-7UNC	5	3.33	147	60	103	65	60	64	22.5	61	41	151	80	102	1 1/4"-7UNC	67	500	8503187
VLBG-Z 5t 1 1/4"-8UN	5	3.33	147	60	103	65	60	64	22.5	61	41	151	80	102	1 1/4"-8UN	67	500	8502354
VLBG-Z 8t 1 1/2"-6UNC	8	6.2	197	77	122	82	70	97	26.5	77	62	205	110	140	1 1/2"-6UNC	87	800	8504257
VLBG-Z 20t 2"-4.5UNC	20	11.7	222	95	156	100	95	105	36	87	69	230	130	156	2"-4.5UNC	100	2.000	8504258

Subject to technical changes!

VLBG-Z LOAD RING THREAD – UNC INCH THREAD IN VARIABLE LENGTH.

Type	WLL [t]	Weight (kg/unit)	T [mm]	A [mm]	B [mm]	C [mm]	D [mm]	E [mm]	F [mm]	G [mm]	H vario [mm]	I [mm]	K [mm]	L vario [mm]	M	N [mm]	Tightening torque [Nm]	Ref. No.
VLBG-Z 0.63t 3/8"-16UNC	0.63	¹	75	30	54	34	24	39	10	29	10-98	75	45	39-127	3/8"-16UNC	32	60	8600440
VLBG-Z 1t 1/2"-13UNC	1	¹	75	32	54	34	26	38	10	29	13-123	75	45	42-152	1/2"-13UNC	32	100	8600441
VLBG-Z 1.5t 5/8"-11UNC	1.5	¹	85	33	56	36	30	39	13.5	36	16-148	86	47	52-184	5/8"-11UNC	38	150	8600442
VLBG-Z 2.5t 3/4"-10UNC	2.5	¹	110	50	82	54	45	55	16.5	43	19-185	113	64	62-228	3/4"-10UNC	48	250	8600443
VLBG-Z 2.5t 7/8"-9UNC	2.5	¹	110	50	82	54	45	55	16.5	43	22-211	113	64	65-254	7/8"-9UNC	48	250	8600444
VLBG-Z 4t 1"-8UNC	4	¹	125	50	82	54	45	67	18	43	25-211	130	78	68-254	1"-8UNC	48	400	8600445
VLBG-Z 5t 1 1/4"-7UNC	5	¹	147	60	103	65	60	64	22.5	61	32-278	151	80	93-339	1 1/4"-7UNC	67	500	8600446
VLBG-Z 8t 1 1/2"-6UNC	8	¹	197	77	122	82	70	97	26.5	77	38-270	205	110	115-347	1 1/2"-6UNC	87	800	8600447
VLBG-Z 20t 2"-4.5UNC	20	¹	222	95	156	100	95	105	36	87	51-302	230	130	138-389	2"-4.5UNC	100	2.000	8600448

¹ Weight depends on the design.

Subject to technical changes!

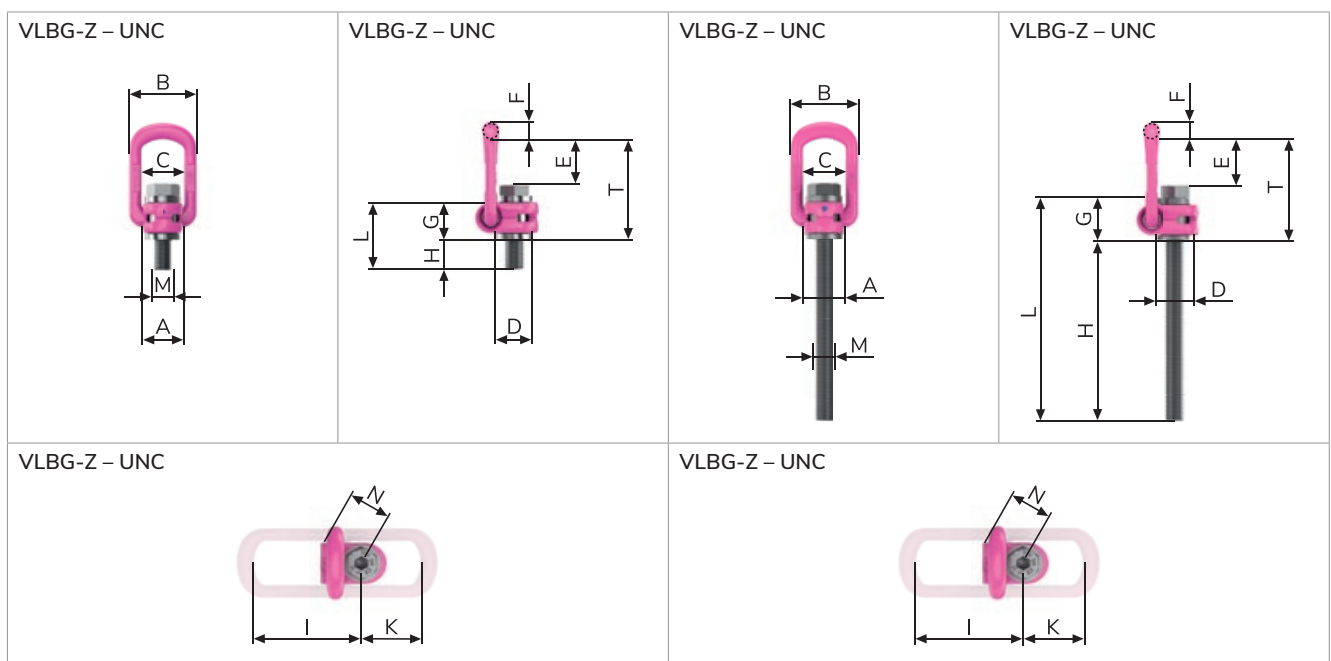

PP-S / PP-B / PP-VIP

PowerPoint®-Star / -eye connection /
-VIP-chain connection.



PRODUCT FEATURES

- Large WLL range 0.63 t–8 t.
- PP-S: universal connection with hook for ring suspensions, round slings, wire ropes, hook suspensions.
- PP-B: eye connection for hook suspension.
- PP-VIP: direct chain connection.
- So-PP-S, So-PP-B, So-PP-VIP: variable thread lengths.
- Rotatable 90° to the bolt-on direction under WLL.
- Lowest kinking possibility due to cardan joint.
- PP-VIP, So-PP-VIP: universal and non-mix-up clevis connection for easy construction with chains, hooks and eye.
- PP-S, So-PP-S: The shape of the hook tip prevents hinging in small openings and the WLL on the hook tip.
- PP-S: Robust forged safety latch.

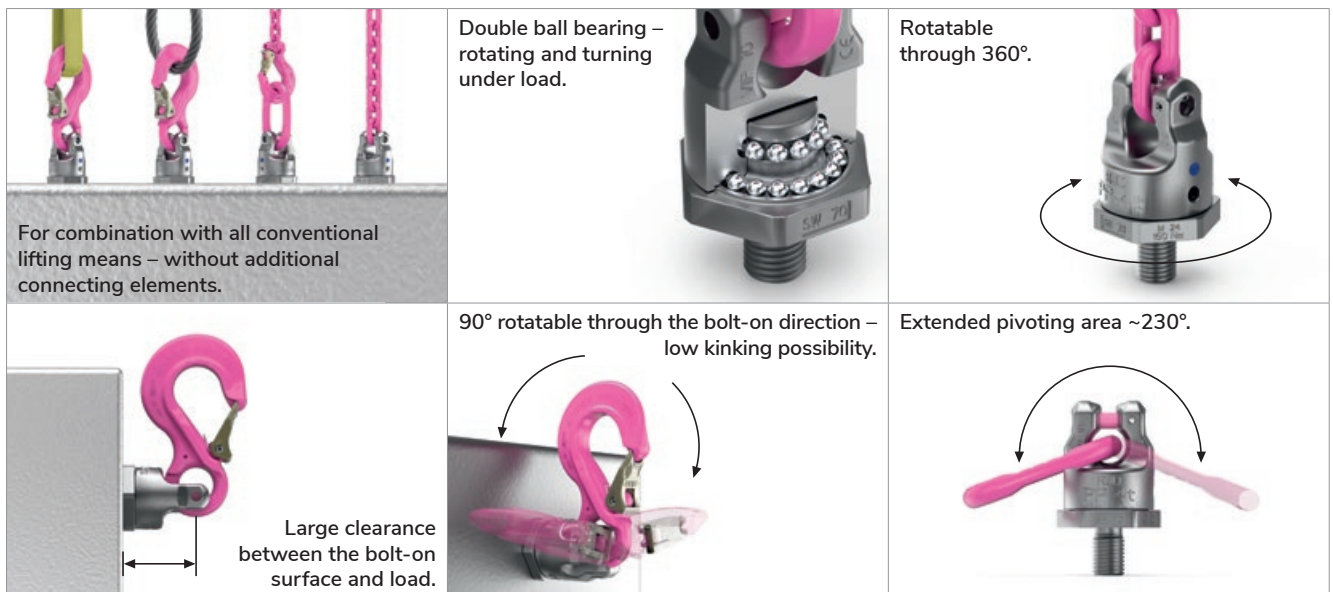

✓ Tested and certified by DGUV.
Test criteria: GS-OA-15-04: 2015-12
Certificate no.: OA 1951040

- 360° rotatable, 230° pivotable.
- Double ball bearing for tilting, rotating and turning under load.
- Universal, non-mix-up VIP connection for chains, hooks and eyes.

PP-S / PP-B / PP-VIP

Metric thread.

PP-S – POWERPOINT – STAR UNIVERSAL CONNECTION – METRIC.

Type	WLL [t]	Weight (kg/unit)	T [mm]	A [mm]	B [mm]	C [mm]	D [mm]	E [mm]	F [mm]	G [mm]	M	N [mm]	Tightening torque [Nm]	Ref. No.
PP-S-0.63t-M12	0.63	0.4	116	13	75	18	40	36	18	41	M12	-	10	7990719
PP-S-1.5t-M16	1.5	0.9	146	20	97	25	46	41	24	50	M16	-	30	7989719
PP-S-2.5t-M20	2.5	1.7	187	28	126	30	61	55	30	61	M20	-	70	7989075
PP-S-4t-M24	4	3.5	227	36	150	35	78	70	36	77	M24	-	150	7989076
PP-S-5t-M30	5 (6.7) ¹	7.5	267	37	174	40	95	85	45	93	M30	-	225	7989720
PP-S-8t-M36	8 (10) ¹	9.2	310	49	208	48	100	90	54	102	M36	-	410	7989077

¹ () = Higher WLL with axial load.

Subject to technical changes!

PP-B – POWERPOINT – EYE CONNECTION – METRIC.

Type	WLL [t]	Weight (kg/unit)	T [mm]	A [mm]	B [mm]	C [mm]	D [mm]	E [mm]	F [mm]	G [mm]	M	N [mm]	Tightening torque [Nm]	Ref. No.
PP-B-0.63t-M12	0.63	0.35	106	9	65	35	40	36	18	41	M12	15	10	7989522
PP-B-1.5t-M16	1.5	0.6	115	11	65	35	46	41	24	49	M16	15	30	7989523
PP-B-2.5t-M20	2.5	1.1	136	13	75	40	61	55	30	61	M20	18	70	7989081
PP-B-4t-M24	4	2.4	172	16	95	45	78	70	36	77	M24	20	150	7989082
PP-B-5t-M30	5 (6.7) ¹	5.2	223	21	130	60	95	85	45	93	M30	25	225	7989524
PP-B-8t-M36	8 (10) ¹	6.3	242	24	140	65	100	90	54	102	M36	28	410	7989083

¹ () = Higher WLL with axial load.

Subject to technical changes!

PP-VIP – POWERPOINT – DIRECT VIP-CHAIN CONNECTION – METRIC.

Type	WLL [t]	Weight (kg/unit)	T [mm]	A [mm]	B [mm]	C [mm]	D [mm]	E [mm]	F [mm]	G [mm]	M	N [mm]	Tightening torque [Nm]	Ref. No.
PP-VIP4-0.63t-M12	0.63	0.25	41	4	-	-	40	36	18	-	M12	-	10	7989525
PP-VIP6-1.5t-M16	1.5	0.45	49	6	-	-	46	41	24	-	M16	-	30	7989526
PP-VIP8-2.5t-M20	2.5	0.95	61	8	-	-	61	55	30	-	M20	-	70	7989527
PP-VIP10-4t-M24	4	2.2	77	10	-	-	78	70	36	-	M24	-	150	7989528
PP-VIP13-5t-M30	5 (6.7) ¹	3.5	93	13	-	-	95	85	45	-	M30	-	225	7989529
PP-VIP16-8t-M36	8 (10) ¹	4.7	102	16	-	-	100	90	54	-	M36	-	410	7989530

¹ () = Higher WLL with axial load.

Subject to technical changes!

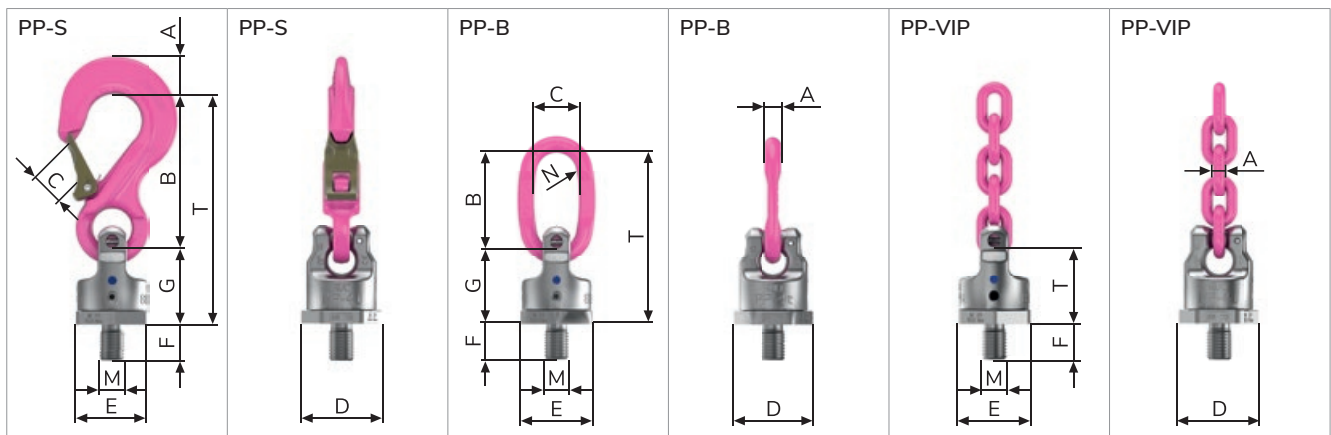

PP-S / PP-B / PP-VIP

UNC inch thread.

PP-S – POWERPOINT – STAR UNIVERSAL CONNECTION – UNC INCH THREAD.

Type	WLL [t]	Weight (kg/unit)	T [mm]	A [mm]	B [mm]	C [mm]	D [mm]	E [mm]	F [mm]	G [mm]	M	N [mm]	Tightening torque [Nm]	Ref. No.
PP-S-0.63t-1/2"-13UNC	0.63	0.4	116	13	75	18	40	36	18	41	1/2"-13UNC	-	10	8600581
PP-S-1.5t-5/8"-11UNC	1.5	0.9	146	20	97	25	46	41	25	49	5/8"-11UNC	-	30	8600582
PP-S-2.5t-3/4"-10UNC	2.5	1.7	187	28	126	30	61	55	30	61	3/4"-10UNC	-	70	8600583
PP-S-2.5t-7/8"-9UNC	2.5	1.7	187	28	126	30	61	55	30	61	7/8"-9UNC	-	70	8600583
PP-S-4t-1"-8UNC	4	3.5	227	36	150	35	78	70	36	77	1"-8UNC	-	150	8600584
PP-S-5t-1 1/4"-7UNC	5 (6.7) ¹	7.5	267	37	174	40	95	85	45	93	1 1/4"-7UNC	-	225	8600585
PP-S-8t-1 1/2"-6UNC	8 (10) ¹	9.2	310	49	208	48	100	90	54	102	1 1/2"-6UNC	-	410	8600526

¹ () = Higher WLL with axial load.

Subject to technical changes!

PP-B – POWERPOINT – EYE CONNECTION – UNC INCH THREAD.

Type	WLL [t]	Weight (kg/unit)	T [mm]	A [mm]	B [mm]	C [mm]	D [mm]	E [mm]	F [mm]	G [mm]	M	N [mm]	Tightening torque [Nm]	Ref. No.
PP-B-0.63t-1/2"-13UNC	0.63	0.35	106	9	65	35	40	36	18	41	1/2"-13UNC	15	10	8600591
PP-B-1.5t-5/8"-11UNC	1.5	0.6	115	11	65	35	46	41	24	50	5/8"-11UNC	15	30	8600592
PP-B-2.5t-3/4"-10UNC	2.5	1.1	136	13	75	40	61	55	30	61	3/4"-10UNC	18	70	8600593
PP-B-2.5t-7/8"-9UNC	2.5	1.1	136	13	75	40	61	55	30	61	7/8"-9UNC	18	70	8600593
PP-B-4t-1"-8UNC	4	2.4	172	16	95	45	78	70	36	77	1"-8UNC	20	150	8600594
PP-B-5t-1 1/4"-7UNC	5 (6.7) ¹	5.2	223	21	130	60	95	85	45	93	1 1/4"-7UNC	25	225	8600595
PP-B-8t-1 1/2"-6UNC	8 (10) ¹	6.3	242	24	140	65	100	90	54	102	1 1/2"-6UNC	28	410	8600566

¹ () = Higher WLL with axial load.

Subject to technical changes!

PP-VIP – POWERPOINT – DIRECT VIP-CHAIN CONNECTION – UNC INCH THREAD.

Type	WLL [t]	Weight (kg/unit)	T [mm]	A [mm]	B [mm]	C [mm]	D [mm]	E [mm]	F [mm]	G [mm]	M	N [mm]	Tightening torque [Nm]	Ref. No.
PP-VIP4-0.63t-1/2"-13UNC	0.63	0.25	41	4	-	-	40	36	18	-	1/2"-13UNC	-	10	8600571
PP-VIP6-1.5t-5/8"-11UNC	1.5	0.45	49	6	-	-	46	41	24	-	5/8"-11UNC	-	30	8600572
PP-VIP8-2.5t-3/4"-10UNC	2.5	0.95	61	8	-	-	61	55	30	-	3/4"-10UNC	-	70	8600573
PP-VIP8-2.5t-7/8"-9UNC	2.5	1	61	8	-	-	61	55	30	-	7/8"-9UNC	-	70	8600573
PP-VIP10-4t-1"-8UNC	4	2.2	77	10	-	-	78	70	36	-	1"-8UNC	-	150	8600574
PP-VIP13-5t-1 1/4"-7UNC	5 (6.7) ¹	3.5	93	13	-	-	95	85	45	-	1 1/4"-7UNC	-	225	8600575
PP-VIP16-8t-1 1/2"-6UNC	8 (10) ¹	4.7	102	16	-	-	100	90	54	-	1 1/2"-6UNC	-	410	8600305

¹ () = Higher WLL with axial load.

Subject to technical changes!

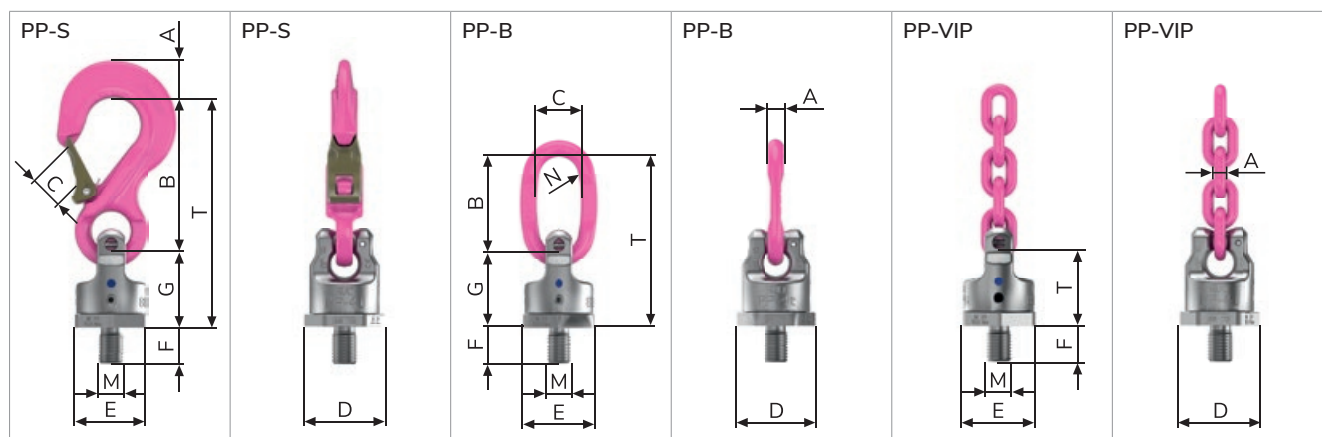

Other thread dimensions/thread types (e.g. UNF, BSW, pipe thread ...) available on request.

VCÖH / VIP-OVAL LINK

VIP-Cobra-eye hooks / VIP-Oval link.

VCÖH – VIP-COBRA-EYE HOOKS FOR POWERPOINT.

Type	WLL [t]	Weight (kg/unit)	T [mm]	A [mm]	B [mm]	C [mm]	D [mm]	E [mm]	F [mm]	G [mm]	H [mm]	M	Ref. No.
VCÖH 4	0.63	0.14	75	18	18	12	13	14	18	52	8	M12 / 1/2"-13UNC	8502323
VCÖH 6	1.5	0.5	97	24	20	16	22	24	25	73	11	M16 / 5/8"-11UNC	8502203
VCÖH 8	2.5	0.8	126	32	28	20	28	31	30	95	13	M20 / 3/4"-10UNC / 7/8"-9UNC	8502142
VCÖH 10	4	1.58	150	38	36	26	36	39	35	118	17	M24 / 1"-8UNC	8502145
VCÖH 13	6.7	2.9	174	48	45	30	37	48	40	135	21	M30 / 1 1/4"-7UNC	8502204
VCÖH 16	10	4.2	208	63	56	36	49	58	48	161	27	M36 / 1 1/2"-6UNC	8502146

Subject to technical changes!

VIP-OVAL LINK FOR POWERPOINT.

Type	WLL [t]	Weight (kg/unit)	T [mm]	A [mm]	C [mm]	D [mm]	M	N [mm]	Ref. No.
PP 0.63t-B	0.63	0.1	65	9	35	4	M12 / 1/2"-13UNC	15	7989531
PP 1.5t-B	1.5	0.13	65	11	35	6	M16 / 5/8"-11UNC	15	8502173
PP 2.5t-B	2.5	0.22	75	13	40	8	M20 / 3/4"-10UNC / 7/8"-9UNC	18	8502174
PP 4t-B	4	0.42	95	16	45	10	M24 / 1"-8UNC	20	8502175
PP-VIP13-B	6.7	1	130	21	60	13	M30 / 1 1/4"-7UNC	25	8502176
PP-VIP16-B	10	1.4	140	24	65	16	M36 / 1 1/2"-6UNC	28	8502177

Subject to technical changes!

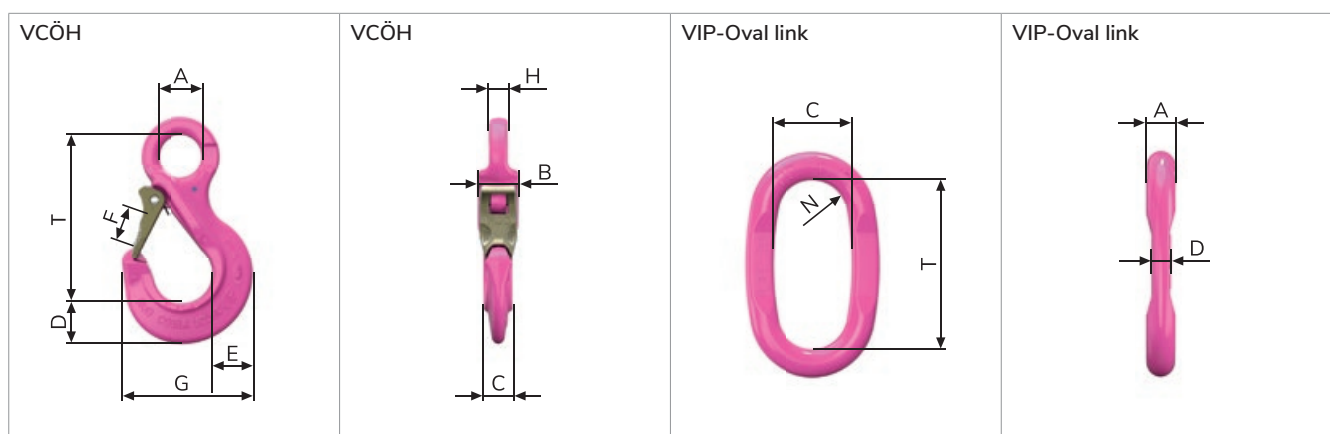

SO-PP-VIP

Metric thread / metric fine thread.

SO-PP-VIP¹ – SPECIAL POWERPOINT – VIP-CHAIN CONNECTION – METRIC IN VARIABLE LENGTH.

Type	WLL [t]	Weight (kg/unit)	T [mm]	A [mm]	D [mm]	E [mm]	F vario [mm]	M	Tightening torque [Nm]	Ref. No.
So-PP-VIP4-0.6t-M12	0.6 (0.63) ²	³	47	4	42	36	12-140	M12	10	8600320
So-PP-VIP6-1t-M14	1 (1.5) ²	³	58	6	48	41	14-160	M14	25	8600326
So-PP-VIP6-1.3t-M16	1.3 (1.5) ²	³	58	6	48	41	16-180	M16	30	8600321
So-PP-VIP8-2t-M20	2 (2.5) ²	³	73	8	61	55	20-224	M20	70	8600322
So-PP-VIP8-2t-M22	2 (2.5) ²	³	73	8	61	55	22-94	M22	70	8600322
So-PP-VIP10-3.5t-M24	3.5 (4) ²	³	94	10	81	70	24-255	M24	150	8600323
So-PP-VIP10-3.5t-M27	3.5 (4) ²	³	94	10	81	70	27-92	M27	200	8600323
So-PP-VIP13-5t-M30	5 (6.7) ²	³	108	13	99	85	30-330	M30	225	8600324
So-PP-VIP16-8t-M36	8 (10) ²	³	100	16	100	90	36-300	M36	410	8600305
So-PP-VIP16-8t-M39	8 (10) ²	³	100	16	100	90	39-300	M39	410	8600305
So-PP-VIP16-8t-M42	8 (10) ²	³	100	16	100	90	42-300	M42	410	8600305

¹ So-PP can also be installed with eye hook as So-PP-S or with link as So-PP-B.

² () = Higher WLL with axial load.

³ Weight depends on the design.

Subject to technical changes!

SO-PP-VIP¹ – SPECIAL POWERPOINT – VIP-CHAIN CONNECTION – METRIC FINE THREAD IN VARIABLE LENGTH.

Type	WLL [t]	Weight (kg/unit)	T [mm]	A [mm]	D [mm]	E [mm]	F vario [mm]	M	Tightening torque [Nm]	Ref. No.
So-PP-VIP4-0.6t-M12 × 1.5	0.6 (0.63) ²	³	47	4	42	36	12-55	M12 × 1.5	10	8600320
So-PP-VIP6-1t-M14 × 1.5	1 (1.5) ²	³	58	6	48	41	14-65	M14 × 1.5	25	8600326
So-PP-VIP6-1.3t-M16 × 1.5	1.3 (1.5) ²	³	58	6	48	41	16-70	M16 × 1.5	30	8600321
So-PP-VIP8-2t-M20 × 1.5	2 (2.5) ²	³	73	8	61	55	20-89	M20 × 1.5	70	8600322
So-PP-VIP10-3.5t-M24 × 1.5	3.5 (4) ²	³	94	10	81	70	24-95	M24 × 1.5	150	8600323
So-PP-VIP13-5t-M30 × 2	5 (6.7) ²	³	108	13	99	85	30-125	M30 × 2	225	8600324

¹ So-PP can also be installed with eye hook as So-PP-S or with link as So-PP-B.

² () = Higher WLL with axial load.

³ Weight depends on the design.

Subject to technical changes!

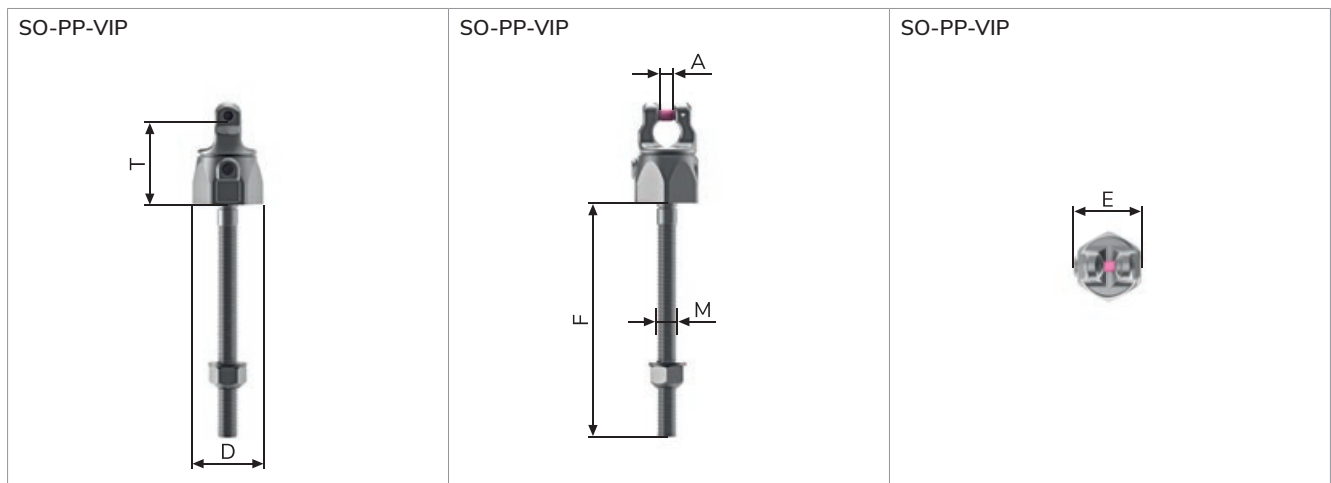

VWBG-KA / SO-PP-VIP-UNC

Direct VIP-chain connection / UNC inch thread.

VWBG-KA DIRECT VIP-CHAIN CONNECTION – METRIC / UNC INCH THREAD.

Type	WLL [t]	Weight (kg/unit)	T [mm]	A [mm]	D [mm]	E [mm]	F vario [mm]	M	Tightening torque [Nm]	Ref. No.
VWBG-KA-28 ¹	31.5	26.4	146	–	170	145	108	M72	1.200	7903437
So-VWBG-KA-28 ¹	31.5	³	146	–	170	145	72–300	M72–M76	1.200	8600239
So-VWBG-KA-28 ¹	31.5	³	146	–	170	145	72–300	3"-4UNC	1.200	8600239

¹ Pivoting area 180°.

³ Weight depends on the design.

Subject to technical changes!

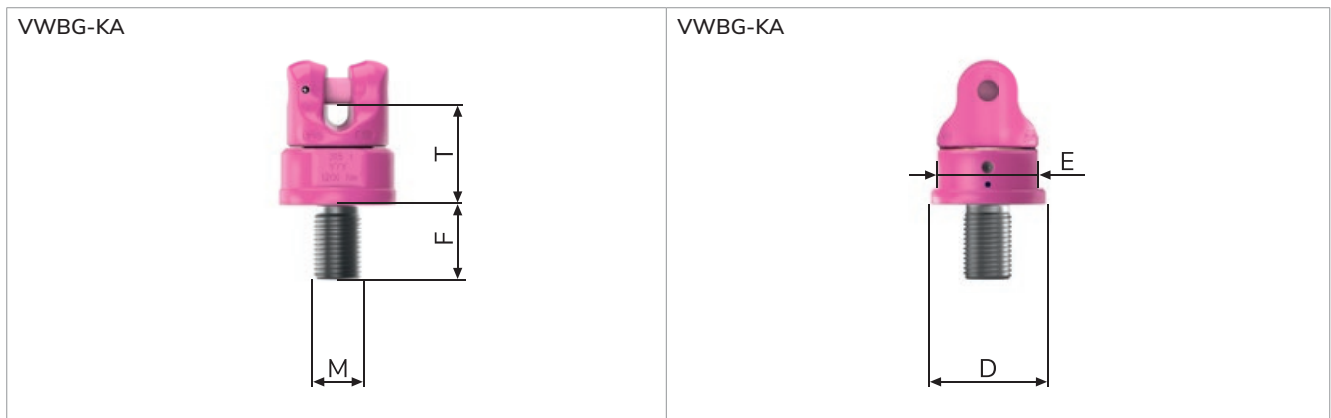

SO-PP-VIP-UNC¹ – SPECIAL POWERPOINT – VIP-CHAIN CONNECTION – UNC INCH THREAD IN VARIABLE LENGTH.

Type	WLL [t]	Weight (kg/unit)	T [mm]	A [mm]	D [mm]	E [mm]	F vario [mm]	M	Tightening torque [Nm]	Ref. No.
So-PP-VIP4-0.6 t-1/2"-13UNC	0.6 (0.63) ²	³	47	4	42	36	40–149	1/2"-13UNC	10	8600320
So-PP-VIP6-1 t-5/8"-11UNC	1 (1.5) ²	³	58	6	48	41	50–180	5/8"-11UNC	25	8600321
So-PP-VIP8-2 t-3/4"-10UNC	2 (2.5) ²	³	73	8	61	55	56–222	3/4"-10UNC	70	8600322
So-PP-VIP10-3.5 t-1"-8UNC	3.5 (4) ²	³	94	10	81	70	25–74	1"-8UNC	150	8600323
So-PP-VIP13-5 t-1 1/4"-7UNC	5 (6.7) ²	³	108	13	99	85	31–91	1 1/4"-7UNC	225	8600324

¹ So-PP can also be installed with eye hook as So-PP-S or with link as So-PP-B.

² () = Higher WLL with axial load.

³ Weight depends on the design.

Subject to technical changes!

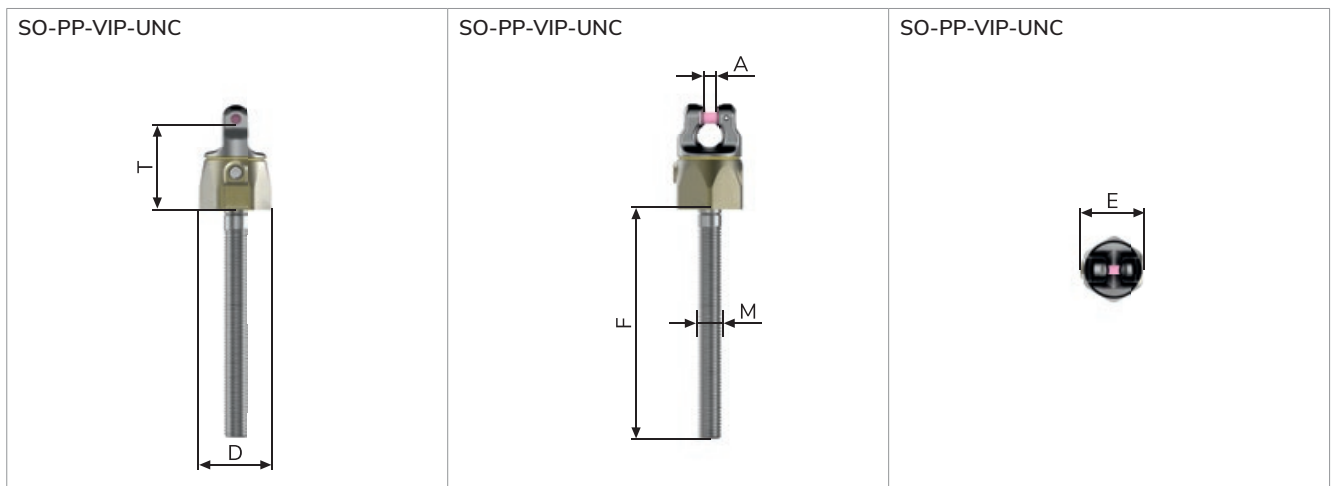







TXP

TXP-Textolution-Point.



PRODUCT FEATURES

- Reliable protection of sensitive load surfaces.
- Unique: safety through guaranteed and tested load-bearing capacity (WLL) for the entire system.
- Avoidance of accidents and damages caused by risky and untested self solutions.
- Weight saving due to textile high-tech component.
- Flexible in use: two lengths and three sizes.

<p>Lengths 0.5 m / 1.0 m.</p> 	<p>Optimal eyelet design – No detrimental deformation of the textile.</p> 	<p>ICE-BOLT¹ combination head bolt.</p> 
<p>Textile sling made of high-tech material.</p> 	<p>Embedded RFID transponder.</p>  <p>RUD RFID CONNECT IT </p>	<p>Ball bearing for safe rotating and turning.</p> 

¹ Deviating grade also possible for special dimensions.

- Captive but interchangeable bolt, sizes M16 / M20 / M24 – also available as UNC, UNF and fine thread.
- ICE-BOLT¹: Maximum strength with particularly high toughness.

TXP

Technical data.

Type	Load capacity WLL [t]	A [mm]	B [mm]	D [mm]	E [mm]	F [mm]	G [mm]	M [mm]	T [mm]	Weight [kg/unit]	Ref.-No.
TXP-1.3tM16 L=0.5 m	1.3	Approx. 35	500	48	41	25	62	M16	560	0.8	7911575
TXP-1.3tM16 L=1.0 m	1.3	Approx. 35	1,000	48	41	25	62	M16	1,060	1.1	7911576
TXP-1.3 t with variable thread	1.3	Approx. 35	500 or 1,000	48	41	16-180	62	M16 Vario ¹	560 or 1,060	2	8600662
						181-225		M16 x 1,5 Vario			
						16-70		5/8"- 11 UNC Vario			
						16-29					
49-180											
TXP-2.0tM20 L=0.5 m	2.0	Approx. 35	500	62	55	34	84	M20	580	1.6	7911569
TXP-2.0tM20 L=1.0 m	2.0	Approx. 35	1,000	62	55	34	84	M20	1,080	1.8	7911570
TXP-2.0 t with variable thread	2.0	Approx. 35	500 or 1,000	62	55	20-223	84	M20 Vario ¹	580 or 1,080	2	8600663
						20-88		M20 x 1,5 Vario			
						22-94		M22 Vario ¹			
						19-29		3/4"- 10 UNC Vario			
						56-222					
						19-66		3/4"- 16 UNF Vario			
TXP-3.0tM24 L=0.5 m	3.0	Approx. 35	500	81	70	36	97	M24	600	2.6	7911556
TXP-3.0tM24 L=1.0 m	3.0	Approx. 35	1,000	81	70	36	97	M24	1,100	2.9	7911557
TXP-3.0 t with variable thread	3.0	Approx. 35	500 or 1,000	81	70	24-257	97	M24 Vario ¹	600 or 1,100	2	8600664
						24-97		M24 x 1,5 Vario			
						24-42		M24 x 2 Vario			
						27-92		M27 Vario ¹			
						25-76		1"- 8 UNC Vario			
						77-246					

¹ With nut and washer possible.

² Weight depending on design.

Subject to technical changes!

DESIGN FACTOR 4:1

Attachment type										
Number of strands	1	1	2	2	2	2	2	3/4	3/4	3/4
Tilt angle α	0-7°	90°	0-7°	90°	0-45°	>45-60°	Asymm.	0-45°	>45-60°	Asymm.
Factor	1	1	2	2	1.4	1	1	2.1	1.5	1
Design factor 4:1 for max. total load weight in tonnes, bolted tight and aligned in direction of tension										
TXP-1.3tM16	1.3	1.3	2.6	2.6	1.82	1.3	1.3	2.73	1.95	1.3
TXP-2.0tM20	2	2	4	4	2.8	2	2	4.25	3	2
TXP-3.0tM24	3	3	6	6	4.25	3	3	6.3	4.5	3

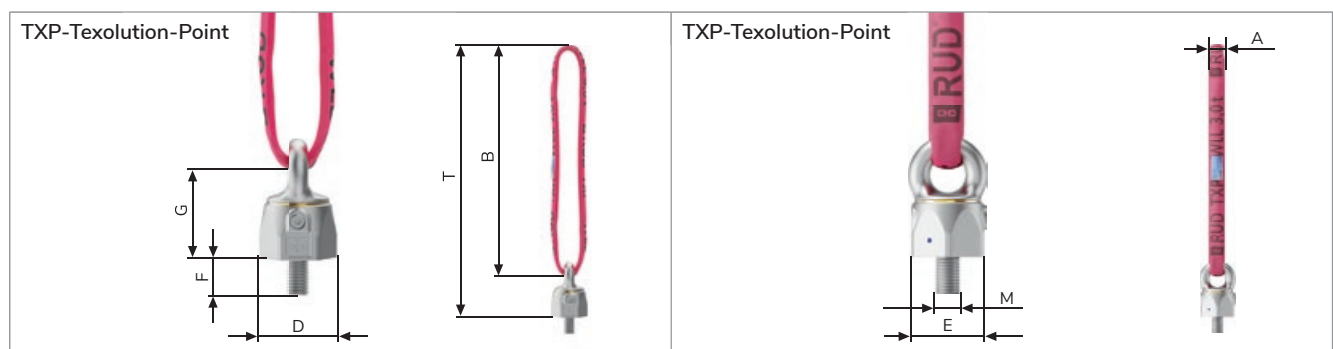

VWBG-V / VWBG

VIP-load ring thread VARIO /
VIP-load ring thread.



VWBG-V

VWBG

PRODUCT FEATURES

- Large WLL range 0.3 t–5 t / 6 t–50 t
- Clear indication of the minimum WLL for all loading directions. Higher WLL by optimised attachment or application.
- Rotatable 90° to the bolt-on direction under rated WLL.
- Variable bolt lengths available for use in threaded and through holes.
- VWBG-V: Non-removable special bolt (do not use unsuitable standard screws).
- VWBG-V: RUD bolts with special corrosion protection Corrud-DT.
- Large clearance between the bolt-on surface and load to prevent damage.

<p>Ball-bearing.</p>	<p>Rotatable through 360°.</p> <p>Extended pivoting area ~230°.</p>	<p>Patented wear marker.</p> <p>Ready to be discarded.</p> <p>New.</p>
<p>WLL X</p>	<p>WLL Y</p>	<p>WLL Z</p>



✓ VWBG-V: Tested and certified by DGUV.
 Test criteria: GS-HM-36:2021-09
 Certificate no.: HM 220055
 VWBG corresponds with the test criteria:
 GS-OA-15-04

- 360° rotatable, 230° pivotable.
- Ball bearing for shock-free and less friction when rotating and turning.
- Optical markings to determine the load angle and wear occurrence.

VWBG-V / VWBG

Metric thread.

VWBG-V LOAD RING – METRIC.

Type	WLL-X [t]	WLL-Y [t]	WLL-Z [t]	Weight (kg/unit)	T [mm]	A [mm]	B [mm]	C [mm]	D [mm]	E [mm]	F [mm]	G [mm]	M	Tightening torque [Nm]	Ref. No.
VWBG-V 0.3-M8	0.3	0.4	0.6	0.18	76	8	31	29	30	27	13	36	M8	10	7103720
VWBG-V 0.45-M10	0.45	0.6	0.9	0.29	78	8	31	29	33.5	30	17	38	M10	10	7103715
VWBG-V 0.6-M12	0.6	0.75	1.2	0.41	107	10	49	35	42	36	21	47	M12	10	7100180
VWBG-V 1-M14 (F = 21)	1	1.25	2	0.63	114	13	46	38	48	41	21	56	M14	25	7910221
VWBG-V 1.3-M16	1.3	1.5	2.6	0.59	114	13	46	38	48	41	25	56	M16	30	7100430
VWBG-V 1.8-M18 (F = 27)	1.8	2	3.6	1.18	137	13	54	35	62	55	27	67	M18	50	8600338
VWBG-V 2-M20	2	2.5	4	1.42	137	13	54	35	62	55	33	67	M20	70	7100800
VWBG-V 2-M22 (F = 33)	2	2.5	4	1.45	137	13	54	35	62	55	33	67	M22	120	8600334
VWBG-V 3.5-M24	3.5	4	7	2.63	173	18	66	40	81	70	40	88	M24	150	7100640
VWBG-V 3.5-M27 (F = 41)	3.5	4	7	2.65	173	18	66	40	81	70	41	88	M27	200	8600335
VWBG-V 5-M30	5	6	10	5.09	221	22	90	50	99	85	50	106	M30	225	7100650

Subject to technical changes!

VWBG LOAD RING – METRIC.

Type	WLL-X [t]	WLL-Y [t]	WLL-Z [t]	Weight (kg/unit)	T [mm]	A [mm]	B [mm]	C [mm]	D [mm]	E [mm]	F [mm]	G [mm]	M	Tightening torque [Nm]	Ref. No.
VWBG 6(7.5) t-M33 (F = 50)	6	7.5	15	4.7	208	22	86	50	90	80	50	94	M33	350	8600150
VWBG 8(10) t-M36	8	10	15	4.7	208	22	86	50	90	80	54	94	M36	410	7999059
VWBG 12(13) t-M42	12	13	17	6.1	234	26	111	65	98	85	63	95	M42	550	7999044
VWBG 12(15) t-M45	12	15	18	6.2	234	26	111	65	98	85	67	95	M45	550	7900455
VWBG 13(16) t-M48	13	16	18	6.8	234	26	111	65	98	85	68	95	M48	550	7999045
VWBG 14(20) t-M52	14	20	25	10.6	271	32	119	70	120	95	78	120	M52	750	7910181
VWBG 16(22) t-M56	16	22	28	10.7	271	32	119	70	120	95	84	120	M56	800	7999004
VWBG 16(22) t-M60 (F = 90)	16	22	28	11.4	271	32	119	70	120	95	90	120	M60	800	8600454
VWBG 16(25) t-M64	16	25	28	11.4	271	32	119	70	120	95	94	120	M64	800	7999043
VWBG 31.5(40) t-M72	31.5	40	50	30	338	46	130	90	170	145	108	159	M72	1.200	7900097
VWBG 35(48) t-M80	35	48	50	31	338	46	130	90	170	145	120	159	M80	1.500	7900100
VWBG 40(50) t-M90	40	50	50	35	378	46	168	110	170	145	135	159	M90	2.000	7903408
VWBG 40(50) t-M100 (F = 150)	40	50	50	37	378	46	168	110	170	145	150	159	M100	2.000	8600458

Subject to technical changes!

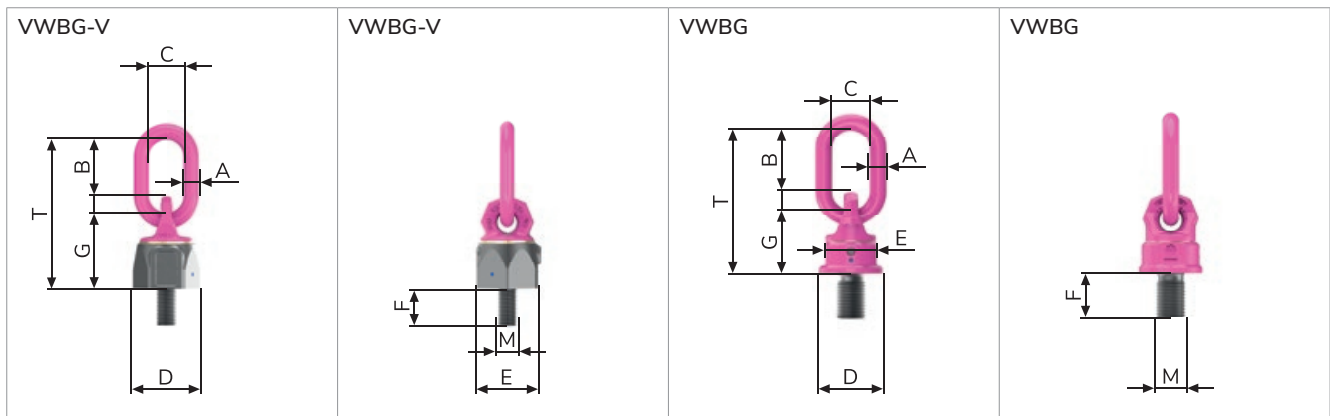

VWBG-V / VWBG

Metric thread in variable length.

VWBG-V LOAD RING – METRIC IN VARIABLE LENGTH.

Type	WLL-X [t]	WLL-Y [t]	WLL-Z [t]	Weight (kg/unit)	T [mm]	A [mm]	B [mm]	C [mm]	D [mm]	E [mm]	F vario [mm]	G [mm]	M	Tightening torque [Nm]	Ref. No.
VWBG-V 0.3-M8	0.3	0.4	0.6	¹	76	8	31	29	30	27	8-102	36	M8	10	8600330
VWBG-V 0.45-M10	0.45	0.6	0.9	¹	78	8	31	29	33.5	30	10-122	38	M10	10	8600331
VWBG-V 0.6-M12	0.6	0.75	1.2	¹	107	10	49	35	42	36	12-140	47	M12	10	8600332
VWBG-V 1-M14	1	1.25	2	¹	114	13	46	38	48	41	14-160	56	M14	25	8600337
VWBG-V 1.3-M16	1.3	1.5	2.6	¹	114	13	46	38	48	41	16-225	56	M16	30	8600333
VWBG-V 1.8-M18	1.8	2	3.6	¹	137	13	54	35	62	55	18-83	67	M18	50	8600338
VWBG-V 2-M20	2	2.5	4	¹	137	13	54	35	62	55	20-223	67	M20	70	8600334
VWBG-V 2-M22	2	2.5	4	¹	137	13	54	35	62	55	22-94	67	M22	120	8600334
VWBG-V 3.5-M24	3.5	4	7	¹	173	18	66	40	81	70	24-257	88	M24	150	8600335
VWBG-V 3.5-M27	3.5	4	7	¹	173	18	66	40	81	70	27-92	88	M27	200	8600335
VWBG-V 5-M30	5	6	10	¹	221	22	90	50	99	85	30-330	106	M30	225	8600336

¹ Weight depends on the design.

Subject to technical changes!

VWBG LOAD RING – METRIC IN VARIABLE LENGTH.

Type	WLL-X [t]	WLL-Y [t]	WLL-Z [t]	Weight (kg/unit)	T [mm]	A [mm]	B [mm]	C [mm]	D [mm]	E [mm]	F vario [mm]	G [mm]	M	Tightening torque [Nm]	Ref. No.
VWBG 6(7.5) t	6	7.5	15	¹	208	22	86	50	90	80	33-300	94	M33	350	8600150
VWBG 8(10) t	8	10	15	¹	208	22	86	50	90	80	36-300	94	M36-M39	410	8600451
VWBG 12(13) t	12	13	17	¹	234	26	111	65	98	85	42-300	95	M42-M45	550	8600452
VWBG 13(16) t	13	16	18	¹	234	26	111	65	98	85	48-300	95	M48-M52	550	8600453
VWBG 14(20) t	14	20	25	¹	271	32	119	70	120	95	52-300	120	M52	750	8600158
VWBG 16(22) t	16	22	28	¹	271	32	119	70	120	95	56-300	120	M56-M60	800	8600454
VWBG 16(25) t	16	25	28	¹	271	32	119	70	120	95	64-300	120	M64-M76	800	8600455
VWBG 31.5(40) t	31.5	40	50	¹	338	46	130	90	170	145	72-300	159	M72-M76	1.200	8600456
VWBG 35(48) t	35	48	50	¹	338	46	130	90	170	145	80-300	159	M80-M85	1.500	8600457
VWBG 40(50) t	40	50	50	¹	378	46	168	110	170	145	90-300	159	M90-M150	2.000	8600458

¹ Weight depends on the design.

Subject to technical changes!

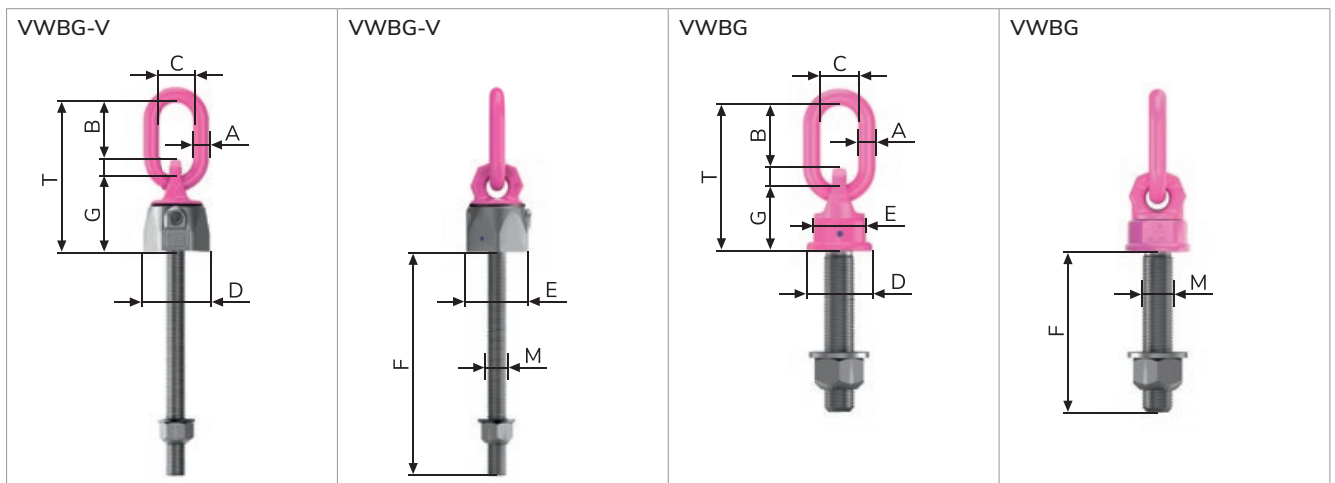

VWBG-V / VWBG

Metric fine thread in variable length.

VWBG-V LOAD RING – METRIC FINE THREAD IN VARIABLE LENGTH.

Type	WLL-X [t]	WLL-Y [t]	WLL-Z [t]	Weight (kg/unit)	T [mm]	A [mm]	B [mm]	C [mm]	D [mm]	E [mm]	F vario [mm]	G [mm]	M	Tightening torque [Nm]	Ref. No.
VWBG-V 0.6-M12 × 1.5	0.6	0.75	1.2	¹	107	10	49	35	42	36	12–55	47	M12 × 1.5	10	8600332
VWBG-V 1-M14 × 1.5	1	1.25	2	¹	114	13	46	38	48	41	14–65	56	M14 × 1.5	25	8600337
VWBG-V 1.3-M16 × 1.5	1.3	1.5	2.6	¹	114	13	46	38	48	41	16–70	56	M16 × 1.5	30	8600333
VWBG-V 1.8-M18 × 1.5	1.8	2	3.6	¹	137	13	54	35	62	55	18–83	67	M18 × 1.5	50	8600338
VWBG-V 2-M20 × 1.5	2	2.5	4	¹	137	13	54	35	62	55	20–88	67	M20 × 1.5	70	8600334
VWBG-V 3.5-M24 × 1.5	3.5	4	7	¹	173	18	66	40	81	70	24–97	88	M24 × 1.5	150	8600335
VWBG-V 3.5-M24 × 2	3.5	4	7	¹	173	18	66	40	81	70	24–42	88	M24 × 2	150	8600335
VWBG-V 5-M30 × 2	5	6	10	¹	221	22	90	50	99	85	30–125	106	M30 × 2	225	8600336

¹ Weight depends on the design.

Subject to technical changes!

VWBG LOAD RING – METRIC FINE THREAD IN VARIABLE LENGTH.

Type	WLL-X [t]	WLL-Y [t]	WLL-Z [t]	Weight (kg/unit)	T [mm]	A [mm]	B [mm]	C [mm]	D [mm]	E [mm]	F vario [mm]	G [mm]	M	Tightening torque [Nm]	Ref. No.
VWBG 6(7.5) t-M33 × 2	6	7.5	15	¹	208	22	86	50	90	80	33–300	94	M33 × 2	350	8600150
VWBG 8(10) t-M36 × 3	8	10	15	¹	208	22	86	50	90	80	36–300	94	M36 × 3	410	8600451
VWBG 12(13) t-M42 × 3	12	13	17	¹	234	26	111	65	98	85	42–300	95	M42 × 3	550	8600452
VWBG 13(16) t-M48 × 3	13	16	18	¹	234	26	111	65	98	85	48–300	95	M48 × 3	550	8600453
VWBG 16(22) t-M56 × 4	16	22	28	¹	271	32	119	70	120	95	56–300	120	M56 × 4	800	8600454
VWBG 16(25) t-M64 × 4	16	25	28	¹	271	32	119	70	120	95	64–300	120	M64 × 4	800	8600455
VWBG 31.5(40) t-M72 × 4	31.5	40	50	¹	338	46	130	90	170	145	72–300	159	M72 × 4	1.200	8600456
VWBG 35(48) t-M80 × 4	35	48	50	¹	338	46	130	90	170	145	80–300	159	M80 × 4	1.500	8600457
VWBG 40(50) t-M90 × 4	40	50	50	¹	378	46	168	110	170	145	90–300	159	M90 × 4	2.000	8600458

¹ Weight depends on the design.

Subject to technical changes!

VWBG: further fine thread designs on request.

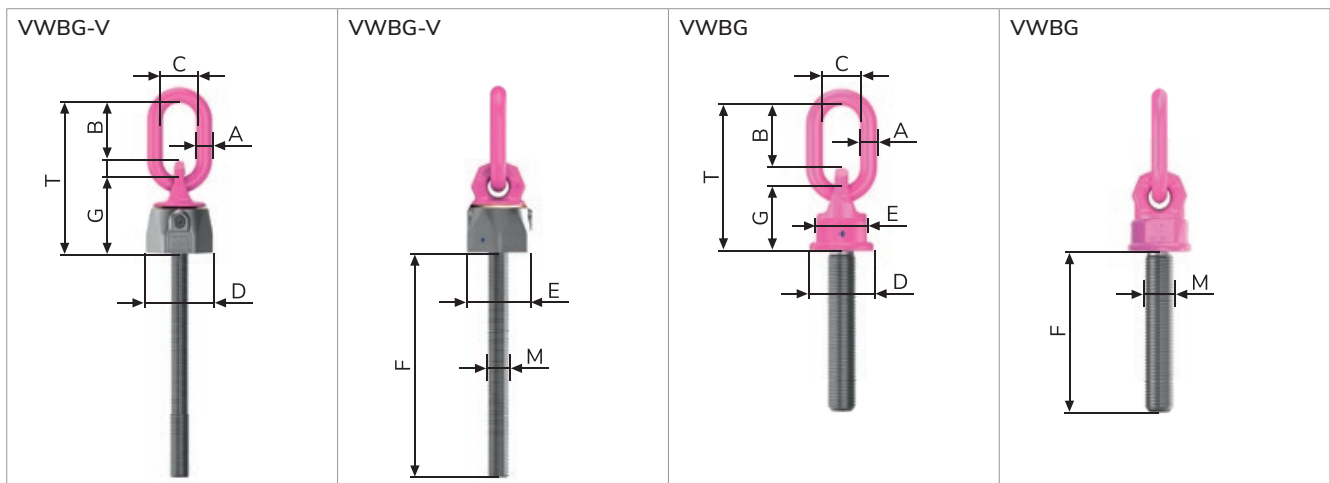

VWBG-V

UNC inch thread.

VWBG-V LOAD RING – UNC INCH THREAD.

Type	WLL-X [t]	WLL-Y [t]	WLL-Z [t]	Weight (kg/unit)	T [mm]	A [mm]	B [mm]	C [mm]	D [mm]	E [mm]	F [mm]	G [mm]	M	Tightening torque [Nm]	Ref. No.
VWBG-V 0.3-5/16"-18UNC	0.3	0.4	0.6	0.18	76	8	31	29	30	27	13	36	5/16"-18UNC	10	7991090
VWBG-V 0.45-3/8"-16UNC	0.45	0.6	0.9	0.29	78	8	31	29	33.5	30	17	38	3/8"-16UNC	10	7991091
VWBG-V 0.6-1/2"-13UNC	0.6	0.75	1.2	0.41	107	10	49	35	42	36	21	47	1/2"-13UNC	10	7991092
VWBG-V 1.3-5/8"-11UNC	1.3	1.5	2.6	0.52	114	13	46	38	48	41	29	56	5/8"-11UNC	30	7991093
VWBG-V 2-3/4"-10UNC	2	2.5	4	1.42	137	13	54	35	62	55	28	67	3/4"-10UNC	70	7991094
VWBG-V 3.5-1"-8UNC	3.5	4	7	2.63	173	18	66	40	81	70	38	88	1"-8UNC	150	7991095
VWBG-V 5-1 1/4"-7UNC	5	6	10	5.09	221	22	90	50	99	85	47	106	1 1/4"-7UNC	225	7991096

Subject to technical changes!

VWBG-V LOAD RING – UNC INCH THREAD IN VARIABLE LENGTH.

Type	WLL-X [t]	WLL-Y [t]	WLL-Z [t]	Weight (kg/unit)	T [mm]	A [mm]	B [mm]	C [mm]	D [mm]	E [mm]	F vario [mm]	G [mm]	M	Tightening torque [Nm]	Ref. No.
VWBG-V 0.45-3/8"-16UNC	0.45	0.6	0.9	¹	78	8	31	29	33.5	30	31-124	38	3/8"-16UNC	10	8600331
VWBG-V 0.6-1/2"-13UNC	0.6	0.75	1.2	¹	107	10	49	35	42	36	40-149	47	1/2"-13UNC	10	8600332
VWBG-V 1.3-5/8"-11UNC	1.3	1.5	2.6	¹	114	13	46	38	48	41	49-180	56	5/8"-11UNC	30	8600333
VWBG-V 2-3/4"-10UNC	2	2.5	4	¹	137	13	54	35	62	55	56-222	67	3/4"-10UNC	70	8600334
VWBG-V 3.5-1"-8UNC	3.5	4	7	¹	173	18	66	40	81	70	64-246	88	1"-8UNC	150	8600335
VWBG-V 5-1 1/4"-7UNC	5	6	10	¹	221	22	90	50	99	85	77-331	106	1 1/4"-7UNC	225	8600336

¹ Weight depends on the design.

Subject to technical changes!

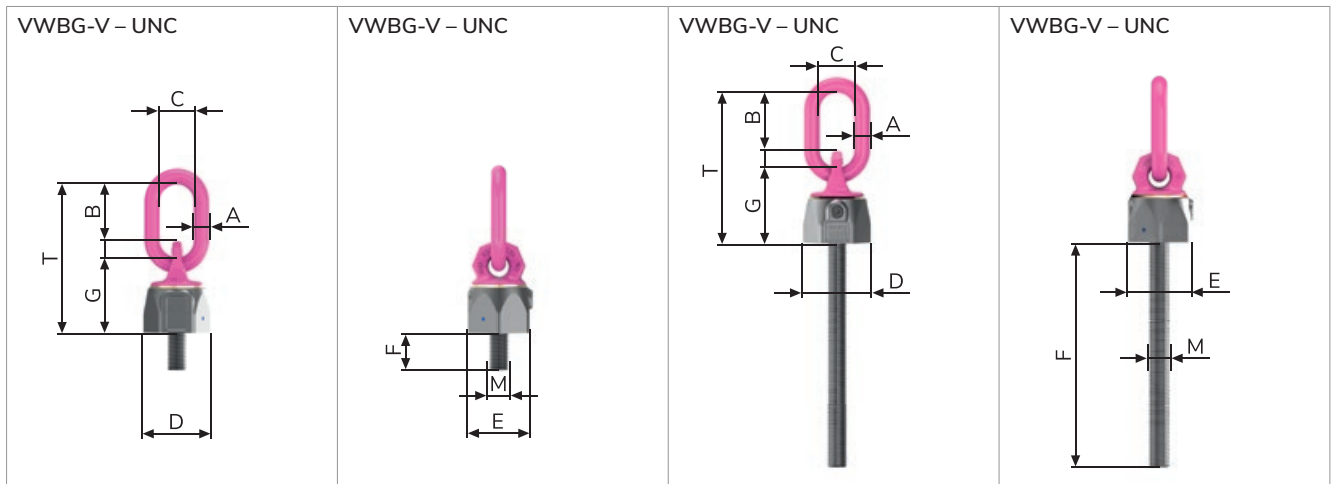

VWBG

UNC inch thread / BSW-Whitworth inch thread.

VWBG LOAD RING – UNC INCH THREAD IN VARIABLE LENGTH.

Type	WLL-X [t]	WLL-Y [t]	WLL-Z [t]	T [mm]	A [mm]	B [mm]	C [mm]	D [mm]	E [mm]	F vario [mm]	G [mm]	M	Tightening torque [Nm]	Ref. No.
VWBG 8(10) t – 1 1/2"-6UNC (F = 57)	8	10	15	208	22	86	50	90	80	36-300	94	1 1/2"-6UNC	410	8600451
VWBG 12(13) t – 1 3/4"-5UNC (F = 66)	12	13	17	234	26	111	65	98	85	42-300	95	1 3/4"-5UNC	550	8600452
VWBG 13(16) t – 2"-4.5UNC (F = 76)	13	16	18	234	26	111	65	98	85	48-300	95	2"-4.5UNC	550	8600453
VWBG 16(22) t – 2 1/4"-4.5UNC (F = 85)	16	22	28	271	32	119	70	120	95	56-300	120	2 1/4"-4.5UNC	800	8600454
VWBG 16(22) t – 2 1/2"-4UNC (F = 95)	16	22	28	271	32	119	70	120	95	56-300	120	2 1/2"-4UNC	800	8600454
VWBG 16(25) t – 2 3/4"-4UNC (F = 104)	16	25	28	271	32	119	70	120	95	64-300	120	2 3/4"-4UNC	800	8600455
VWBG 31.5(40) t – 3"-4UNC (F = 114)	31.5	40	50	338	46	130	90	170	145	72-300	159	3"-4UNC	1.200	8600456
VWBG 35(48) t – 3 1/2"-4UNC (F = 133)	35	48	50	338	46	130	90	170	145	80-300	159	3 1/2"-4UNC	1.500	8600457
VWBG 40(50) t – 4"-4UNC (F = 150)	40	50	50	378	46	168	110	170	145	90-300	159	4"-4UNC	2.000	8600458
VWBG 40(50) t – 4 1/2"-4UNC (F = 170)	40	50	50	378	46	168	110	170	145	90-300	159	4 1/2"-4UNC	2.000	8600458
VWBG 40(50) t – 5"-4UNC (F = 190)	40	50	50	378	46	168	110	170	145	90-300	159	5"-4UNC	2.000	8600458

Weight depends on the design.

Subject to technical changes!

VWBG LOAD RING – BSW-WHITWORTH INCH THREAD IN VARIABLE LENGTH.

Type	WLL-X [t]	WLL-Y [t]	WLL-Z [t]	T [mm]	A [mm]	B [mm]	C [mm]	D [mm]	E [mm]	F vario [mm]	G [mm]	M	Tightening torque [Nm]	Ref. No.
VWBG 8(10) t – 1 1/2"-BSW (F = 57)	8	10	15	208	22	86	50	90	80	36-300	94	1 1/2"-BSW	410	8600451
VWBG 12(13) t – 1 3/4"-BSW (F = 66)	12	13	17	234	26	111	65	98	85	42-300	95	1 3/4"-BSW	550	8600452
VWBG 13(16) t – 2"-BSW (F = 76)	13	16	18	234	26	111	65	98	85	48-300	95	2"-BSW	550	8600453
VWBG 16(22) t – 2 1/4"-BSW (F = 85)	16	22	28	271	32	119	70	120	95	56-300	120	2 1/4"-BSW	800	8600454
VWBG 16(22) t – 2 1/2"-BSW (F = 95)	16	22	28	271	32	119	70	120	95	56-300	120	2 1/2"-BSW	800	8600454
VWBG 16(25) t – 2 3/4"-BSW (F = 104)	16	25	28	271	32	119	70	120	95	64-300	120	2 3/4"-BSW	800	8600455
VWBG 31.5(40) t – 3"-BSW (F = 114)	31.5	40	50	338	46	130	90	170	145	72-300	159	3"-BSW	1.200	8600456
VWBG 35(48) t – 3 1/2"-BSW (F = 133)	35	48	50	338	46	130	90	170	145	80-300	159	3 1/2"-BSW	1.500	8600457
VWBG 40(50) t – 4"-BSW (F = 150)	40	50	50	378	46	168	110	170	145	90-300	159	4"-BSW	2.000	8600458
VWBG 40(50) t – 4 1/2"-BSW (F = 170)	40	50	50	378	46	168	110	170	145	90-300	159	4 1/2"-BSW	2.000	8600458
VWBG 40(50) t – 5"-BSW (F = 190)	40	50	50	378	46	168	110	170	145	90-300	159	5"-BSW	2.000	8600458

Weight depends on the design.

Subject to technical changes!

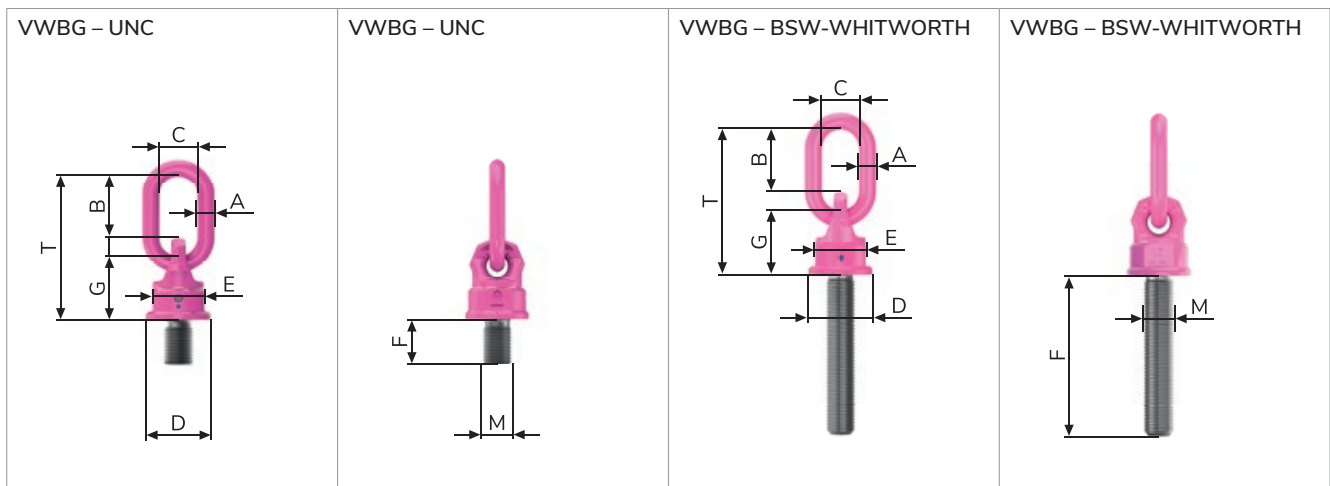

WBPG

Boltable plate hoist ring.



RUD RFID
CONNECT IT



PRODUCT FEATURES

- Large WLL range 85 t–250 t.
- Suspension ring, resp. shackle pivots 180°.
- Lifting point swivels 360°.
- Removable suspension ring in shape of a shackle for attaching in conventional lifting means.
- Original RUD bolt with special corrosion protection Corrud-DT for 85 t–250 t.
- Installation possible with clevis, ring and allen key.
- Also available with sling shackle as suspension ring (WBPG-SL).

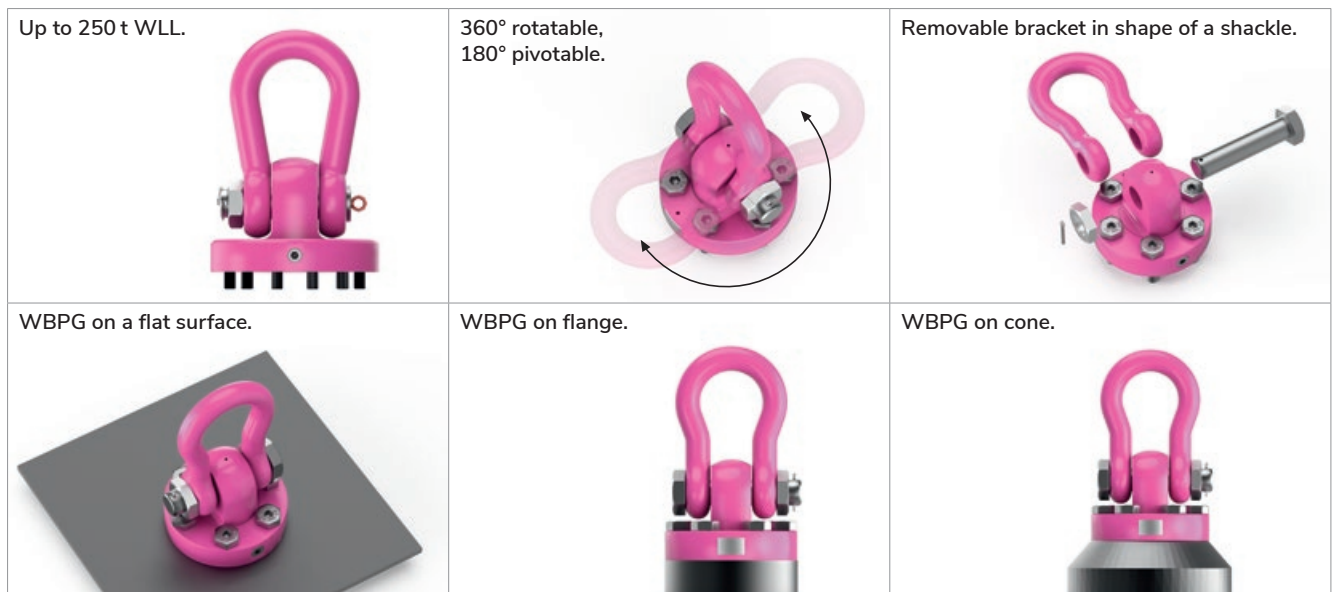

- Heavy-duty design.
- WLL up to 250 t.
- Rotatable through 360°.

WBPG

Metric thread.

WBPG – METRIC THREAD.

Type	WLL [t]	Weight (kg/unit)	T [mm]	A [mm]	B [mm]	D [mm]	E [mm]	F [mm]	G [mm]	H [mm]	I [mm]	K [mm]	M	N [mm]	Tightening torque [Nm]	Ref. No.
WBPG 85 t/400 mm 6 × M48	85	170	577	400	75	190	89	304	273	310	73	71	6 × M48	83	6.000	7993712
WBPG 100 t/400 mm 6 × M48	100	198	577	400	83	190	89	304	273	310	73	71	6 × M48	83	6.000	7993245
WBPG 120 t/570 mm 6 × M48	120	360	651	571	95	238	110	344	307	445	77	75	6 × M48	95	6.000	7900917
WBPG 200 t/650 mm 10 × M48	200	671	880	650	120	290	100	460	426	500	73	71	10 × M48	130	6.000	7900383
WBPG 250 t/730 mm 12 × M48	250	992	920	730	130	305	138	496	424	580	74	72	12 × M48	140	6.000	7905690
WBPG-SL 250 t/730 mm 12 × M48	250	844	844	730	126	300	138	452	380	580	74	72	12 × M48	120	6.000	7909644

Subject to technical changes!

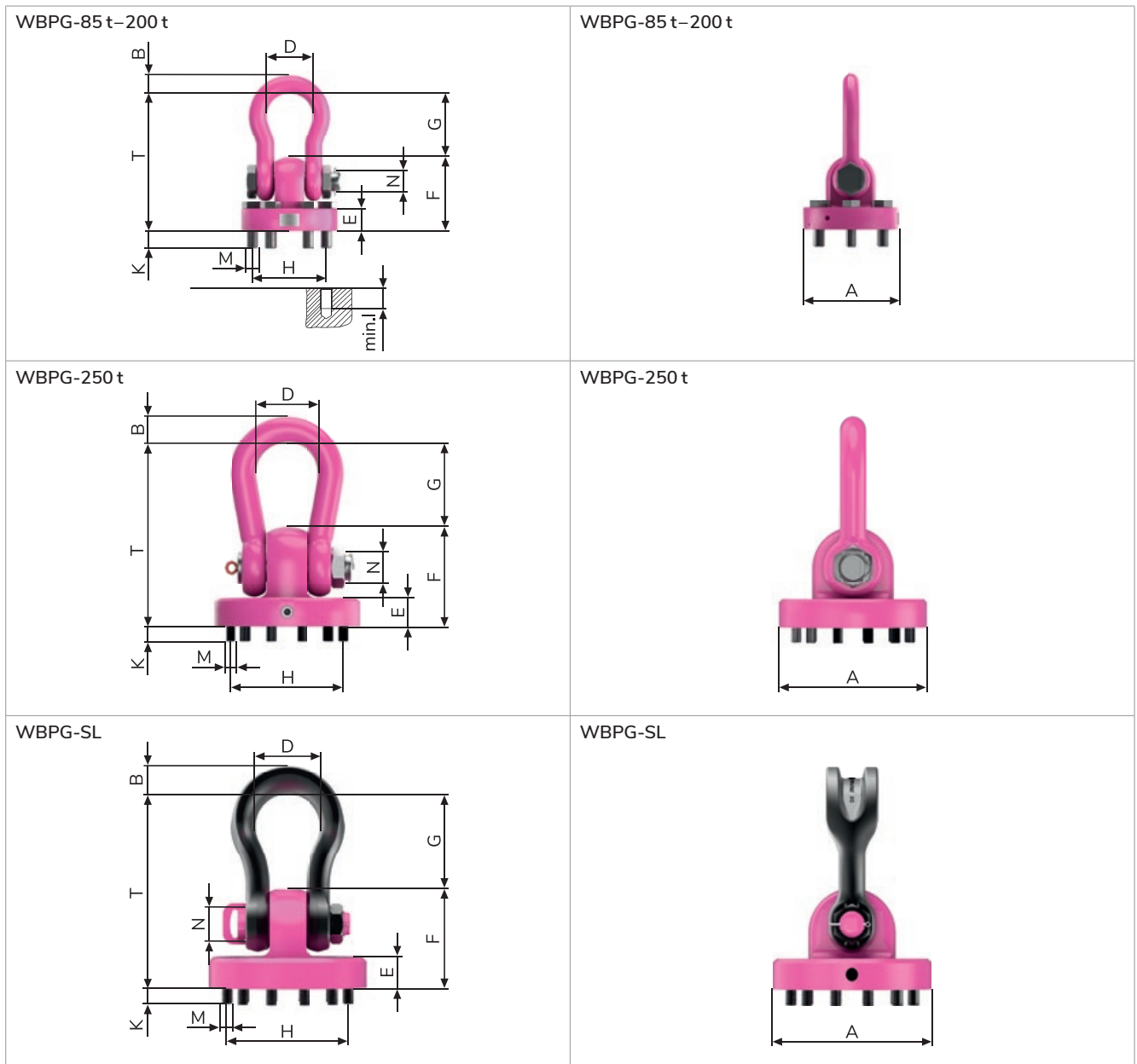

VRS-STARPOINT

VARIO-Ring bolt.

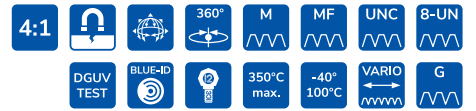

VRS-F (with wrench)

VRS (without wrench)

PRODUCT FEATURES

- Large WLL range 0.1 t–20 t.
- Non-detachable ICE-Bolt made of patent steel (M6–M24), thus reducing the risk of using unsuitable standard bolts. Special bolt for safe deep temperature usage with higher toughness and thus higher bending strength as well as less wear.
- The WLL information corresponds with the min. WLL (worst case scenario) in all loading directions. Higher WLL by optimised attachment or application.
- Variable bolt lengths available for use in threaded and through holes.
- Comprehensive range of threads.

<p>RUD ICE-Bolt. Up to M24.</p>	<p>Rotatable through 360°.</p> <p>Simple adjustment in load direction.</p>	<p>Variable bolt length.</p>
<p>WLL Y</p>	<p>WLL Z</p>	<p>Star profile key –</p> <p>metric UNC inch thread</p>



✓ Tested and certified by DGVU.
 Test criteria: GS-OA-15-04: 2015-12
 Certificate no.: OA 1951039

- Rotatable through 360°.
- Much higher WLL than eye bolts in accordance with DIN 580.
- Star profile key for simple installation and removal.

VRS-F / VRS

Metric thread with and without key.

VRS-F / VRS STARPOINT – METRIC WITH (VRS-) AND WITHOUT KEY.

Type	WLL [t]	Weight VRS-F (kg/unit)	Weight VRS (kg/unit)	T [mm]	B [mm]	C [mm]	D [mm]	E [mm]	G [mm]	I [mm]	K [mm]	L [mm]	M	N [mm]	Tightening torque [Nm]	Ref. No. VRS-F	Ref. No. VRS
VRS-F-M6 / VRS-M6	0.1	0.07	0.07	28	9	7	20	23	28	13	37	9	M6	6	5	7900906	7900909
VRS-F-M8 / VRS-M8	0.3	0.12	0.1	35	11	9	25	25	30	16.3	47	12	M8	6	10	8500911	7100554
VRS-F-M10 / VRS-M10	0.4	0.12	0.1	35	11	9	25	25	30	16.3	47	15	M10	6	10	7104029	7100555
VRS-F-M12 / VRS-M12	0.75	0.19	0.19	42	13	10	30	30	34	19.8	56	18	M12	8	25	7101313	7100556
VRS-F-M14 / VRS-M14	0.75	0.22	0.2	42	13	10	30	30	34	19.8	56	18	M14	8	30	7999330	7100557
VRS-F-M16 / VRS-M16	1.5	0.36	0.33	49	15	13	35	36	40	23.5	65	24	M16	10	60	7101314	7100558
VRS-F-M18 / VRS-M18	1.5	0.37	0.33	49	15	13	35	36	40	23.5	65	24	M18	10	60	7903387	7992219
VRS-F-M20 / VRS-M20	2.3	0.6	0.54	58	17	16	40	41	50	29.3	76	30	M20	12	115	7101315	7100559
VRS-F-M22 / VRS-M22	2.3	0.62	0.56	58	17	16	40	41	50	29.3	76	30	M22	12	125	7992197	7904625
VRS-F-M24 / VRS-M24	3.2	1.06	0.97	70	20	19	49	51	60	35	92	36	M24	14	190	7101316	7100560
VRS-M24-SL2M	3.2	-	1	70	20	19	49	51	60	35	92	48	M24	14	190	-	7990615
VRS-F-M27 / VRS-M27	3.2	1.08	1	70	20	19	49	51	60	35	92	36	M27	14	250	7994138	7904626
VRS-F-M30 / VRS-M30	4.5	2.08	1.92	87	26	24	60	66	75	44	114	45	M30	17	330	7101317	7100561
VRS-F-M33 / VRS-M33	4.5	2.13	1.97	87	26	24	60	66	75	44	114	45	M33	17	350	7993439	7904627
VRS-F-M36 / VRS-M36	7	3.5	3.3	104	32	29	73	76	98	53	135	54	M36	22	590	7984201	7984198
VRS-F-M36-SL2M	7	-	3.3	104	32	29	73	76	98	53	135	72	M36	22	590	-	7991247
VRS-F-M42 / VRS-M42	9	5.4	5	122	36	34	85	86	109	62	157	63	M42	24	925	7984202	7984199
VRS-F-M48 / VRS-M48	12	8.1	7.6	138	42	38	96	101	128	70	179	72	M48	27	1.400	7984203	7984200
VRS-F-M56 / VRS-M56"	16	13	11.9	161	50	44	110	112	145	82	209	84	M56	32	1.400	7910836	7907508
VRS-F-M64 / VRS-M64"	20	17.8	16.2	176	55	48	120	122	157	90	228	96	M64	36	1.400	7910837	7907509

Subject to technical changes!

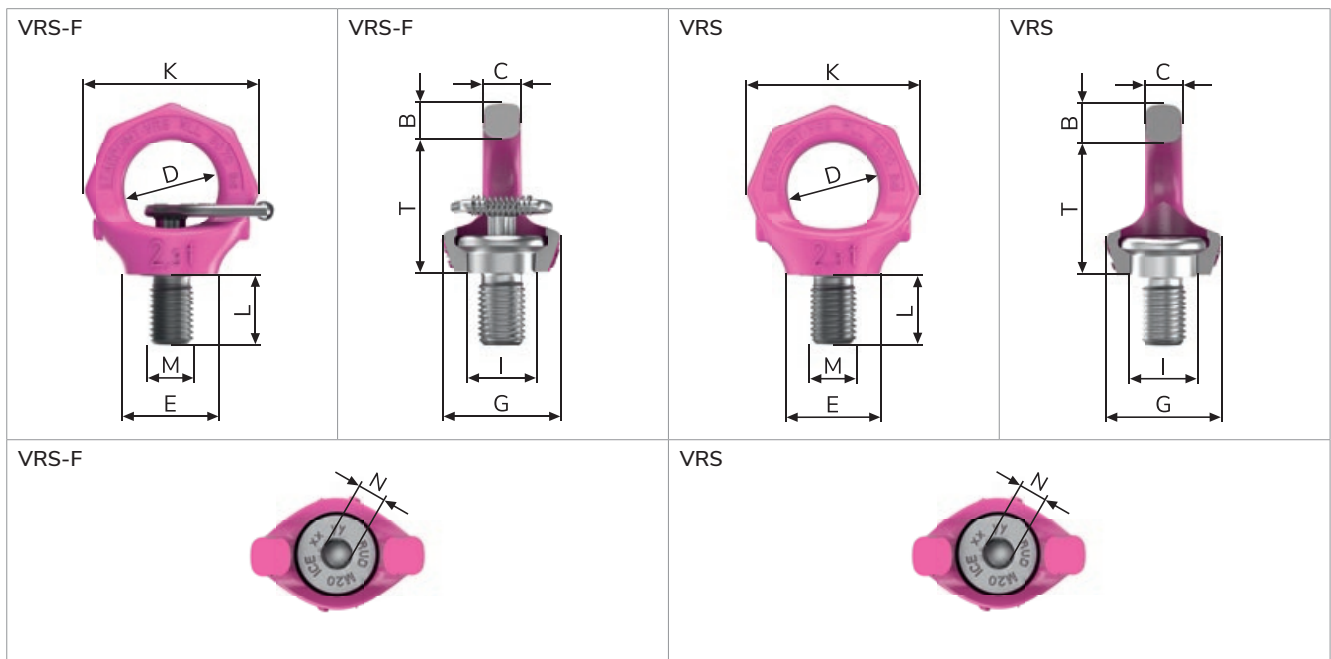

VRS-F / VRS-G

Metric fine thread / metric with variable length / pipe thread.

VRS-F STARPOINT – METRIC FINE THREAD.

Type	WLL [t]	Weight (kg/unit)	T [mm]	B [mm]	C [mm]	D [mm]	E [mm]	G [mm]	I [mm]	K [mm]	L [mm]	M	N [mm]	Tightening torque [Nm]	Ref. No. VRS-F
VRS-F-M8 x 1	0.3	0.12	35	11	9	25	25	30	16.3	47	12	M8 x 1	6	10	7904332
VRS-F-M12 x 1.5	0.75	0.21	42	13	10	30	30	34	19.8	56	18	M12 x 1.5	8	25	7992929
VRS-F-M16 x 1.5	1.5	0.36	49	15	13	35	36	40	23.5	65	24	M16 x 1.5	10	60	7902676
VRS-F-M20 x 2	2.3	0.6	58	17	16	40	41	50	29.3	76	30	M20 x 2	12	115	7992634
VRS-F-M24 x 2	3.2	1.06	70	20	19	49	51	60	35	92	36	M24 x 2	14	190	7992566
VRS-F-M30 x 2	4.5	2.08	87	26	24	60	66	75	44	114	45	M30 x 2	17	330	7991856
VRS-M36 x 3	7	3.3	104	32	29	73	76	98	53	135	54	M36 x 3	22	590	7992728

Subject to technical changes!

VRS-F STARPOINT – METRIC WITH VARIABLE LENGTH.

Type	WLL [t]	Weight (kg/unit)	T [mm]	B [mm]	C [mm]	D [mm]	E [mm]	G [mm]	I [mm]	K [mm]	L vario [mm]	M	N [mm]	Tightening torque [Nm]	Ref. No. VRS-F
VRS-F-M10	0.4	¹	35	11	9	25	25	30	16.3	47	16-70	M10	6	10	8600270
VRS-F-M12	0.75	¹	42	13	10	30	30	34	19.8	56	19-150	M12	8	25	8600271
VRS-F-M16	1.5	¹	49	15	13	35	36	40	23.5	65	25-120	M16	10	60	8600272
VRS-F-M20	2.3	¹	58	17	16	40	41	50	29.3	76	31-160	M20	12	115	8600273
VRS-F-M24	3.2	¹	70	20	19	49	51	60	35	92	37-140	M24	14	190	8600274
VRS-F-M30	4.5	¹	87	26	24	60	66	75	44	114	46-190	M30	17	330	8600275

¹ Weight depends on the design.

Subject to technical changes!

VRS-G STARPOINT – PIPE THREAD ISO 228-1.

Type	WLL [t]	Weight (kg/unit)	T [mm]	B [mm]	C [mm]	D [mm]	E [mm]	G [mm]	I [mm]	K [mm]	L [mm]	M	N [mm]	Tightening torque [Nm]	Ref. No. VRS-G
VRS-G 1/4" ²	0.75	0.2	42	13	10	30	30	-	19.8	56	18	G 1/4"	8	25	7999269
VRS-G 1/2"	0.75	0.3	52	13	10	30	35	30	-	56	20	G 1/2"	8	25	7998682
VRS-G 3/4"	1.5	0.53	61	15	13	35	42	36	-	65	23	G 3/4"	10	60	7998880
VRS-G 1"	1.5	0.6	61	15	13	35	47	41	-	65	32	G 1"	10	60	7999163
VRS-G 1 1/4"	1.5	1	64	15	13	35	58	50	-	65	40	G 1 1/4"	10	60	7903732
VRS-G 2"	1.5	1.5	64	15	13	35	81	70	-	65	45	G 2"	10	100	7999164
VRS-G 2"	2.3	1.9	73	17	16	40	81	70	-	76	45	G 2"	12	115	7900433

² Identical to VRS metric.

Subject to technical changes!

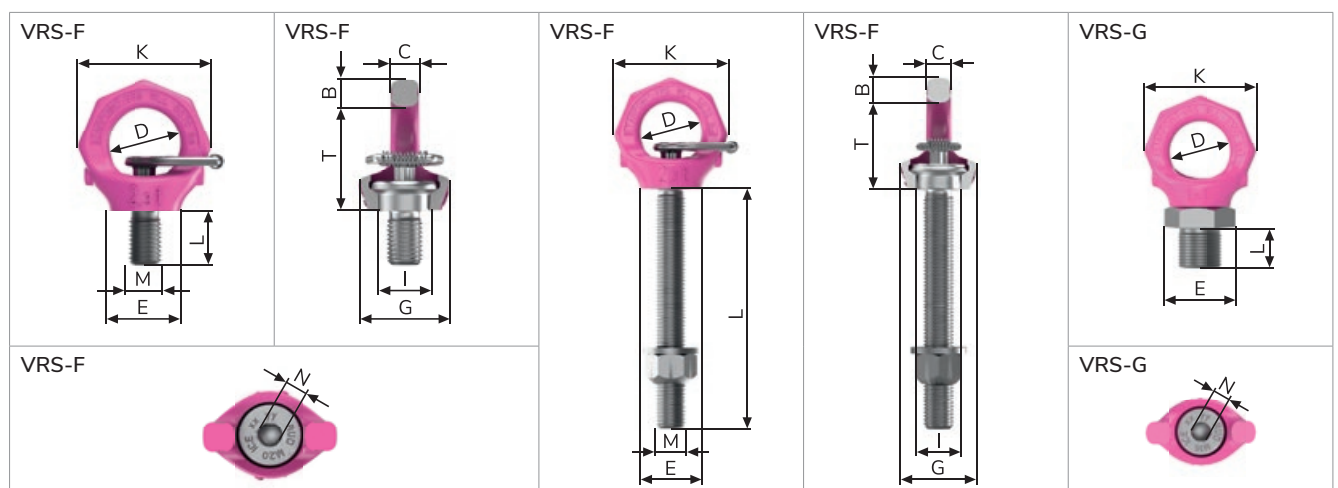

VRS-F / VRS

UNC inch thread with and without key.

VRS-F / VRS STARPOINT – UNC INCH THREAD WITH (VRS-F) AND WITHOUT (VRS) KEY.

Type	WLL [t]	Weight VRS-F (kg/unit)	Weight VRS (kg/unit)	T [mm]	B [mm]	C [mm]	D [mm]	E [mm]	G [mm]	I [mm]	K [mm]	L [mm]	M	N [mm]	Tightening torque [Nm]	Ref. No. VRS-F	Ref. No. VRS
VRS-1/4"-20UNC	0.1	-	0.24	28	9	7	20	23	28	13	37	9	1/4"-20UNC	1/4"	5	-	7999105
VRS-F 5/16"-18UNC	0.3	0.13	-	35	11	9	25	25	30	16.3	47	12	5/16"-18UNC	1/4"	10	7999106	-
VRS-F / VRS-3/8"-16UNC	0.4	0.12	0.11	35	11	9	25	25	30	16.3	47	15	3/8"-16UNC	1/4"	10	7104480	7103959
VRS-F - / VRS-7/16"-14UNC	0.4	0.12	0.1	35	11	9	25	25	30	16.3	47	15	7/16"-14UNC	1/4"	10	7904195	7903118
VRS-F - / VRS-1/2"-13UNC	0.75	0.22	0.2	42	13	10	30	30	34	19.8	56	19	1/2"-13UNC	5/16"	25	7104481	7103960
VRS-F - / VRS-5/8"-11UNC	1.5	0.35	0.54	49	15	13	35	36	40	23.5	65	24	5/8"-11UNC	3/8"	60	7104482	7103961
VRS-F - / VRS-3/4"-10UNC	1.5	0.58	0.35	58	17	16	40	41	50	29.5	76	30	3/4"-10UNC	1/2"	115	7104483	7103962
VRS-F - / VRS-7/8"-9UNC	2.3	0.61	0.7	58	17	16	40	41	50	29.5	76	33	7/8"-9UNC	1/2"	115	7104484	7103963
VRS-F - / VRS-1"-8UNC	3.2	1.04	0.97	70	20	19	49	51	60	35	92	38	1"-8UNC	9/16"	190	7104485	7103964
VRS-F - / VRS-1 1/8"-8UN	3.2	1.08	1	70	20	19	49	51	60	35	92	36	1 1/8"-8UN	9/16"	250	7903386	7999385
VRS-F - / VRS-1 1/8"-7UNC	3.2	1.08	1	70	20	19	49	51	60	35	92	36	1 1/8"-7UNC	9/16"	250	7903383	7999384
VRS-F - / VRS-1 1/4"-7UNC	4.5	2.08	1.95	87	26	24	60	66	75	44	114	48	1 1/4"-7UNC	3/4"	330	7104486	7103965
VRS-F - / VRS-1 1/2"-6UNC	7	3.6	2.9	104	32	29	73	76	98	53	135	54	1 1/2"-6UNC	7/8"	590	7104487	7103966
VRS-F - / VRS-1 3/4"-5UNC	9	4.95	4.6	122	36	34	85	86	109	62	158	63	1 3/4"-5UNC	1"	925	7104488	7103967
VRS-F-2"-4.5UNC	12	7.6	7	138	42	38	96	101	128	70	180	72	2"-4.5UNC	1 1/8"	1.400	7104489	7103968

Subject to technical changes!

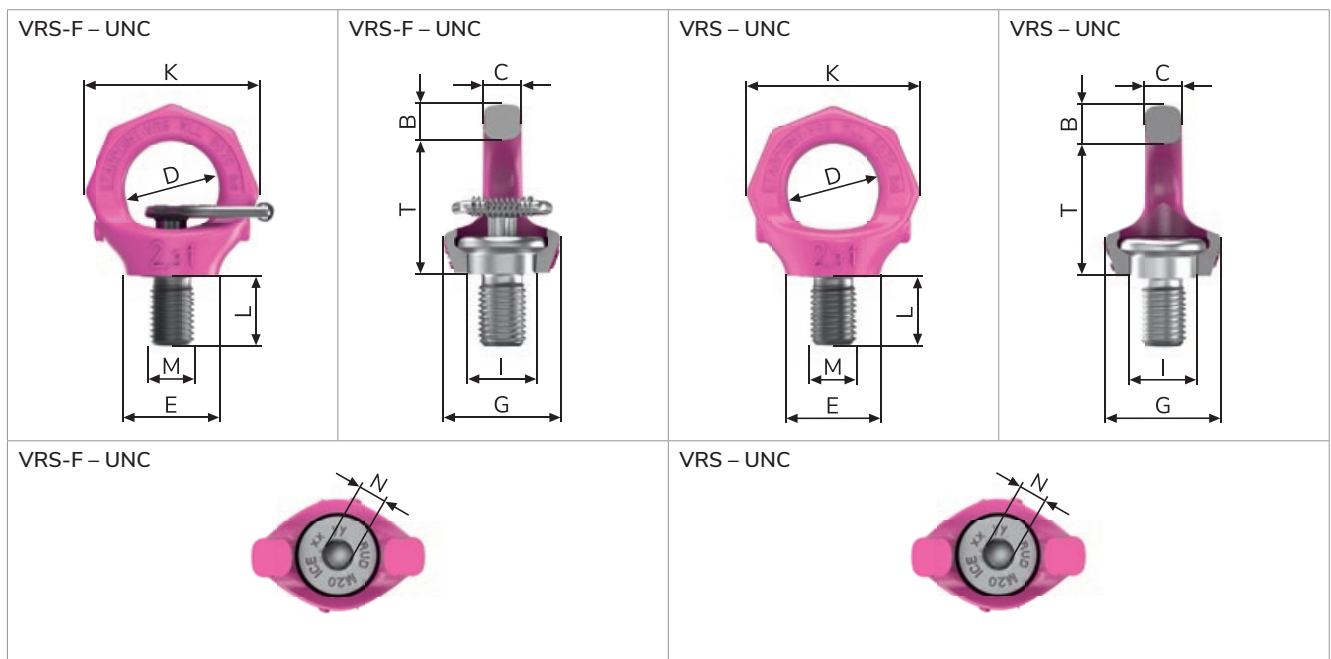

VRS

Star profile key / socket key.

VRS-STAR PROFILE KEY – METRIC.

Type	Weight (kg/unit)	A [mm]	B [mm]	D [mm]	N [mm]	M	Ref. No.
Star profile key, width across flats 6	0.02	-	-	-	6	M6 + M8 + M10	7983986
Star profile key, width across flats 8	0.02	-	-	-	8	M12 + M14	7905453
Star profile key, width across flats 10	0.03	-	-	-	10	M16 + M18	7903254
Star profile key, width across flats 12	0.04	-	-	-	12	M20 + M22	7904282
Star profile key, width across flats 14	0.08	-	-	-	14	M24 + M27	7904283
Star profile key, width across flats 17	0.12	-	-	-	17	M30 + M33	7904284
Star profile key, width across flats 22	0.15	-	-	-	22	M36	7904285
Star profile key, width across flats 24	0.3	-	-	-	24	M42	7904286
Star profile key, width across flats 27	0.4	-	-	-	27	M48	7904287
Star profile key, width across flats 32	1.1	-	-	-	32	M56	7911045
Star profile key, width across flats 36	1.3	-	-	-	36	M64	7911046

Subject to technical changes!

VRS-STAR PROFILE KEY – UNC INCH THREAD.

Type	Weight (kg/unit)	A [mm]	B [mm]	D [mm]	N ["]	M	Ref. No.
Star profile key, width across flats 1/4"	0.02	-	-	-	1/4	5/16"-18UNC + 3/8"-16UNC + 7/16"-14UNC	7983995
Star profile key, width across flats 5/16"	0.02	-	-	-	5/16	1/2"-13UNC	7983996
Star profile key, width across flats 3/8"	0.03	-	-	-	3/8	5/8"-11UNC	7983997
Star profile key, width across flats 1/2"	0.04	-	-	-	1/2	3/4"-10UNC + 7/8"-9UNC	7983998
Star profile key, width across flats 9/16"	0.08	-	-	-	9/16	1"-8UNC + 1 1/8"-8UNC + 1 1/8"-7UNC	7983999
Star profile key, width across flats 5/8"	0.12	-	-	-	5/8	1 1/4"-7UNC	7984000
Star profile key, width across flats 7/8"	0.15	-	-	-	7/8	1 1/2"-6UNC	7984001
Star profile key, width across flats 1"	0.3	-	-	-	1	1 3/4"-5UNC	7984002
Star profile key, width across flats 1 1/8"	0.4	-	-	-	1 1/8	2"-4.5UNC	7984003

Subject to technical changes!

VRS SOCKET KEY.

Type	Weight (kg/unit)	A [mm]	B [mm]	D	N [mm]	M	Ref. No.
Socket key, width across flats 6	0.09	118	7.5	1/2"	6	M6 + M8 + M10	7997749
Socket key, width across flats 8	0.11	118	9	1/2"	8	M12 + M14	7997750
Socket key, width across flats 10	0.15	138	12	1/2"	10	M16 + M18	7997751
Socket key, width across flats 12	0.2	137	14	1/2"	12	M20 + M22	7997752
Socket key, width across flats 14	0.24	140	16.5	1/2"	14	M24 + M27	7997753
Socket key, width across flats 17	0.47	152	22	3/4"	17	M30 + M33	7902078
Socket key, width across flats 22	1	192	26	1"	22	M36	7902079
Socket key, width across flats 24	1.2	276	29	1"	24	M42	7902080
Socket key, width across flats 27	2	304	33	1"	27	M48	7902081
Socket key, width across flats 32	2.4	324	38	32 mm	16	M56	7908744
Socket key, width across flats 36	3.1	324	43	36 mm	20	M64	7907745

Subject to technical changes!

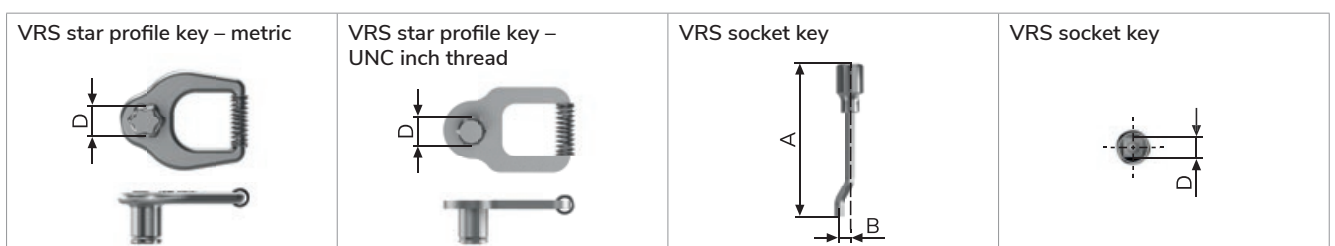



VRM-STARPOINT

VARIO eye nut.



PRODUCT FEATURES

- Large WLL range 0.1 t–4.5 t.
- The WLL information corresponds with the min. WLL (worst case scenario) in all loading directions. Higher WLL by optimised attachment or application.
- Available as a standard metric thread M6–M30 (DIN EN 13).
- Rotatable through 360°.



<p>Rotatable through 360°.</p>	<p>Clear marking of the minimum WLL.</p>	<p>WLL Y</p> <p>WLL</p>	<p>WLL Z</p> <p>>2Y WLL</p>
--------------------------------	--	-------------------------	------------------------------------

VRM VIP-EYE NUT – METRIC.

Type	WLL [t]	Weight (kg/unit)	T [mm]	B [mm]	C [mm]	D [mm]	E [mm]	F [mm]	G [mm]	H [mm]	I [mm]	K [mm]	L [mm]	M	N [mm]	Ref. No.
VRM-M6	0.1	0.05	28	9	7	20	23	16	28	17	13	37	11	M6	9	7900786
VRM-M8	0.3	0.1	35	11	9	25	25	21	30	21	16.3	47	14	M8	12	7992989
VRM-M10	0.4	0.1	35	11	9	25	25	21	30	21	16.3	47	14	M10	12	7990311
VRM-M12	0.75	0.2	42	13	10	30	30	24	34	25	19.8	56	17	M12	14	7990312
VRM-M16	1.5	0.3	49	15	13	35	36	30	40	31	23.6	65	21	M16	19	7990314
VRM-M20	2.3	0.5	58	17	16	40	41	37	50	35	29.3	76	23	M20	24	7990315
VRM-M24	3.2	0.9	70	20	19	49	51	45	60	41	35.2	92	29	M24	30	7990316
VRM-M30	4.5	1.5	87	26	24	60	66	56	75	51	44	114	36	M30	36	7993008

WLL values of VRM only apply in conjunction with thread bolts, which correspond with a minimum of quality class 10.9.

Subject to technical changes!

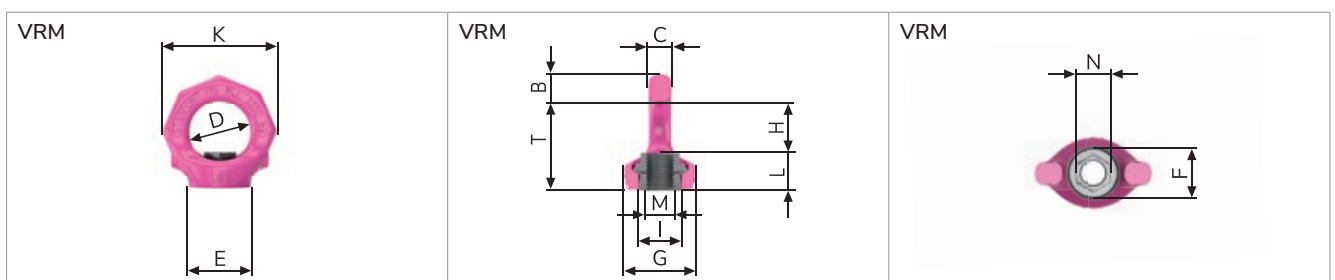

INOX-STAR



Stainless steel eye bolt.

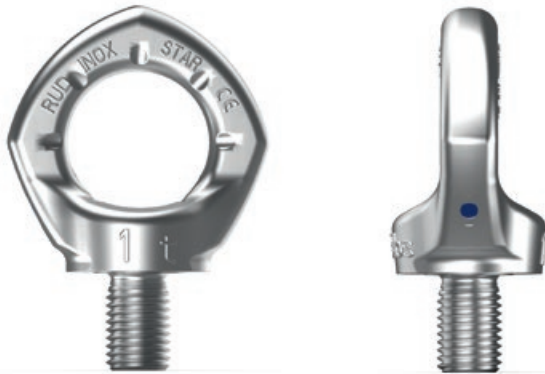

PRODUCT FEATURES

- Large WLL range 0.5 t–2.5 t.
- Non-removable special bolt and ring body made of duplex steel 1.4462.
- Variable bolt lengths for use in threaded and through holes.
- Fast and simple installation.
- High resistance in sea water or in environments with high concentration of chlorine ions.
- The penta shape clearly distinguishes it from conventional lifting points.
- Rotatable through 360°.
- Can be loaded from all sides.

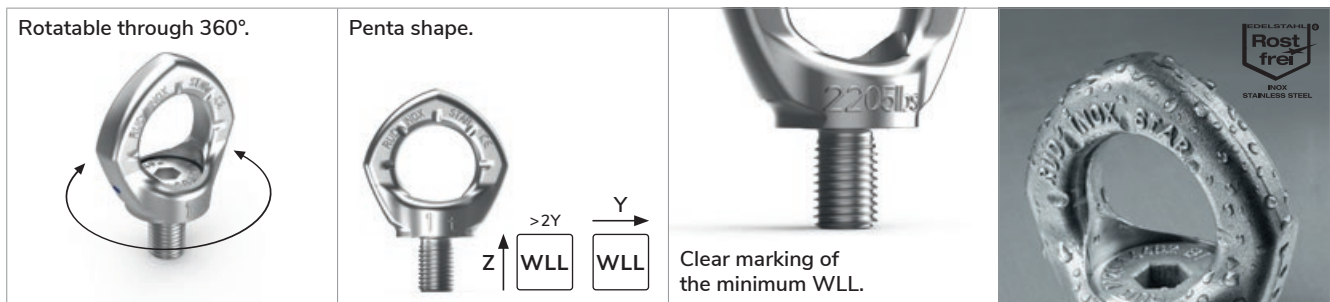

INOX-STAR STAINLESS EYEBOLT – METRIC.

Type	WLL [t]	Weight (kg/unit)	T [mm]	B [mm]	C [mm]	D [mm]	E [mm]	G [mm]	I [mm]	K [mm]	L [mm]	M	N [mm]	Tightening torque [Nm]	Ref. No.
INOX-STAR M12	0.5	0.19	43	14	12	30	30	32	20	56	18	M12	8	25	7993835
INOX-STAR M16	1	0.31	50	16	14	35	36	38	22	65	24	M16	10	60	7993836
INOX-STAR M20	2	0.53	58	19	16	40	43	47	27.5	74	30	M20	12	115	7993837
INOX-STAR M24	2.5	0.92	70	24	19	48	51	56	33	92	36	M24	14	190	7993838
INOX-STAR M12 L = 50	0.5	0.22	43	14	12	30	30	32	18	56	50	M12	8	25	7997822
INOX-STAR M16 L = 50	1	0.35	50	16	14	35	36	38	22	65	50	M16	10	60	7910089
INOX-STAR M20 L = 60	2	0.6	58	19	16	40	43	47	27.5	74	60	M20	12	115	7998714

Subject to technical changes!

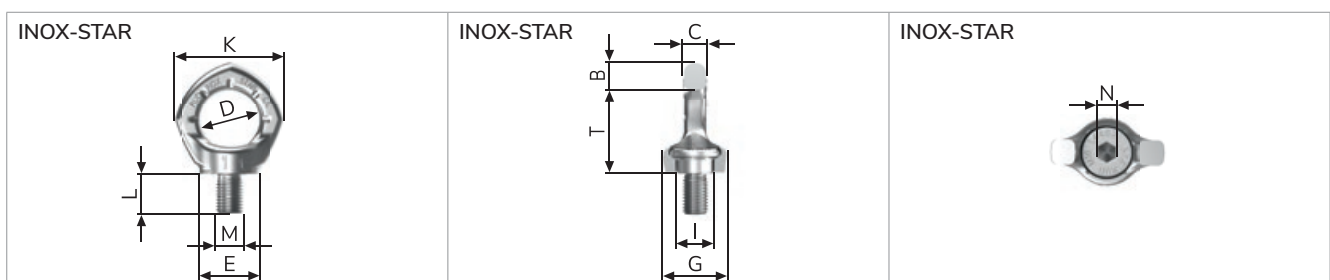

VWBM



Swivel hoist ring metric – with internal thread.



PRODUCT FEATURES

- Rotatable lifting point with internal thread.
- Rotatable 90° to the bolt-on direction under rated WLL.
- Large clearance between the bolt-on surface and load to prevent damage.
- Fast and simple installation.



<p>VWBM</p>	<p>Internal thread.</p>	<p>Clear marking of the minimum WLL.</p>
	<p>Patented wear markings. Ready to be discarded. New.</p>	

- Pivots 180°, rotates 360°.
- Ball bearing for shock-free and less friction when rotating and turning.
- Optical markings for angle and wear adjustment.

VWBM

Metric thread.

VWBM – METRIC.

Type	WLL [t]	Weight (kg/unit)	A [mm]	B [mm]	C [mm]	D [mm]	E [mm]	F [mm]	G [mm]	H [mm]	M [mm]	T [mm]	Tightening torque [Nm]	Ref. No.
VWBM 0.6tM12	0.6	0.6	10	49	35	41	36	15	62	21	12	122	80	7909682
VWBM 1.0tM16	1	0.9	13	46	38	46	41	20	73	27	16	131	150	7909683
VWBM 1.8tM20	1.8	1.8	13	54	35	62	55	25	88	34	20	158	240	7911439

Subject to technical changes!

VWBM – metric

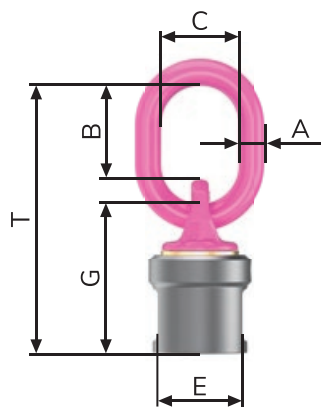

VWBM – metric

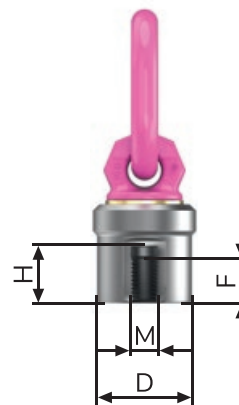

RS / RM

Eye bolt / eye nut.

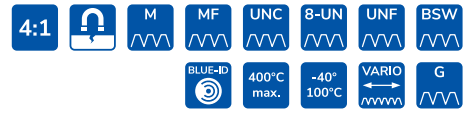

(1)

RUD RFID
CONNECT IT 

PRODUCT FEATURES

- Large WLL range 0.1 t–8 t.
- Much higher WLL (in comparison to DIN 580/582) with vertical load.
- Wide range of threads: M, MF, UNC, UNF, 8UN, BSW, G.
- Clear indication of the minimum WLL for all loading directions.
- Fast and simple installation.



RS (1)



RM

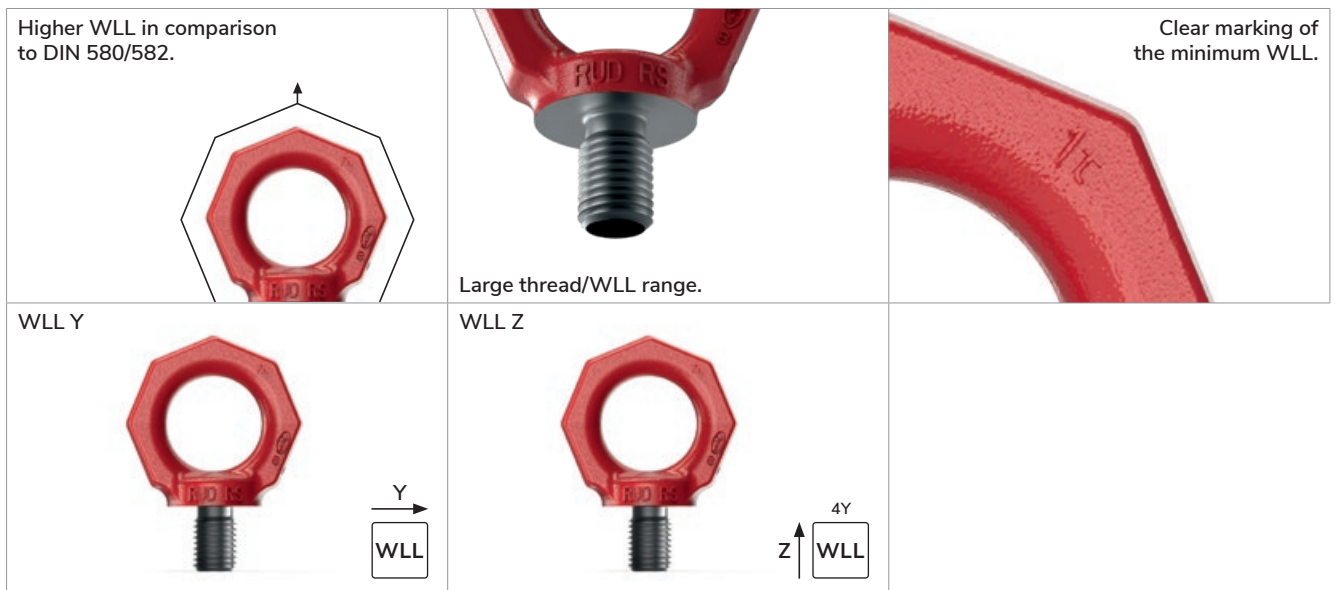

RS

Metric thread.

RS – METRIC THREAD.

Type	WLL [t]	Weight (kg/unit)	T [mm]	A [mm]	B [mm]	C [mm]	D [mm]	E [mm]	M	Ref. No.
RS M6	0.1	0.1	34	12	11	10	25	25	M6	61401
RS M8	0.2	0.1	34	12	11	10	25	25	M8	61402
RS M10	0.25	0.1	34	15	11	10	25	25	M10	56397
RS M12	0.4	0.18	41	18	13	12	30	30	M12	56398
RS M14	0.75	0.3	48	21	15	14	35	35	M14	56403
RS M16	1	0.3	48	24	15	14	35	35	M16	56404
RS M18	1.2	0.4	55	30	17	16	40	40	M18	53850
RS M20	1.5	0.47	55	30	17	16	40	40	M20	56407
RS M22	1.5	0.65	70	36	21	20	50	50	M22	53346
RS M24	2	0.88	70	36	21	20	50	50	M24	56408
RS M27	2	1.6	85	45	26	24	60	60	M27	53347
RS M30	3	1.62	85	45	26	24	60	60	M30	56409
RS M33	3	6.1	130	50	43	38	90	100	M33	57770
RS M36	4	6.3	130	54	43	38	90	100	M36	56954
RS M39	5	6.4	130	59	43	38	90	100	M39	57771
RS M42	6	6.5	130	63	43	38	90	100	M42	56955
RS M45	7	6.6	130	67	43	38	90	100	M45	58044
RS M48	8	6.7	130	67	43	38	90	100	M48	56956

Subject to technical changes!

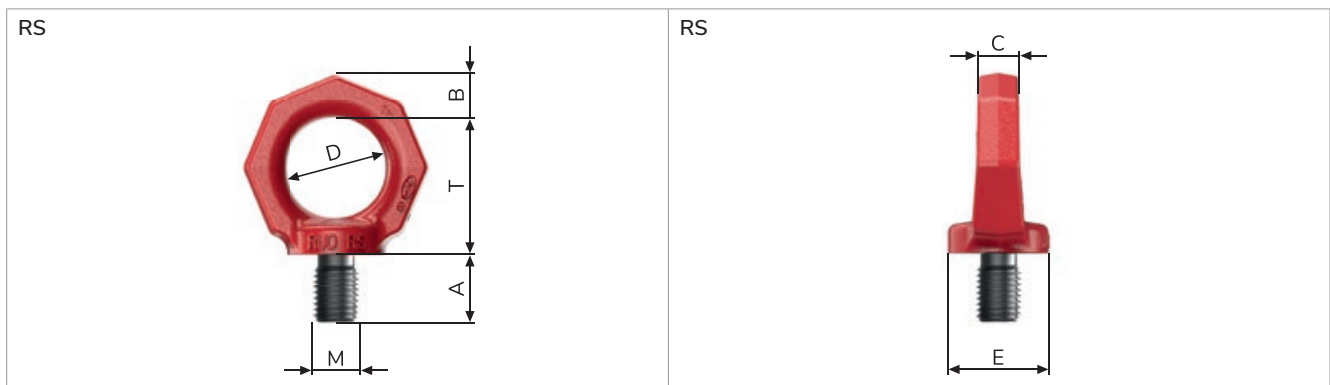

Special lengths up to 900 mm possible on request 8600625.

RS

Metric fine thread / pipe thread ISO 228-1.

RS – METRIC FINE THREAD.

Type	WLL [t]	Weight (kg/unit)	T [mm]	A [mm]	B [mm]	C [mm]	D [mm]	E [mm]	M	Ref. No.
RS M10 x 1	0.25	0.1	34	15	11	10	25	25	M10 x 1	7985047
RS M10 x 1.25	0.25	0.1	34	15	11	10	25	25	M10 x 1.25	56877
RS M12 x 1	0.4	0.18	41	18	13	12	30	30	M12 x 1	56868
RS M12 x 1.25	0.4	0.18	41	18	13	12	30	30	M12 x 1.25	56869
RS M12 x 1.5	0.4	0.18	41	18	13	12	30	30	M12 x 1.5	59830
RS M14 x 1.5	0.75	0.3	48	21	15	14	35	35	M14 x 1.5	53844
RS M16 x 1.5	1	0.3	48	24	15	14	35	35	M16 x 1.5	59832
RS M18 x 1.5	1.2	0.45	55	30	17	16	40	40	M18 x 1.5	50986
RS M20 x 1.5	1.5	0.47	55	30	17	16	40	40	M20 x 1.5	57203
RS M20 x 2	1.5	0.47	55	30	17	16	40	40	M20 x 2	59833
RS M22 x 1.5	1.5	0.78	70	34	21	20	50	50	M22 x 1.5	7901656
RS M24 x 1.5	2	0.88	70	36	21	20	50	50	M24 x 1.5	57210
RS M24 x 2	2	0.88	70	36	21	20	50	50	M24 x 2	59834
RS M27 x 2	2	1.6	85	45	26	24	60	60	M27 x 2	57259
RS M30 x 2	3	1.6	85	45	26	24	60	60	M30 x 2	59835
RS M36 x 3	4	6.3	130	54	43	38	90	100	M36 x 3	53853
RS M42 x 3	6	6.5	130	63	43	38	90	100	M42 x 3	53872
RS M48 x 3	8	6.7	130	67	43	38	90	100	M48 x 3	53885

Subject to technical changes!

RS – PIPE THREAD ISO 228-1.

Type	WLL [t]	Weight (kg/unit)	T [mm]	A [mm]	B [mm]	C [mm]	D [mm]	E [mm]	M	Ref. No.
RS G 1/4"	0.4	0.18	41	18	13	12	30	30	G 1/4"	7986067
RS G 3/8"	1	0.45	55	24	17	16	40	40	G 3/8"	7986853
RS G 3/4"	2	1.6	85	40	26	24	60	60	G 3/4"	7989219

Subject to technical changes!

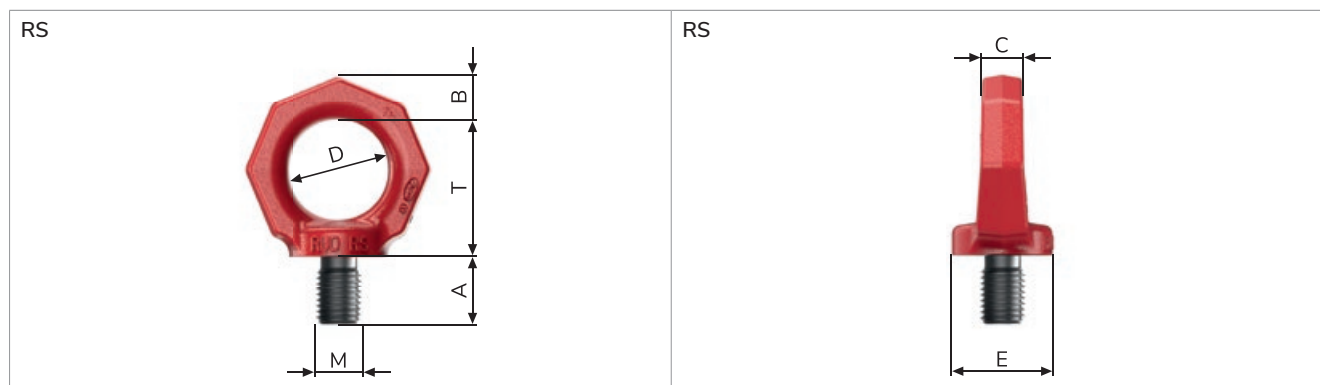

RS

UNC inch thread / UNC fine inch thread / BSW-Whitworth inch thread.

RS – UNC INCH THREAD.

Type	WLL [t]	Weight (kg/unit)	T [mm]	A [mm]	B [mm]	C [mm]	D [mm]	E [mm]	M	Ref. No.
RS 1/4"-20UNC	0.1	0.1	34	12	11	10	25	25	1/4"-20UNC	56887
RS 5/16"-18UNC	0.2	0.1	34	12	11	10	25	25	5/16"-18UNC	56885
RS 3/8"-16UNC	0.25	0.1	34	15	11	10	25	25	3/8"-16UNC	56879
RS 7/16"-14UNC	0.4	0.18	41	18	13	12	30	30	7/16"-14UNC	56870
RS 1/2"-13UNC	0.4	0.18	41	18	13	12	30	30	1/2"-13UNC	56871
RS 9/16"-12UNC	0.75	0.3	48	22	15	14	35	35	9/16"-12UNC	57120
RS 5/8"-11UNC	1	0.3	48	24	15	14	35	35	5/8"-11UNC	57198
RS 3/4"-10UNC	1.2	0.47	55	30	17	16	40	40	3/4"-10UNC	57205
RS 7/8"-9UNC	1.5	0.8	70	34	21	20	50	50	7/8"-9UNC	57212
RS 1"-8UNC	2	0.85	70	36	21	20	50	50	1"-8UNC	57213
RS 1 1/8"-7UNC	2.5	1.6	85	45	26	24	60	60	1 1/8"-7UNC	57471
RS 1 1/8"-8UN	2.5	1.6	85	45	26	24	60	60	1 1/8"-8UN	7985010
RS 1 1/4"-7UNC	3	1.6	85	46	26	24	60	60	1 1/4"-7UNC	57685
RS 1 1/4"-8UN	3	1.6	85	46	26	24	60	60	1 1/4"-8UN	57686
RS 1 3/8"-6UNC	3	6.1	130	55	43	38	90	100	1 3/8"-6UNC	58599
RS 1 1/2"-6UNC	4	6.2	130	58	43	38	90	100	1 1/2"-6UNC	58615
RS 1 3/4"-5UNC	6	6.3	130	67	43	38	90	100	1 3/4"-5UNC	58616
RS 2"-4.5UNC	8	6.5	130	67	43	38	90	100	2"-4.5UNC	58658

Subject to technical changes!

RS – UNF FINE INCH THREAD.

Type	WLL [t]	Weight (kg/unit)	T [mm]	A [mm]	B [mm]	C [mm]	D [mm]	E [mm]	M	Ref. No.
RS 3/8"-24UNF	0.25	0.1	34	15	11	10	25	25	3/8"-24UNF	56881
RS 7/16"-20UNF	0.4	0.18	41	18	13	12	30	30	7/16"-20UNF	56872
RS 1/2"-20UNF	0.4	0.18	41	18	13	12	30	30	1/2"-20UNF	56873
RS 5/8"-18UNF	1	0.3	48	24	15	14	35	35	5/8"-18UNF	57199
RS 3/4"-16UNF	1.2	0.47	55	30	17	16	40	40	3/4"-16UNF	57204
RS 1"-12UNF	2	0.85	70	36	21	20	50	50	1"-12UNF	57215

Subject to technical changes!

RS – BSW-WHITWORTH INCH THREAD.

Type	WLL [t]	Weight (kg/unit)	T [mm]	A [mm]	B [mm]	C [mm]	D [mm]	E [mm]	M	Ref. No.
RS 3/8"-BSW	0.25	0.1	34	15	11	10	25	25	3/8"-BSW	51808
RS 1/2"-BSW	0.4	0.18	41	18	13	12	30	30	1/2"-BSW	51810
RS 5/8"-BSW	1	0.3	48	24	15	14	35	35	5/8"-BSW	51811
RS 3/4"-BSW	1.2	0.45	55	30	17	16	40	40	3/4"-BSW	51813
RS 7/8"-BSW	1.5	0.8	70	34	21	20	50	50	7/8"-BSW	51816
RS 1"-BSW	2	0.85	70	36	21	20	50	50	1"-BSW	51774
RS 1 1/8"-BSW	3	1.6	85	45	26	24	60	60	1 1/8"-BSW	51775
RS 1 1/4"-BSW	3	1.6	85	45	26	24	60	60	1 1/4"-BSW	51776
RS 1 1/2"-BSW	4	6.2	130	58	43	38	90	100	1 1/2"-BSW	51779
RS 1 3/4"-BSW	6	6.3	130	67	43	38	90	100	1 3/4"-BSW	51803
RS 2"-BSW	8	6.8	130	67	43	38	90	100	2"-BSW	51805

Subject to technical changes!

RM

Metric thread / metric fine thread / pipe thread ISO 228-1.

RM – METRIC THREAD.

Type	WLL [t]	Weight (kg/unit)	T [mm]	A [mm]	B [mm]	C [mm]	D [mm]	E [mm]	M	Ref. No.
RM M6	0.1	0.1	34	11	11	10	25	25	M6	55254
RM M8	0.2	0.1	34	11	11	10	25	25	M8	55255
RM M10	0.25	0.1	34	11	11	10	25	25	M10	55258
RM M12	0.4	0.16	41	12	13	12	30	30	M12	55271
RM M14	0.75	0.26	48	13	15	14	35	35	M14	55281
RM M16	0.8	0.26	48	13	15	14	35	35	M16	55460
RM M18	1.2	0.4	55	16	17	16	40	40	M18	55342
RM M20	1.5	0.4	55	16	17	16	40	40	M20	55343
RM M22	1.5	0.7	70	20	21	20	50	50	M22	55387
RM M24	2	0.7	70	20	21	20	50	50	M24	55394
RM M27	2	1.35	85	25	26	24	60	60	M27	55399
RM M30	3	1.32	85	25	26	24	60	60	M30	55438
RM M33	3	5.8	130	37	43	38	90	100	M33	7994437
RM M36	4	5.8	130	37	43	38	90	100	M36	53093
RM M39	5	5.6	130	37	43	38	90	100	M39	7904790
RM M42	6	5.5	130	37	43	38	90	100	M42	53095
RM M48	8	5.3	130	37	43	38	90	100	M48	53098

Subject to technical changes!

RM – METRIC FINE THREAD.

Type	WLL [t]	Weight (kg/unit)	T [mm]	A [mm]	B [mm]	C [mm]	D [mm]	E [mm]	M	Ref. No.
RM M14 x 1.5	0.75	0.26	48	13	15	14	35	35	M14 x 1.5	7902750
RM M16 x 1.5	0.8	0.26	48	13	15	14	35	35	M16 x 1.5	7906923
RM M18 x 1.5	1.2	0.4	55	16	17	16	40	40	M18 x 1.5	7902751
RM M22 x 1.5	1.5	0.7	70	20	21	20	50	50	M22 x 1.5	7906924
RM M24 x 2	2	0.7	70	20	21	20	50	50	M24 x 2	7907625
RM M27 x 2	2	1.35	85	25	26	24	60	60	M27 x 2	7901995
RM M48 x 3	8	5.3	130	37	43	38	90	100	M48 x 3	7995961

Subject to technical changes!

RM – PIPE THREAD ISO 228-1.

Type	WLL [t]	Weight (kg/unit)	T [mm]	A [mm]	B [mm]	C [mm]	D [mm]	E [mm]	M	Ref. No.
RM G 1/4"	0.4	0.16	41	14	13	12	30	30	G 1/4"	7998753
RM G 1/2"	1.5	0.39	55	18	17	16	40	40	G 1/2"	7998754
RM G 3/4"	2	0.74	70	22	21	20	50	50	G 3/4"	7998755

The WLL values of RM only apply in conjunction with thread bolts of quality class 8.8 min. Thread bolts 8.8 must be crack-tested.

Subject to technical changes!

RM

UNC inch thread / BSW-Whitworth inch thread.

RM – UNC INCH THREAD.

Type	WLL [t]	Weight (kg/unit)	T [mm]	A [mm]	B [mm]	C [mm]	D [mm]	E [mm]	M	Ref. No.
RM 3/8"-16UNC	0.2	0.1	34	12	11	10	25	25	3/8"-16UNC	7101103
RM 1/2"-13UNC	0.35	0.17	41	14	13	12	30	30	1/2"-13UNC	7101104
RM 5/8"-11UNC	0.75	0.29	48	16	15	14	35	35	5/8"-11UNC	7101105
RM 3/4"-10UNC	1.2	0.39	55	18	17	16	40	40	3/4"-10UNC	7101106
RM 7/8"-9UNC	1.5	0.7	70	22	21	20	50	50	7/8"-9UNC	7101107
RM 1"-8UNC	2	1.4	85	28	26	24	60	60	1"-8UNC	7101108
RM 1 1/4"-7UNC	3	1.35	85	28	26	24	60	60	1 1/4"-7UNC	7982594

Subject to technical changes!

RM – BSW-WHITWORTH INCH THREAD.

Type	WLL [t]	Weight (kg/unit)	T [mm]	A [mm]	B [mm]	C [mm]	D [mm]	E [mm]	M	Ref. No.
RM 1/2"-BSW	0.35	0.17	41	14	13	12	30	30	1/2"-BSW	7993984
RM 5/8"-BSW	0.75	0.3	48	16	15	14	35	35	5/8"-BSW	7993985
RM 3/4"-BSW	1.2	0.42	55	18	17	16	40	40	3/4"-BSW	7993986
RM 7/8"-BSW	1.5	0.7	70	22	21	20	50	50	7/8"-BSW	7993988
RM 1"-BSW	2	0.7	70	22	21	20	50	50	1"-BSW	7993989
RM 1 1/8"-BSW	2.5	1.3	85	28	26	24	60	60	1 1/8"-BSW	7994198

Subject to technical changes!

RM

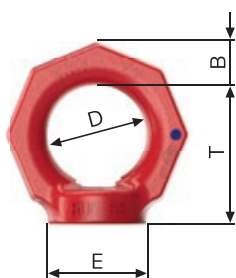

RM

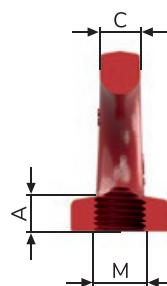

VABH-B



VIP-boltable attachment block.

RUD RFID
CONNECT IT 



PRODUCT FEATURES

- Large WLL range 1.5 t–6.7 t.
- For combination with all conventional lifting means without additional connecting elements.
- ICE-Bolt made from patented steel. Improved toughness meaning higher bending strength and lower wear occurrence.
- Patented wear markings for easy determination of wear.
- Robust forged safety latch.

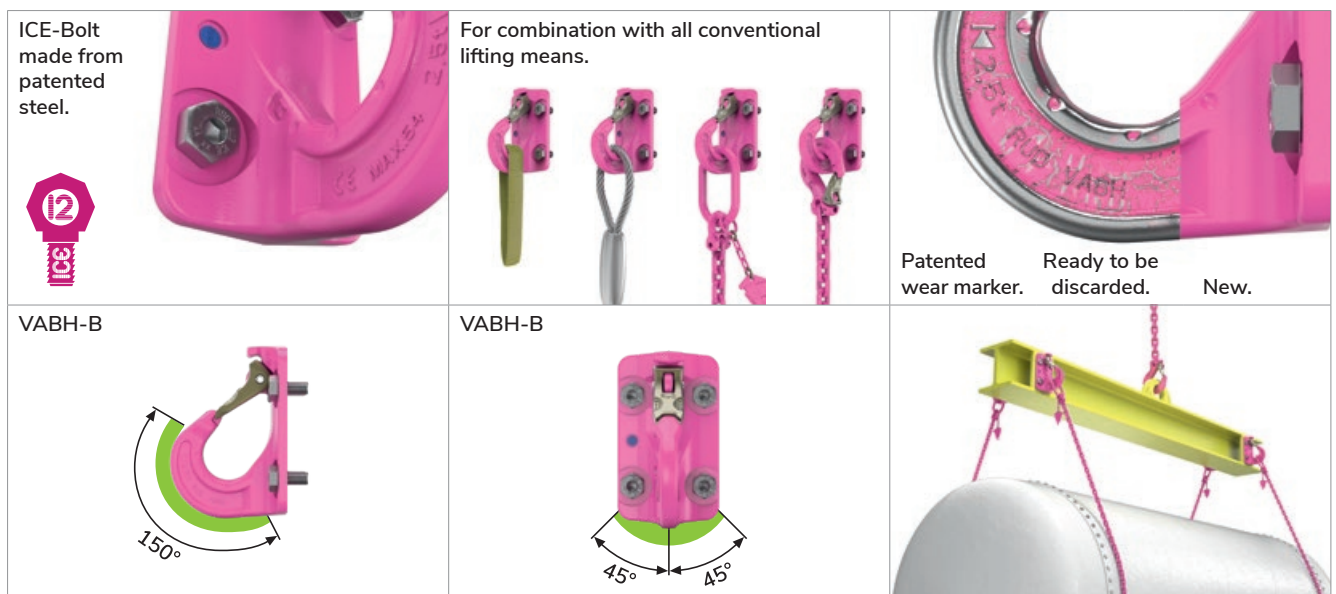

✓ Corresponds with the test criteria of BG/DGUV "GS-OA-15-04".

- As a lifting point on trusses and beams.
- For ropes and round slings.
- For lifting means with eye or oval ring.

VABH-B

Metric thread.

VABH-B – VIP-BOLTABLE ATTACHMENT BLOCK – METRIC.

Type	WLL [t]	Weight (kg/unit)	T [mm]	A [mm]	B [mm]	C [mm]	D [mm]	E [mm]	F [mm]	G [mm]	H [mm]	I [mm]	L [mm]	M	Tightening torque [Nm]	Ref. No.
VABH-B 1.5 t	1.5	0.78	26	7.5	76	115	111	70	26	48	60	38	13.5	4 × M10	55	7991205
VABH-B 2.5 t	2.5	1.73	33	8.5	98	148	143	85	31.5	60	75	49	18	4 × M12	100	7991206
VABH-B 4 t	4	3	40	11	119	168	164	104	35	70	90	59	25	4 × M16	240	7991207
VABH-B 6.7 t	6.7	5.58	51	13	147	205	200	120	40	85	110	70	28	4 × M20	450	8502238

Subject to technical changes!

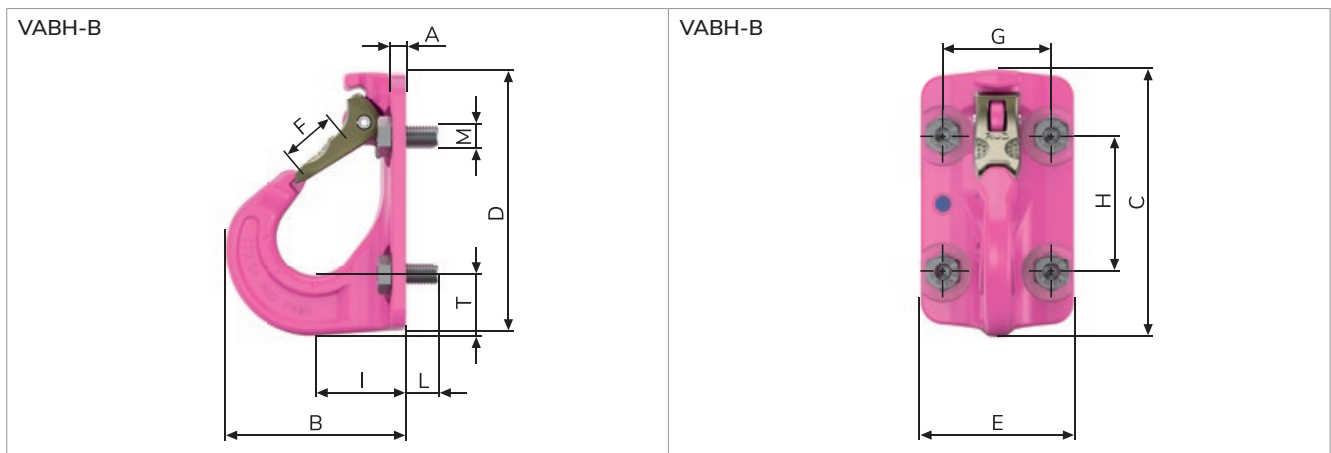

VCGH-G



VIP-boltable attachment block.



PRODUCT FEATURES

- Large WLL range 10 t, 16 t–20 t.
- For combination with all conventional lifting means without additional connecting elements.
- ICE-Bolt made from patented steel. Safe deep temperature usage; improved toughness meaning higher bending strength and lower wear occurrence.
- Patented wear markings for easy determination of wear.
- Robust forged safety latch.

<p>ICE-Bolt made from patented steel.</p>	<p>For combination with all conventional lifting means.</p>	<p>Patented wear marker. Ready to be discarded. New.</p>
<p>VCGH-G 16</p>	<p>VCGH-G 20/22</p>	

✓ Corresponds with the test criteria of BG/DGUV "GS-OA-15-04".

- As a lifting point on trusses and beams.
- For ropes and round slings.
- For lifting means with eye or oval ring.

VCGH-G

Metric thread.

VABH-G – VIP-BOLTABLE ATTACHMENT BLOCK – METRIC.

Type	WLL [t]	Weight (kg/unit)	T [mm]	A [mm]	B [mm]	C [mm]	D [mm]	E [mm]	F [mm]	G [mm]	H [mm]	I [mm]	L [mm]	M	Tightening torque [Nm]	Ref. No.
VCGH-G 16	10	8.49	49	15	141	200	220	170	48	120	150	69	35	4 × M24	800	7984048
VCGH-G 20	16	18	69	20	187	272	288	210	63	150	2 × 110	87	30	6 × M24	800	7984311
VCGH-G 22	20	18.9	74	20	196	276	292	240	63	150	2 × 110	92	30	6 × M24	950	7984313

Subject to technical changes!

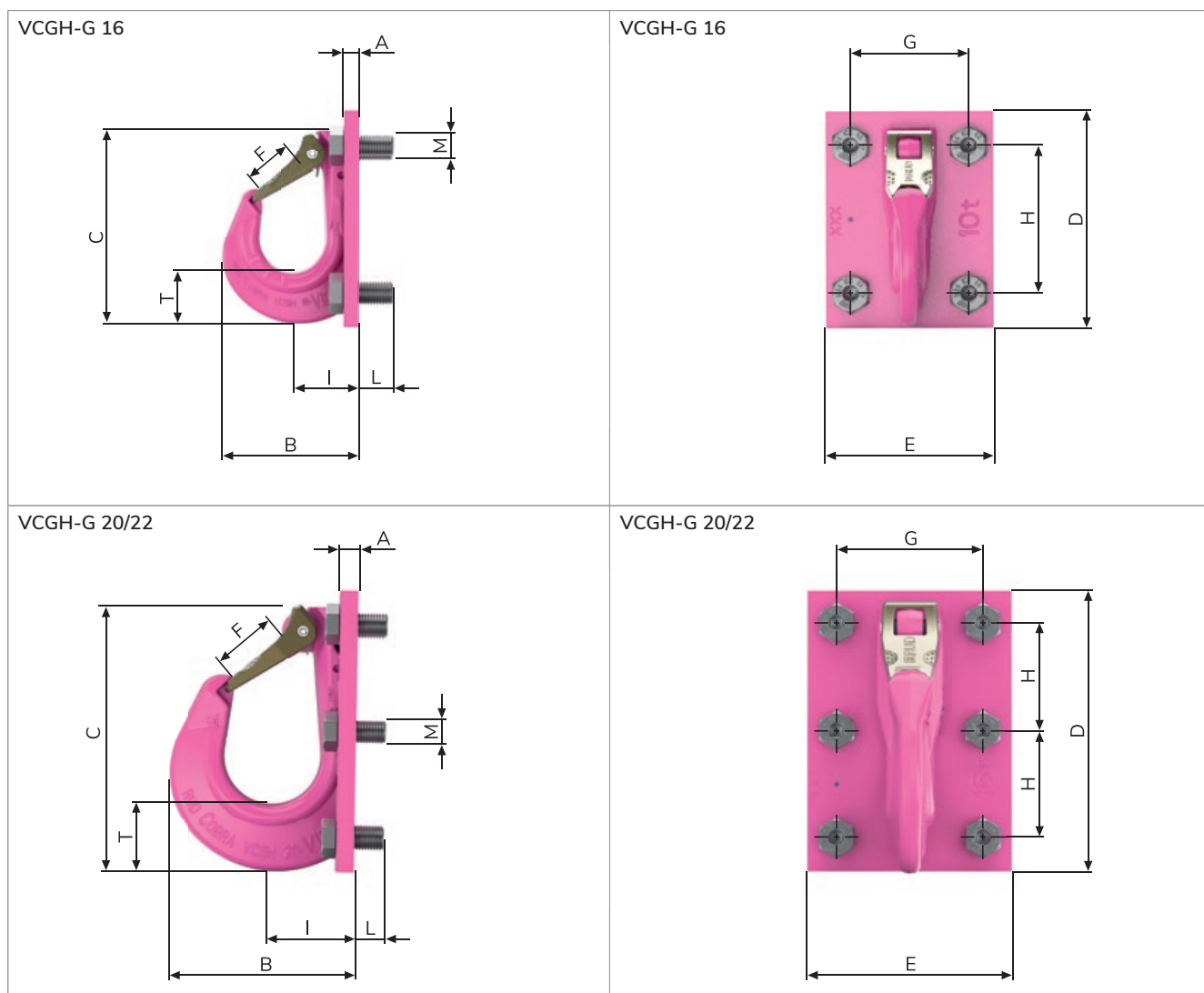

B-ABA



Lifting point that can be loaded on all sides.



PRODUCT FEATURES

- Large WLL range 1.6 t–31.5 t.
- No rattling noise or shaking even with strong vibrations or shocks loads, easy connection of the lifting means possible.
- ICE-Bolt made from patented steel. Safe deep temperature usage; improved toughness meaning higher bending strength and lower wear occurrence.
- Patented wear markings inside and out.
- Clear marking of the minimum WLL.



<p>No rattling noise or shaking.</p>	<p>ICE-Bolt made from patented steel.</p>	<p>Clear marking.</p>
<p>WLL X</p>	<p>WLL Y</p>	<p>WLL Z</p>



✓ Tested and certified by DGUV.
 Test criteria: GS-HM-36:2021-09
 Certificate no.: HM 220054

- Can be loaded from all sides.
- 4-times the safety against breakage.
- Tempered main body, making it more wear resistant.

B-ABA

Metric thread.

B-ABA – LIFTING POINT THAT CAN BE LOADED ON ALL SIDES.

Type	WLL [t]	Weight (kg/unit)	T [mm]	A [mm]	B [mm]	C [mm]	D [mm]	E [mm]	F [mm]	G [mm]	H [mm]	L [mm]	M	Tightening torque [Nm]	Ref. No.
B-ABA 1.6t	1.6	0.88	46.5	75	16	100	35	16	62.5	55	55	13	4×M10	55	7906266
B-ABA 3.2t	3.2	2	65	92	23	137	50	21	86	70	75	16	4×M12	100	7906267
B-ABA 5t	5	4.1	80	113	27	172	60	28	108	84	95	24	4×M16	240	7906268
B-ABA 10t	10	9.3	105	146	38	228	80	36	141	110	125	25	4×M20	450	7906269
B-ABA 20t	20	18.8	148	200	52	272	115	40	188	150	75	30	6×M24	800	7906270
B-ABA 31.5t	31.5	29.5	170	230	64	320	130	50	220	175	87.5	40	6×M30	950	7906271

Subject to technical changes!

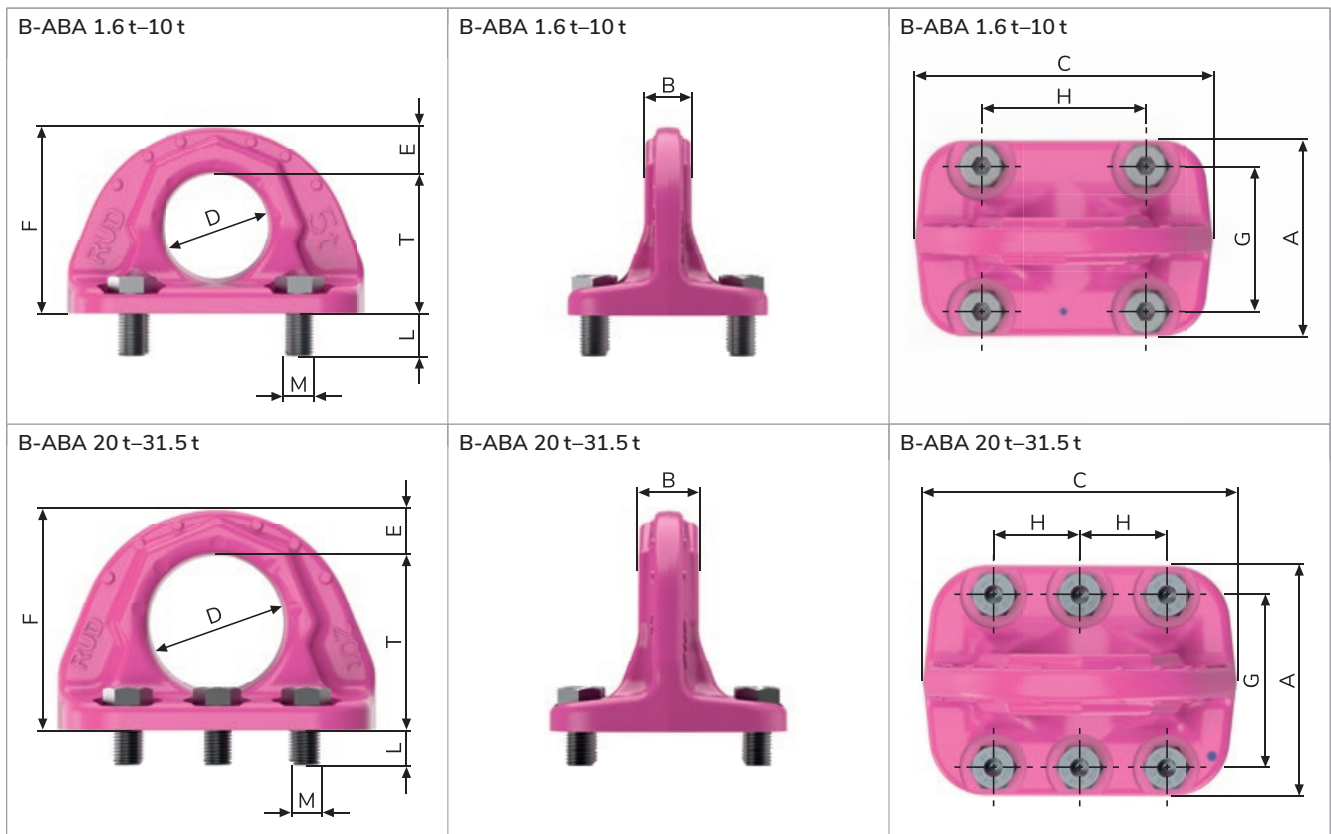

RBG / VRBG

Load ring thread / VIP-Load ring thread.

4:1 180° M -20° 100°C 350°C max. BLUE-ID

(1) (2)



PRODUCT FEATURES

- Large WLL range 3 t–16 t.
- Split force introduction thanks to multiple point fixing.
- Bracket can be pivoted through 180°.
- WLL possible up to 90° in load ring plane.
- Clear indication of the minimum WLL for all loading directions.



RBG 3 t (1)

VRBG 16 t (2)

<p>RBG 3 t 2 bolts.</p> <p>Also with vario-length.</p>	<p>VRBG 10 t / 16 t 4 bolts.</p>	<p>Patented wear marker.</p> <p>Ready to be discarded. New.</p>
<p>VRBG split force introduction.</p> <p>WLL possible up to 90° in load ring plane.</p>	<p>VRBG</p> <p>Can be pivoted through 180°.</p>	

✓ Corresponds with the test criteria of BG/DGUV "GS-OA-15-04".

- Split force introduction through several points, going easy on the component.
- WLL up to 16 t.

RBG / VRBG

Metric thread.

RBG 3 – LOAD RING THREAD.

Type	WLL [t]	Weight (kg/unit)	T [mm]	A [mm]	B [mm]	C [mm]	D [mm]	E [mm]	F [mm]	G [mm]	H [mm]	I [mm]	K [mm]	L [mm]	M	N [mm]	Tightening torque [Nm]	Ref. No.
RBG 3	3	1.07	67	34	16	5	48	22	92	6	18	30	1	178	2 x M16	71	120	51817
RBG 3-SL	3	¹	67	34	16	5	48	22	92	6	18	25-205	1	178	2 x M16	71	120	8600318

¹ Weight depends on the design.

Subject to technical changes!

VRBG 10 / 16 – VIP-LOAD RING THREAD.

Type	WLL [t]	Weight (kg/unit)	T [mm]	A [mm]	B [mm]	C [mm]	D [mm]	E [mm]	F [mm]	G [mm]	H [mm]	I [mm]	K [mm]	L [mm]	M	N [mm]	Tightening torque [Nm]	Ref. No.
VRBG 10	10	5.43	103	125	22	6	65	143	78	8	30	50	43	213	4 x M20	100	300	7994537
VRBG 16	16	11.3	131	170	30	8	90	198	104	10	46	70	63	270	4 x M30	134	600	7993255

Subject to technical changes!

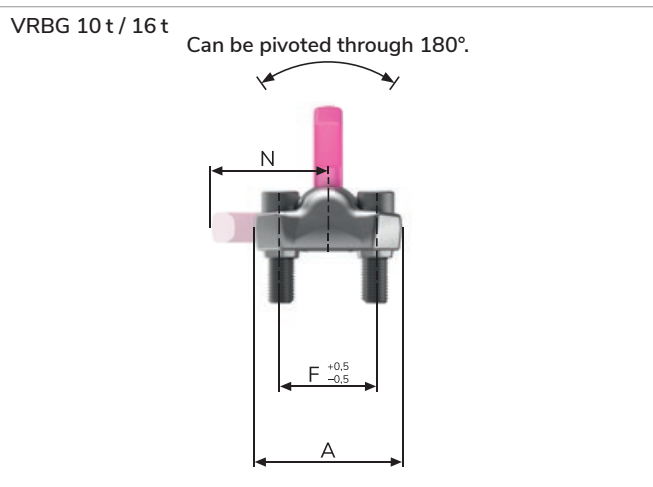
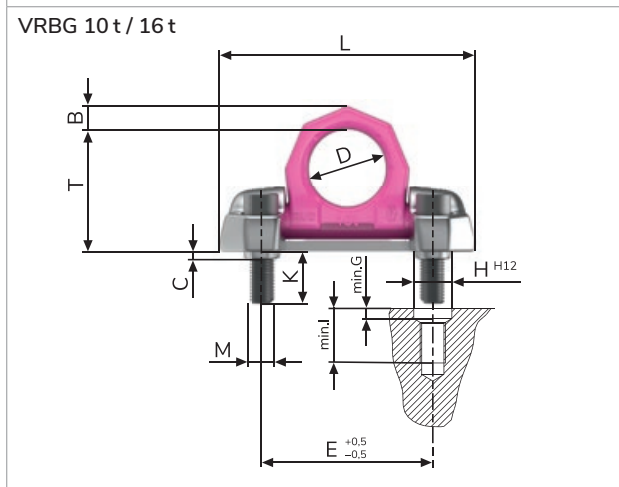
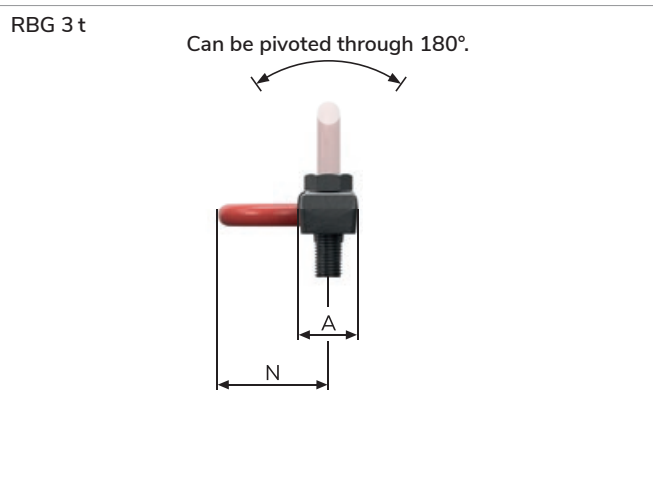
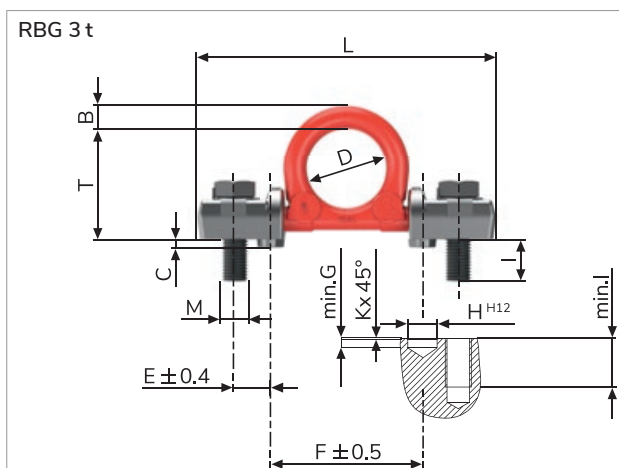

VRBG / VRBG-FIX

Load ring thread / VIP-Load ring thread FIX.

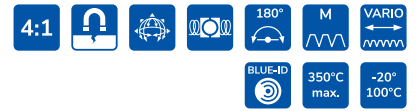

PRODUCT FEATURES

- Large WLL range 31.5 t–100 t.
- Split force introduction thanks to multiple point fixing.
- Suspension ring can be pivoted through 180°.
- WLL possible up to 90° in load ring plane.
- Clear indication of the minimum WLL for all loading directions.



VRBG 31.5t

VRBG-FIX 50t/VRBG-FIX 100t

<p>VRBG-FIX 31.5 t 6 bolts.</p> 	<p>VRBG-FIX 50 t 8 bolts.</p> 	<p>VRBG-FIX 100 t 8 bolts.</p> 
<p>VRBG split force introduction.</p>  <p>WLL possible up to 90° in load ring plane.</p>	<p>VRBG</p> <p>Can be pivoted through 180°.</p> 	<p>Patented wear marker.</p>  <p>Ready to be discarded. New.</p>

✓ Corresponds with the test criteria of BG/DGUV "GS-OA-15-04".

- Split force introduction through several points, going easy on the component.
- WLL up to 100 t.

VRBG / VRBG-FIX

Metric thread.

VRBG 31.5 t / VRBG-FIX 100 t – VIP-LOAD RING ON PLATE.

Type	WLL [t]	Weight (kg/unit)	T [mm]	A [mm]	B [mm]	C [mm]	D [mm]	E [mm]	F [mm]	K [mm]	L [mm]	M	N [mm]	Tightening torque [Nm]	Ref. No.
VRBG 31.5 t	31.5	66.3	265	180	42	42	130	75	120	46	400	6 × M30	195	900	7910387
VRBG-FIX 31.5 t	31.5	66.3	288	180	42	42	130	75	120	46	400	6 × M30	195	900	7910591
VRBG-FIX 50 t	50	204	430	270	70	55	230	100	200	60	650	8 × M36	335	1.000	7909951
VRBG-FIX 100 t	100	450	510	380	97	77	250	100	240	79	825	8 × M48	392	2000	7912696

Subject to technical changes!

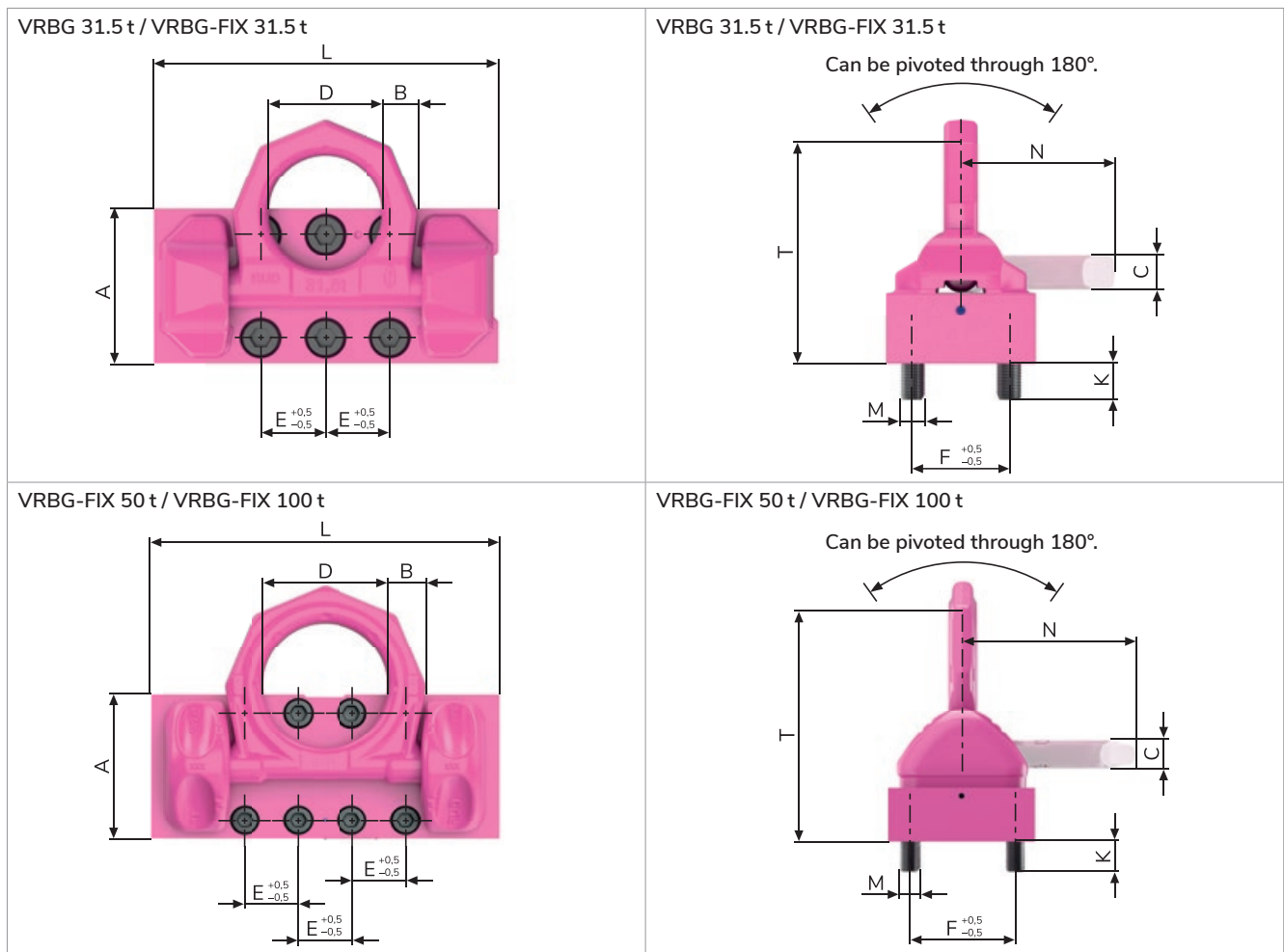

T-FRB / B-FRB



“FLARIBO” / flange load ring head flange /
flange load ring base flange.



T-FRB

B-FRB

PRODUCT FEATURES

- High flexibility! Ideal for use with different hole patterns and pitch circle diameters of flanges.
- Split force introduction thanks to multiple point fixing.
- Large clearance between the bolt-on surface and load to prevent damage.
- Patented wear markings for easy determination of wear.
- Variable bolt lengths for use in threaded and through holes.
- Equipped with an axial bushing disc for optimised 90° WLL.

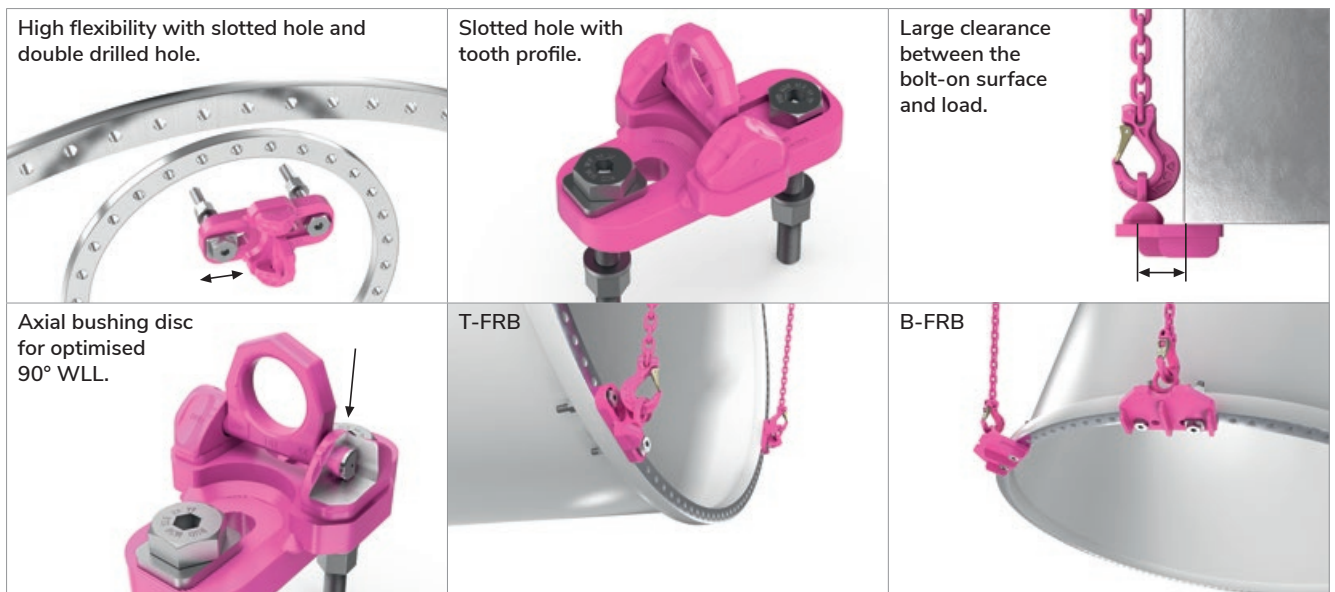

- High flexibility.
- Bracket can be pivoted through 180°.
- Or optimised 90° load.

T-FRB / B-FRB

Technical data.

T-FRB – FLANGE LOAD RING FLARIBO HEAD FLANGE.

Type	WLL [t]	Weight (kg/unit)	T [mm]	A [mm]	D [mm]	Possible thread	Ref. No.
T-FRB-F	max. 18	¹	214	150–400	90	M20, M24, M27, M30	8600170
T-FRB-G	max. 18	¹	228	160–320	90	M30, M36, M39, M42, M45, M48	8600180
T-FRB-H	max. 31.5	¹	307	180–390	130	M42, M45, M48, M56, M64	8600190

¹ Weight depends on the design.

Technological properties are recorded and evaluated order-specifically with the FLARIBO questionnaire, production is carried out on a customer-specific basis.

Subject to technical changes!

T-FRB – FLANGE LOAD RING FLARIBO HEAD FLANGE.

Type	WLL [t]	Weight (kg/unit)	T [mm]	A [mm]	D [mm]	Possible thread	Ref. No.
B-FRB-G	max. 18	¹	141	160–320	90	M30, M36, M39, M42, M45, M48	8600181
B-FRB-H	max. 31.5	¹	197	180–390	130	M42, M45, M48, M56, M64	8600191

¹ Weight depends on the design.

Technological properties are recorded and evaluated order-specifically with the FLARIBO questionnaire, production is carried out on a customer-specific basis.

Subject to technical changes!

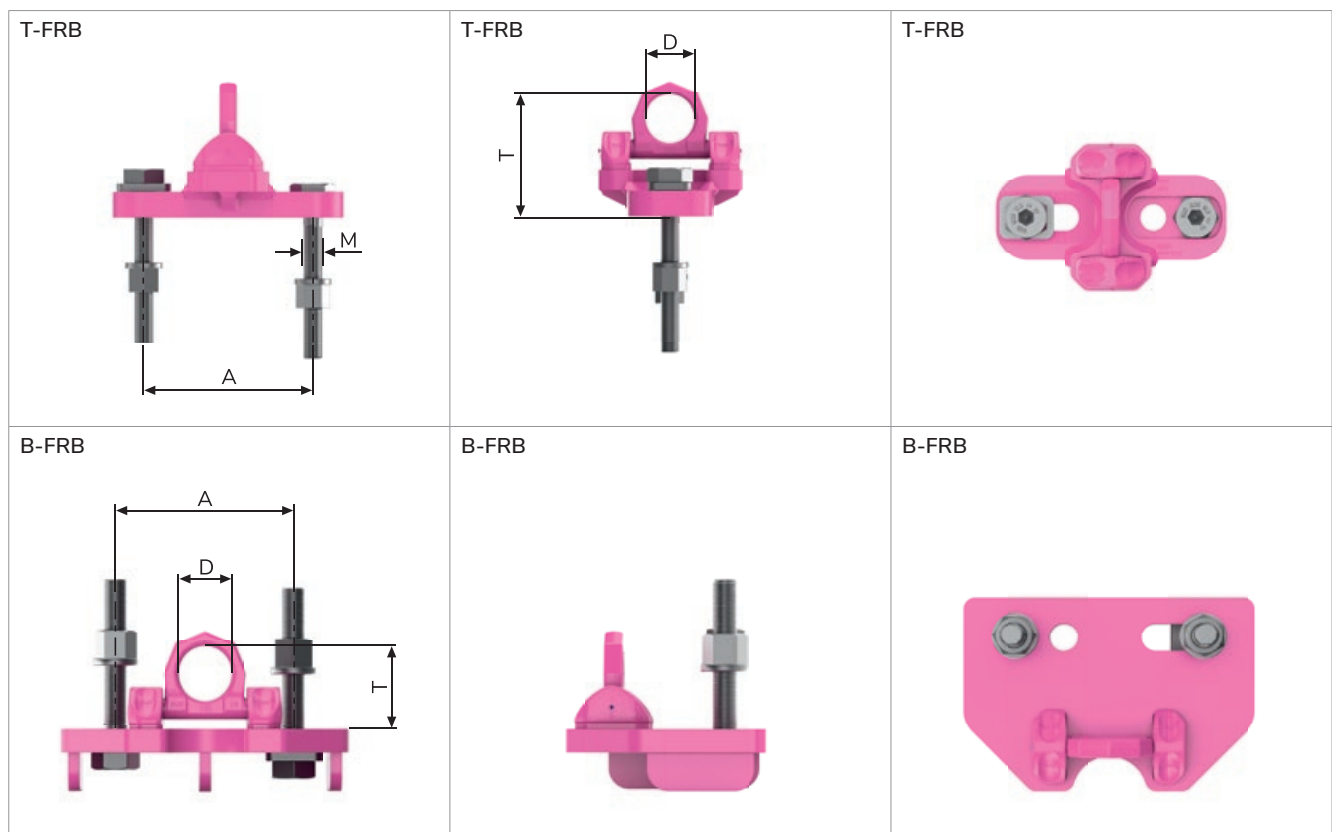

PSA-INOX-STAR / PSA-VRS-STARPOINT

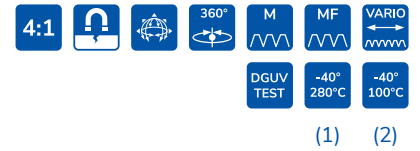

The life savers.

PRODUCT FEATURES

PSA-INOX-STAR:

- WLL range 1–2 persons.
- Ring body and bolt made from stainless steel.
- Non-removable special bolt.

PSA-VRS-STARPOINT:

- WLL range 1–2 persons.
- Non-removable special bolt.



PSA-INOX-STAR (1)

PSA-VRS-STARPOINT (2)



- ✓ In accordance with the EC Directive 89/686/EEC. Exceeds the requirements of DIN EN 795. Marking corresponds to DIN EN 365.
- ✓ Tested and certified by the PPE special division of DGVU.
- ✓ DGVU approval for fastening in steel and with blind rivet nut.

- PSA-INOX-STAR body and bolt made from stainless steel (1.4462).
- Rotatable through 360°.

PSA-INOX-STAR / PSA-VRS-STARPOINT

Metric thread.

PSA-INOX-STAR – METRIC.

Type	WLL [Persons]	Weight (kg/unit)	T [mm]	B [mm]	C [mm]	D [mm]	E [mm]	G [mm]	I [mm]	K [mm]	L [mm]	M	N [mm]	Ref. No.
PSA-INOX-STAR M12	1	0.19	43	14	12	30	30	32	18	56	18	M12	8	7997097
PSA-INOX-STAR M16	1-2	0.31	50	15	15	35	36	40	22	65	24	M16	10	7996757
PSA-INOX-STAR M20	1-2	0.56	58	19	17	40	43	47	27.5	74	30	M20	12	7900921
PSA-INOX-STAR M12 L = 50	1	0.22	43	14	12	30	30	32	18	56	50	M12	8	7997820
PSA-INOX-STAR M16 L = 50	1-2	0.4	50	15	15	35	36	40	22	65	50	M16	10	7904107
PSA-INOX-STAR M16 L = 120	1-2	0.47	50	15	15	35	36	40	22	65	120	M16	10	7909983
PSA-INOX-STAR M20 L = 60	1-2	0.6	57	19	17	40	43	47	27.5	74	60	M20	12	7901252

Subject to technical changes!

PSA-VRS-STARPOINT – METRIC.

Type	WLL [Persons]	Weight (kg/unit)	T [mm]	B [mm]	C [mm]	D [mm]	E [mm]	G [mm]	I [mm]	K [mm]	L [mm]	M	N [mm]	Ref. No.
PSA-VRS-STARPOINT M12	1	0.2	42	13	10	30	30	34	19.8	56	18	M12	8	7997100
PSA-VRS-STARPOINT M16	1-2	0.33	49	15	15	35	35	40	23.5	65	24	M16	10	7997854
PSA-VRS-STARPOINT M20	1-2	0.56	58	18	17	40	42	54	29.3	75	30	M20	12	7900920
PSA-VRS-STARPOINT M12 L = Sonderlänge	1	¹	42	13	10	30	30	34	19.8	56	19-150	M12	8	8600400
PSA-VRS-STARPOINT M16 L = Sonderlänge	1-2	¹	49	15	15	35	35	40	23.5	65	25-120	M16	10	8600401

¹ Weight depends on the design.

Subject to technical changes!

PSA-VRS-STARPOINT UNC INCH THREAD.

Type	WLL [Persons]	Weight (kg/unit)	T [mm]	B [mm]	C [mm]	D [mm]	E [mm]	G [mm]	I [mm]	K [mm]	L [mm]	M	N [mm]	Ref. No.
PSA-VRS-STARPOINT 1/2"-13UNC	1	0.2	42	13	10	30	30	34	19.8	56	18	1/2" 13UNC	5/16"	7997103
PSA-VRS-STARPOINT 5/8"-11UNC	1-2	0.32	49	15	15	35	35	40	23.5	65	24	5/8"-11UNC	3/8"	7998659
PSA-VRS-STARPOINT 3/4"-10UNC	1-2	0.56	58	18	17	40	42	54	29.3	75	30	3/4"-10UNC	1/2"	7903367



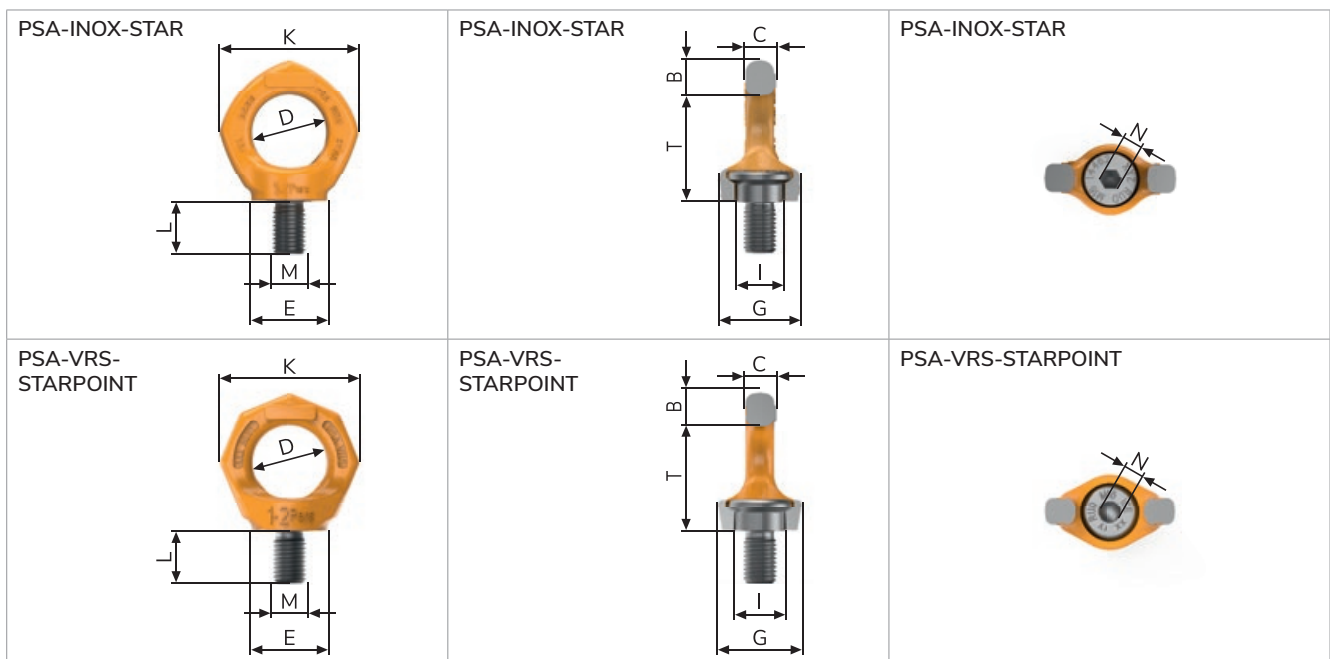



















Subject to technical changes!





WELDABLE
LIFTING POINTS.

OVERVIEW OF
WELDABLE LIFTING POINTS.

																
p. 102  VLBS / VLBS-U / VLBS-U-LT / VLBS-P 1.5t–16t			■		■	■	■			■	■	■		■	■	
p. 106  VRBS-FIX 4t–100t			■		■	■	■			■	■	■		■		
p. 108  VRBS 4t–31.5t			■		■	■				■	■	■				
p. 110  VRBK-FIX 4t–50t			■		■	■	■			■	■	■		■		
p. 112  W-ABA 0.8t–31.5t			■		■	■					■	■		■	■	
p. 114  VABH-W / VCGH-S 1.5t–20t			■		■						■	■				
p. 116  WPP(H)-S / -B / -VIP / -KA + VWBS / VWBS-KA 0.63t–8t	■	■	■		■	■		■	■	■	■					

VLBS / VLBS-U



VIP-weldable load ring /
VIP-load ring weldable-captive.

PRODUCT FEATURES

- Large WLL range 1.5 t – 16 t.
- Functionally optimised shape of the suspension ring for better support at side loading and protection of the clamping spring.
- Suspension ring can be pivoted through 180°.
- WLL possible up to 90° in load ring plane.
- The clamping spring achieves noise reduction and keeps the suspension ring in the desired position.
- Distance knobs on the weld-on block for the necessary distance for root welding.
- Bracket and weld-on block for VLBS-U is captive due to the retaining spring.



✓ Tested and certified by DGUV.

Test criteria: GS-OA-15-04: 2015-12
Certificate no.: OA 1951043

VLBS / VLBS-U

Technical data.

VLBS – VIP-LOAD RING FOR WELDING (WITHOUT CLAMPING SPRING).

Type	WLL [t]	Weight (kg/unit)	T [mm]	A [mm]	B [mm]	C [mm]	D [mm]	E [mm]	F [mm]	G [mm]	H [mm]	Welding seam	Ref. No.
VLBS 1.5t	1.5	0.35	65	33	66	25	38	40	14	33	14	HV5 + a3	7993115
VLBS 2.5t	2.5	0.53	75	36	77	27	45	47	16	40	14	HV7 + a3	7995346
VLBS 4t	4	0.76	83	42	87	31	51	52	18	46	16	HV8 + a3	7993116
VLBS 6.7t	6.7	1.9	117	61	115	44	67	73	24	60	22	HV12 + a4	7993117
VLBS 10t	10	2.76	126	75	129	55	67	71	26.5	60	26	HV16 + a4	7993118
VLBS 16t	16	7.1	176	96	192	70	100	106	40	90	26.5	HV25 + a6	7993041

Subject to technical changes!

VLBS-U – VIP-CAPTIVE WELD-ON LOAD RING (WITH CLAMPING SPRING).

Type	WLL [t]	Weight (kg/unit)	T [mm]	A [mm]	B [mm]	C [mm]	D [mm]	E [mm]	F [mm]	G [mm]	H [mm]	Welding seam	Ref. No.
VLBS-U 1.5t	1.5	0.35	65	33	66	25	38	40	14	33	14	HV5 + a3	7993035
VLBS-U 2.5t	2.5	0.53	75	36	77	27	45	47	16	40	14	HV7 + a3	7994830
VLBS-U 4t	4	0.76	83	42	87	31	51	52	18	46	16	HV8 + a3	7993036
VLBS-U 6.7t	6.8	1.9	117	61	115	44	67	73	24	60	22	HV12 + a4	7993037
VLBS-U 10t	10	2.76	126	75	129	55	67	71	26.5	60	26	HV16 + a4	7993040
VLBS-U 16t	16	7.1	176	96	192	70	100	106	40	90	26.5	HV25 + a6	7906640

Subject to technical changes!

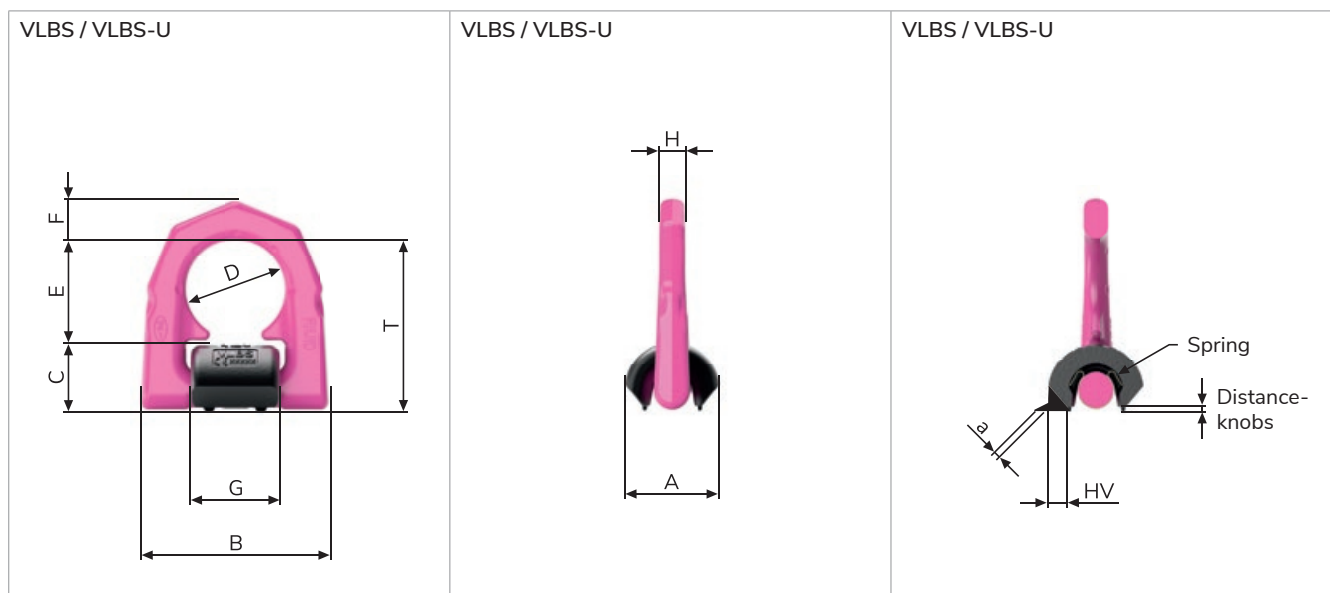

VLBS-U-LT / VLBS-P



VIP-weldable load ring /
VIP-load ring weldable-captive.

PRODUCT FEATURES

- Suspension ring can be pivoted through 180°.
- VLBS-U-LT: Proof of deep temperature ability down to -45° C via notch bar impact test.
- Suspension ring adjustable in the required position (VLBS-U-LT).
- Suspension ring and weld-on block for VLBS-U-LT is captive due to the retaining spring.
- VLBS-P for welding on pipes with a pipe diameter of 80 mm to 220 mm.



VLBS-U-LT



VLBS-P

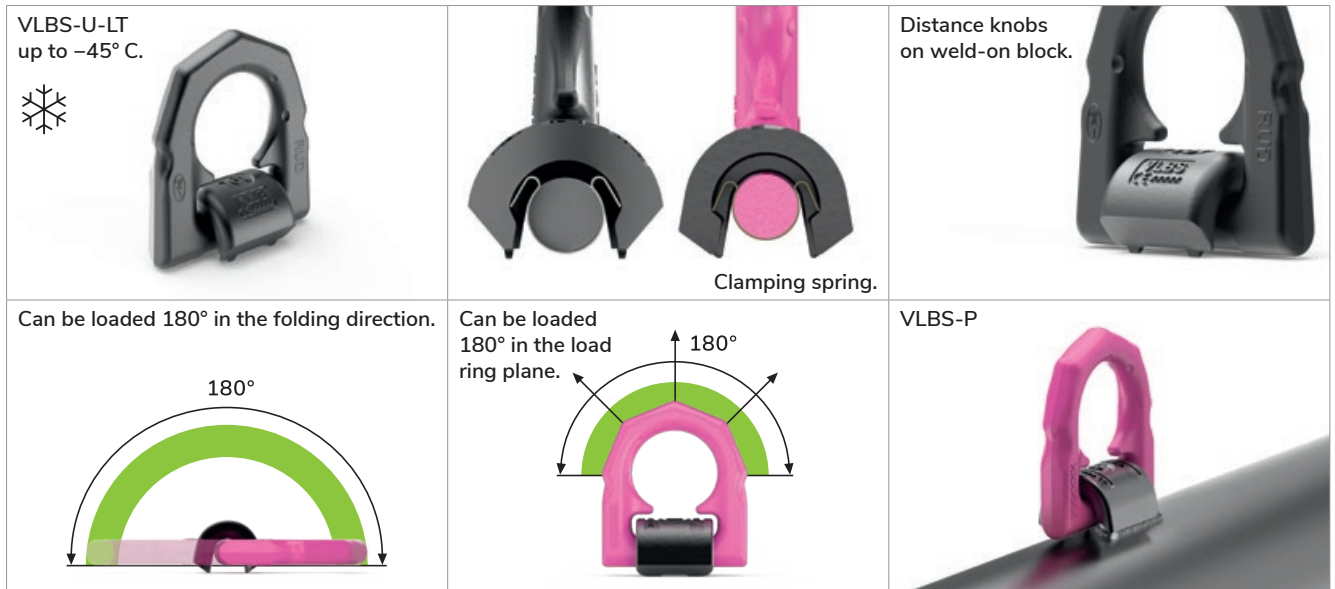

VLBS-U-LT / VLBS-P

Technical data.

VLBS-U-LT – VIP-WELDABLE LOAD RING FOR LOW TEMPERATURES.

Type	WLL [t]	Weight (kg/unit)	T [mm]	A [mm]	B [mm]	C [mm]	D [mm]	E [mm]	F [mm]	G [mm]	H [mm]	Welding seam	Ref. No.
VLBS-U-LT 2.5t	2.5	0.53	75	36	77	27	45	47	16	40	14	HV7 + a3	7903522
VLBS-U-LT 4t	4	0.76	83	42	87	31	51	52	18	46	16	HV8 + a3	7903400
VLBS-U-LT 6.7t	6.7	1.9	117	61	115	44	67	73	24	60	22	HV12 + a4	7903684
VLBS-U-LT 10t	10	2.76	126	75	129	55	67	71	26.5	60	26	HV16 + a4	7903135

Subject to technical changes!

VLBS-P – VIP-LOAD RING WELDABLE PIPES (FOR PIPES Ø 82–Ø 220 mm).

Type	WLL [t]	Weight (kg/unit)	T [mm]	A [mm]	B [mm]	C [mm]	D [mm]	E [mm]	F [mm]	G [mm]	H [mm]	Welding seam	Ref. No.
VLBS-P 4t	4	0.8	87	45	87	35	51	52	18	46	16.5	HV13 concave	7995472

Subject to technical changes!

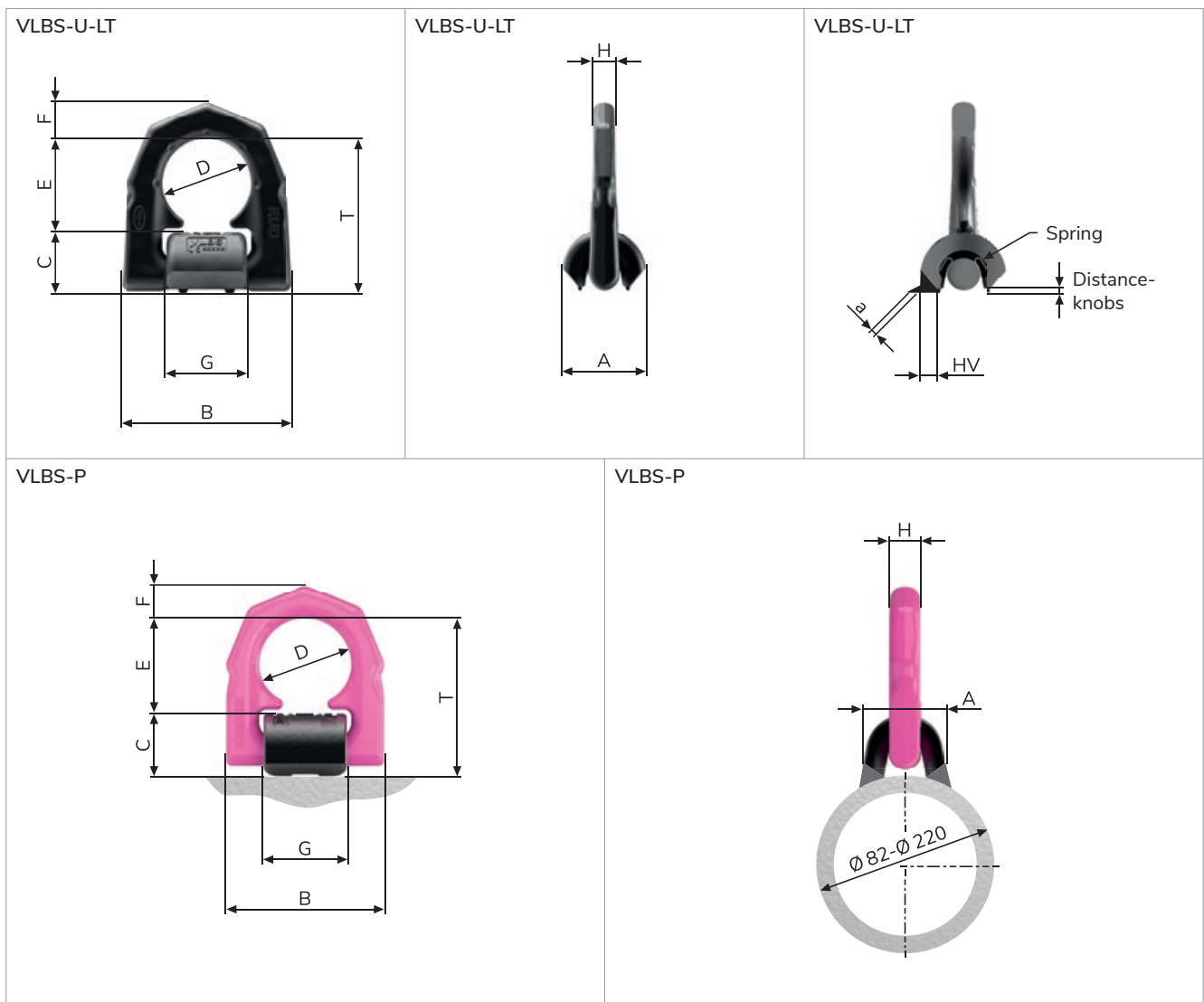

VRBS-FIX

VIP-Load ring weldable FIX.



PRODUCT FEATURES

- Large WLL range 4 t – 100 t.
- Split force introduction thanks to multiple point fixing.
- Suspension ring can be pivoted through 180°.
- WLL possible up to 90° in load ring plane.
- Thanks to the weld arrangement (circular fillet weld), no contact/crevice corrosion can occur.
- Forged markings for easy determination of the load angle.
- Patented wear markings for easy determination of wear.
- The clamping spring achieves noise reduction and keeps the suspension ring in the desired direction.



✓ Tested and certified by DGVU.

Test criteria: GS-HM-36:2021-09
Certificate no.: HM 220056

- No time-consuming alignment of the weld-on blocks to the ring link.
- Parts firmly connected through radial clamping springs.
- No rusting: all-round HY weld.

VRBS-FIX / VRL-FIX / VASK-FIX

Technical data.

VRBS-FIX – VIP-LOAD RING WITH CIRCULAR WELDING SEAM.

Type	WLL [t]	Weight (kg/unit)	T [mm]	A [mm]	B [mm]	C [mm]	D [mm]	E [mm]	F [mm]	Welding seam	Ref. No.
VRBS-FIX 4t	4	0.94	74	60	14	39	48	132	69	HY 3	7999019
VRBS-FIX 6.7t	6.7	2.24	97	88	20	50	60	167	91	HY 5	7999020
VRBS-FIX 10t	10	3.72	108	100	22	60	65	191	100	HY 6	7999021
VRBS-FIX 16t	16	8.23	140	130	30	72	90	267	134	HY 9	7999301
VRBS-FIX 31.5t	31.5	18.36	202	160	42	99	130	366	195	HY 12	7999302
VRBS-FIX 50t	50	64.86	330	246	70	148	230	596	335	HY 19	7906272
VRBS-FIX 100t	100	148.2	390	320	97	195	250	763	392	HY 28	7906273

Subject to technical changes!

VRL-FIX – OCTAGONAL RING LINK.

Type	WLL [t]	Weight (kg/unit)	T [mm]	A [mm]	B [mm]	C [mm]	D [mm]	E [mm]	F [mm]	Welding seam	Ref. No.
VRL-FIX 4t	4	0.4	55	107	14	69	48	17	18	76	7906890
VRL-FIX 6.7t	6.7	0.93	71	134	19	90	60	23	24	99	7906891
VRL-FIX 10t	10	1.44	78	152	19.5	97	65	28	29	105	7906892
VRL-FIX 16t	16	3.2	104	204	27.5	131	90	35	37	146	7906893
VRL-FIX 31.5t	31.5	8.8	152	292	41	192	130	46	47	214	7906894
VRL-FIX 50t	50	27.9	265	510	70	335	230	63	63	371	7907412
VRL-FIX 100t	100	64.4	295	606	97	392	250	90	90	447	7906204

Subject to technical changes!

VASK-FIX – WELD-ON BLOCK.

Type	WLL [t]	Weight (kg/unit)	T [mm]	A [mm]	B [mm]	C [mm]	D [mm]	E [mm]	F [mm]	Welding seam	Ref. No.
VASK-FIX 4t	4	0.28	27	60	-	38	15.5	-	29	HY 3	7908210
VASK-FIX 6.7t	6.7	0.63	37	88	-	52	21.5	-	34	HY 5	7908211
VASK-FIX 10t	10	1.15	43	100	-	60	26.5	-	44	HY 6	7908212
VASK-FIX 16t	16	2.43	52	130	-	72	33	-	62	HY 9	7908213
VASK-FIX 31.5t	31.5	4.93	71	160	-	99	44	-	76	HY 12	7908214
VASK-FIX 50t	50	18.4	98	246	-	148	66	-	123	HY 19	7906205
VASK-FIX 100t	100	41.9	142	320	-	195	94	-	166	HY 28	7906206

Subject to technical changes!

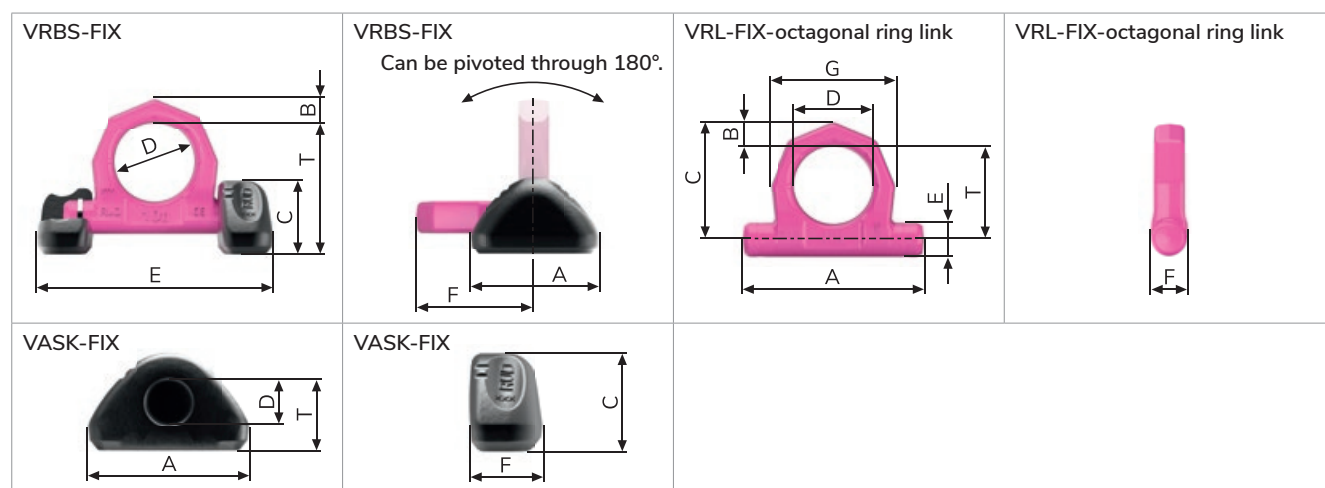

VRBS

VIP-Load ring for welding.



PRODUCT FEATURES

- Large WLL range 4 t – 31.5 t.
- Clear indication of the minimum WLL for all loading directions.
- Patented wear markings for easy determination of wear.
- Distance knobs on the weld-on block for the necessary distance for root welding.
- The weld-on block is forged from a material that is easy to weld.



<p>Split force introduction.</p>	<p>WLL possible up to 90° in load ring plane.</p>	<p>180° pivoting.</p>
<p>Patented wear marker.</p>	<p>WLL angle in load ring plane.</p>	<p>WLL angle for side loading.</p>

✓ Corresponds with the test criteria of BG/DGUV "GS-OA-15-04".

- Split force introduction thanks to multiple point fixing.
- Suspension ring pivots 180°.
- WLL possible up to 90° in load ring plane.

VRBS / VRL / VASK

Technical data.

VRBS – VIP-LOAD RING FOR WELDING.

Type	WLL [t]	Weight (kg/unit)	T [mm]	A [mm]	B [mm]	C [mm]	D [mm]	E [mm]	F [mm]	Welding seam	Ref. No.
VRBS 4t	4	0.8	65	62	14	28	48	135	71	HY 4 + a3	7992488
VRBS 6.7 t	6.7	1.6	84	88	20	39	60	170	92	HY 5.5 + a3	7992489
VRBS 10t	10	2.6	95	100	22	46	65	195	100	HY 6 + a4	7992490
VRBS 16t	16	5.53	127	130	30	57	90	263	134	HY 8.5 + a4	7992491
VRBS 31.5t	31.5	15.6	178	160	42	79	130	375	195	HY 18 + a4	60267

Subject to technical changes!

VRL-FIX-OCTAGONAL RING LINK (UNIVERSAL DESIGN FOR VRBS-FIX AND VRBS).

Type	WLL [t]	Weight (kg/unit)	T [mm]	A [mm]	B [mm]	C [mm]	D [mm]	E [mm]	F [mm]	G	Ref. No.
VRL-FIX 4t	4	0.4	55	107	14	69	48	17	18	76	7906890
VRL-FIX 6.7 t	6.7	0.93	71	134	19	90	60	23	24	99	7906891
VRL-FIX 10t	10	1.44	78	152	19.5	97	65	28	29	105	7906892
VRL-FIX 16t	16	3.2	104	204	27.5	131	90	35	37	146	7906893
VRL-FIX 31.5t	31.5	8.8	152	292	41	193	130	46	47	214	7906894

Subject to technical changes!

VASK – VRBS-WELD-ON BLOCK.

Type	WLL [t]	Weight (kg/unit)	T [mm]	A [mm]	B [mm]	C [mm]	D [mm]	E [mm]	F [mm]	Welding seam	Ref. No.
VASK 4t	4	0.13	19	62	-	28	-	-	30	HY 4 + a3	7992004
VASK 6.7 t	6.7	0.34	24	88	-	39	-	-	36	HY 5.5 + a3	7992005
VASK 10t	10	0.63	31	100	-	46	-	-	46	HY 6 + a4	7992007
VASK 16t	16	1.3	39	130	-	57	-	-	57	HY 8.5 + a4	7992008
VASK 31.5t	31.5	3.24	49	160	-	78	-	-	82	HY 18 + a4	7987160

Subject to technical changes!

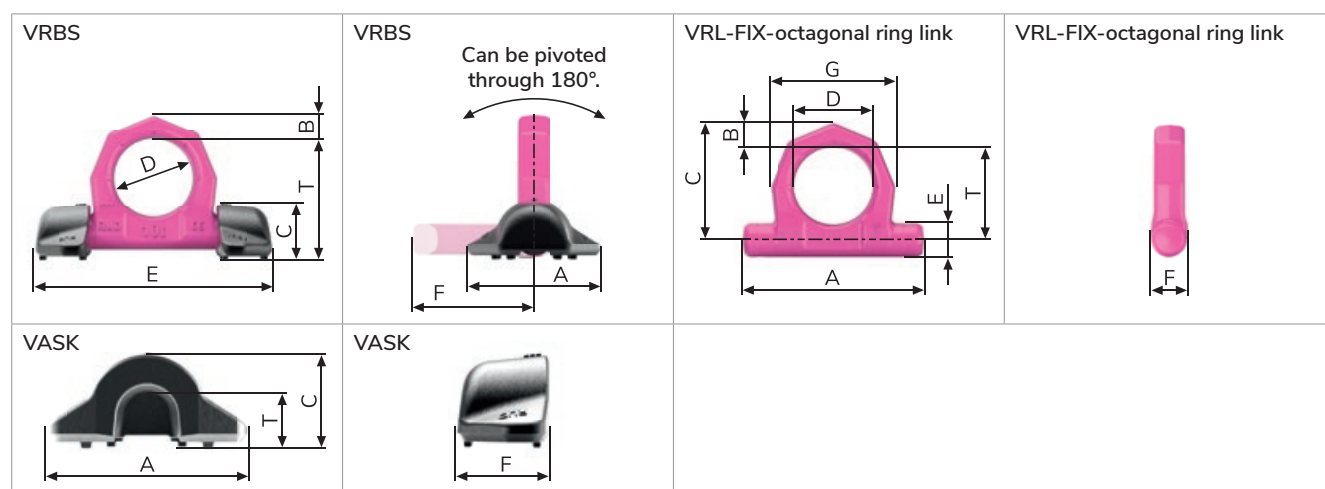

VRBK-FIX

VIP-Load ring edge FIX.



PRODUCT FEATURES

- Large WLL range 4 t – 50 t.
- Split force introduction thanks to multiple point fixing.
- Suspension ring pivots 270°.
- WLL possible up to 90° in load ring plane.
- Thanks to the weld arrangement (circular fillet weld), no contact/crevice corrosion can occur.
- Patented wear markings for easy determination of wear.
- The clamping spring achieves noise reduction and keeps the suspension ring in the desired direction.

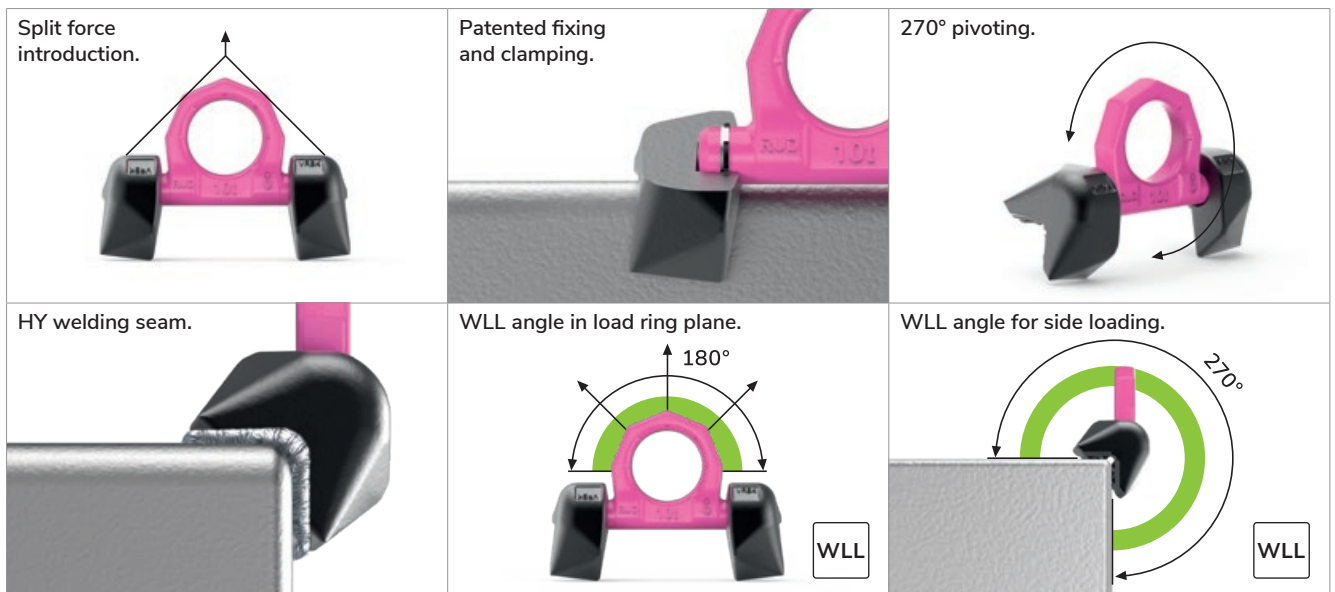

✓ Tested and certified by DGVU.

Test criteria: GS-OA-15-04: 2015-12
Certificate no.: OA 1951041

- Can be pivoted through 270°.
- Pre-assembled unit of suspension ring and weld-on blocks.
- No rusting: all-round HY weld.

VRBK-FIX / VRL-FIX / VASKK-FIX

Technical data.

VRBS-FIX – WELDABLE VIP-LOAD RING FOR 90° EDGES.

Type	WLL [t]	Weight (kg/unit)	T [mm]	A [mm]	B [mm]	C [mm]	D [mm]	E [mm]	F [mm]	Welding seam	Ref. No.
VRBK-FIX 4t	4	1.05	65	32	14	28	48	141	30	HY 4 + a3	7902149
VRBK-FIX 6.7t	6.7	2.16	84	40	20	35	60	181	34	HY 5 + a3	7902150
VRBK-FIX 10t	10	4.4	94	52	22	46	65	212	46	HY 8 + a3	7902256
VRBK-FIX 16t	16	9.73	126	66	27	57	90	284	64	HY 10	7909845
VRBK-FIX 31.5t	31.5	24.84	177	89	42	78	130	394	70	HY 17	7906225
VRBK 50t	50	76.35	303	134	70	118	230	626	96	HY 25	7904653

Subject to technical changes!

VRL-FIX – OCTAGONAL RING LINK.

Type	WLL [t]	Weight (kg/unit)	T [mm]	A [mm]	B [mm]	C [mm]	D [mm]	E [mm]	F [mm]	G [mm]	Ref. No.
VRL-FIX 4t	4	0.4	55	107	14	69	48	17	18	76	7906890
VRL-FIX 6.7t	6.7	0.93	71	134	19	90	60	23	24	99	7906891
VRL-FIX 10t	10	1.44	78	152	19.5	97	65	28	29	105	7906892
VRL-FIX 16t	16	3.2	104	204	27.5	131	90	35	37	146	7906893
VRL-FIX 31.5t	31.5	8.8	152	292	41	193	130	46	47	214	7906894
VRL-FIX 50t	50	27.9	265	510	70	335	230	63	63	371	7907412

Subject to technical changes!

VASKK-FIX – WELD-ON BLOCK.

Type	WLL [t]	Weight (kg/unit)	T [mm]	A [mm]	B [mm]	C [mm]	D [mm]	E [mm]	F [mm]	Welding seam	Ref. No.
VASKK-FIX 4t	4	0.33	18	32	-	28	18.5	-	30	HY 4 + a3	7910942
VASKK-FIX 6.7t	6.7	0.57	24	40	-	35	24.5	-	34	HY 5 + a3	7910943
VASKK-FIX 10t	10	1.42	29	52	-	46	30	-	46	HY 8 + a3	7910944
VASKK-FIX 16t	16	3.32	41	66	-	57	37	-	65	HY 10	7909844
VASKK-FIX 31.5t	31.5	7.9	51	89	-	78	48.5	-	70	HY 17	7910279
VASKK 50t	50	23.5	71	134	-	118	67	-	96	HY 25	7903914

Subject to technical changes!

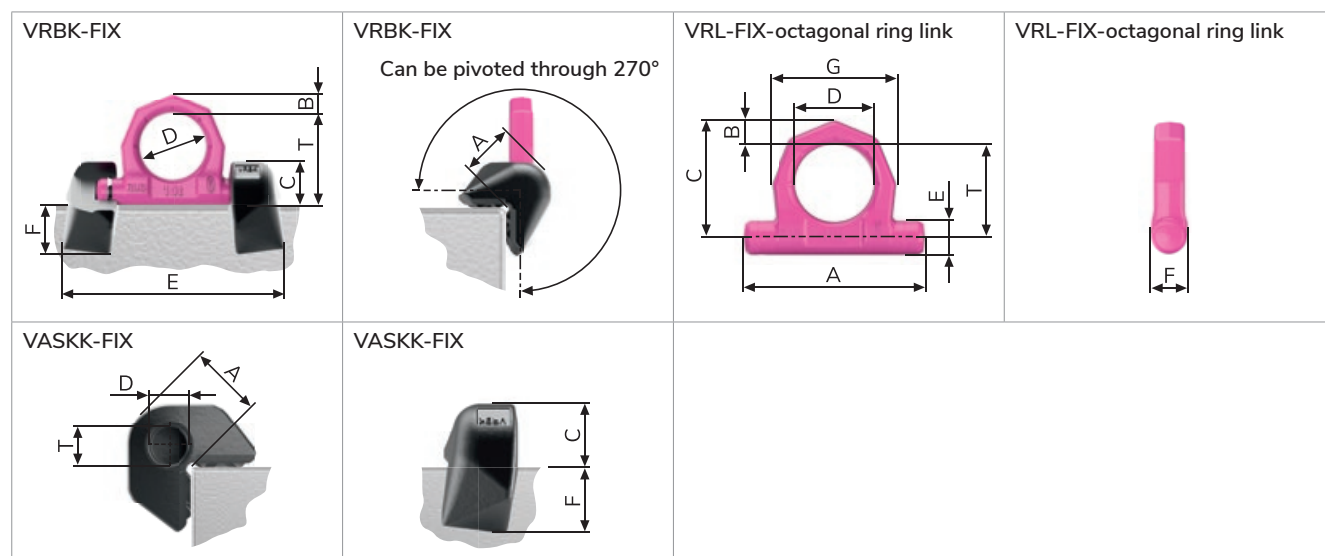

W-ABA



Lifting point that can be loaded on all sides.

PRODUCT FEATURES

- Large WLL range 0.8 t – 31.5 t.
- Forged from a single piece, no rattling noise or shaking even with strong vibrations or shock loads, easy hinging of the lifting means possible.
- The weld arrangement (circular fillet weld) fulfils the requirements of DIN EN 1090, i.e. the endless weld seam prevents the formation of contact/crevice corrosion (thus suitable for outdoor constructions).
- Patented wear markings for easy determination of wear.

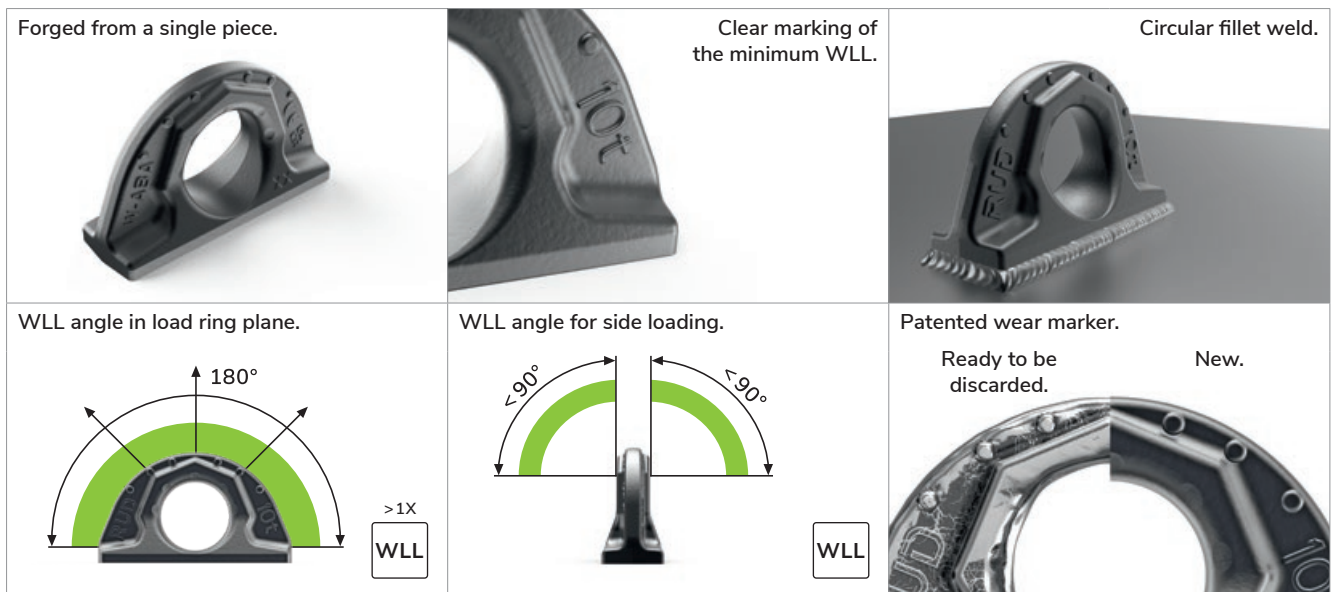

✓ Tested and certified by DGUV.

Test criteria: GS-OA-15-04
Certificate no.: OA 1951042

- 4-times the safety against breakage.
- Patented wear markings inside and out.
- Tempered main body, making it more wear resistant.

W-ABA

Technical data.

W-ABA – WELD-ON POINT THAT CAN BE LOADED ON ALL SIDES.

Type	WLL [t]	Weight (kg/unit)	T [mm]	A [mm]	B [mm]	C [mm]	D [mm]	E [mm]	F [mm]	Welding seam	Ref. No.
W-ABA 0.8t	0.8 (2) ¹	0.2	38	22	12	70	32	12	50	a3	7907698
W-ABA 1.6t	1.6 (4) ¹	0.45	42	30	16	100	35	16	57	a4	7900352
W-ABA 3.2t	3.2 (9) ¹	1.15	59	41	23	137	50	21	80	a6	7900353
W-ABA 5t	5 (12) ¹	2.26	72	51	27	172	60	28	99	a7	7900354
W-ABA 10t	10 (20) ¹	5.37	95	70	38	228	80	35	130	a8	7900355
W-ABA 20t	20	10.72	135	90	52	272	115	40	175	a12	7902174
W-ABA 31.5t	31.5	18.33	154	108	64	320	130	50	204	a15	7902175

¹ () = Higher WLL with load in load ring plane.

Subject to technical changes!

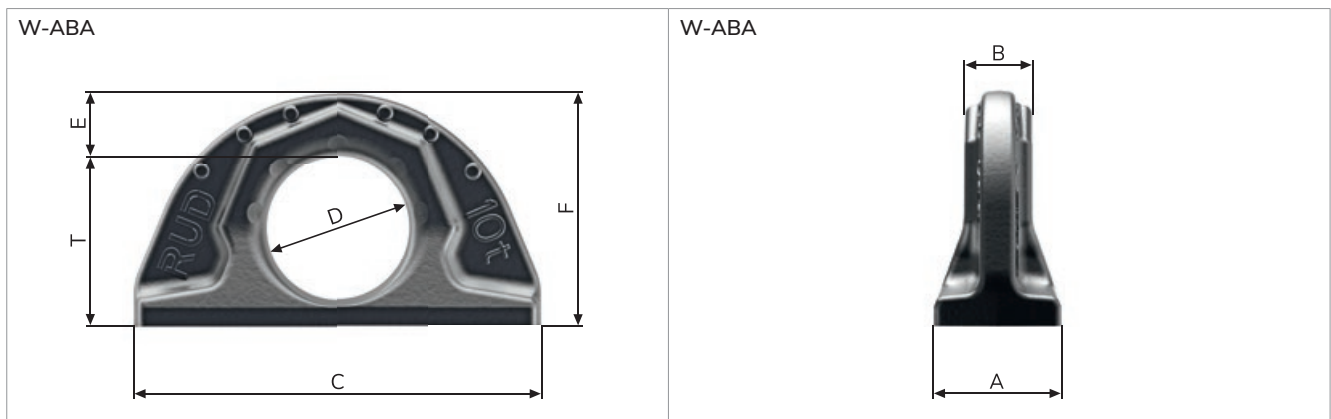

VABH-W / VCGH-S

4:1  -40° 200°C -20° 200°C 400°C max.
(1) (2)

VIP-weld-on-block.



VABH-W (1)



VCGH-S (2)

PRODUCT FEATURES

- Large WLL range 1.5 t – 20 t.
- For combination with all conventional lifting means without additional connecting elements.
- Patented wear markings for easy determination of wear.
- Robust forged safety latch.
- Phosphated surface.
- VABH-W also for use an excavator hook.
- Simple and fast welding installation.

<p>Robust forged hook latch.</p> 	<p>For combination with all conventional lifting means.</p> 	<p>Patented wear marker.</p>  <p>Ready to be discarded. New.</p>
<p>VABH-W</p>  <p>150° 45° 45°</p>	<p>VCGH-S</p>  <p>45° 15° 15°</p>	

✓ Corresponds with the test criteria of BG/DGUV "GS-OA-15-04".

- As a weld-on point on trusses and beams.
- For ropes and round slings.
- For lifting means with eye or oval ring.

VABH-W / VCGH-S

Technical data.

VABH-W – VIP-WELD-ON-BLOCK.

Type	WLL [t]	Weight (kg/unit)	T [mm]	A [mm]	B [mm]	C [mm]	D [mm]	E [mm]	F [mm]	I [mm]	Welding seam	Ref. No.
VABH-W 1.5t	1.5	0.8	26	7.5	76	115	111	70	26	38	a4	7991208
VABH-W 2.5t	2.5	1.8	33	8.5	98	148	143	85	31.5	49	a5	7991209
VABH-W 4t	4	3.12	40	12	119	168	164	104	35	59	a6	7991210
VABH-W 6.7t	6.7	5.89	51	13	147	205	200	120	40	70	a6	8502239

Subject to technical changes!

VCGH-S – VIP-WELD-ON-BLOCK.

Type	WLL [t]	Weight (kg/unit)	T [mm]	A [mm]	B [mm]	C [mm]	D [mm]	E [mm]	F [mm]	I [mm]	Welding seam	Ref. No.
VCGH-S 16	10	5.67	49	15	141	200	220	100	48	69	a8	7984047
VCGH-S 20	16	8.4	69	20	187	272	288	120	63	87	a8	7984310
VCGH-S 22	20	14.5	74	20	196	276	292	120	63	92	a8	7984312

Subject to technical changes!

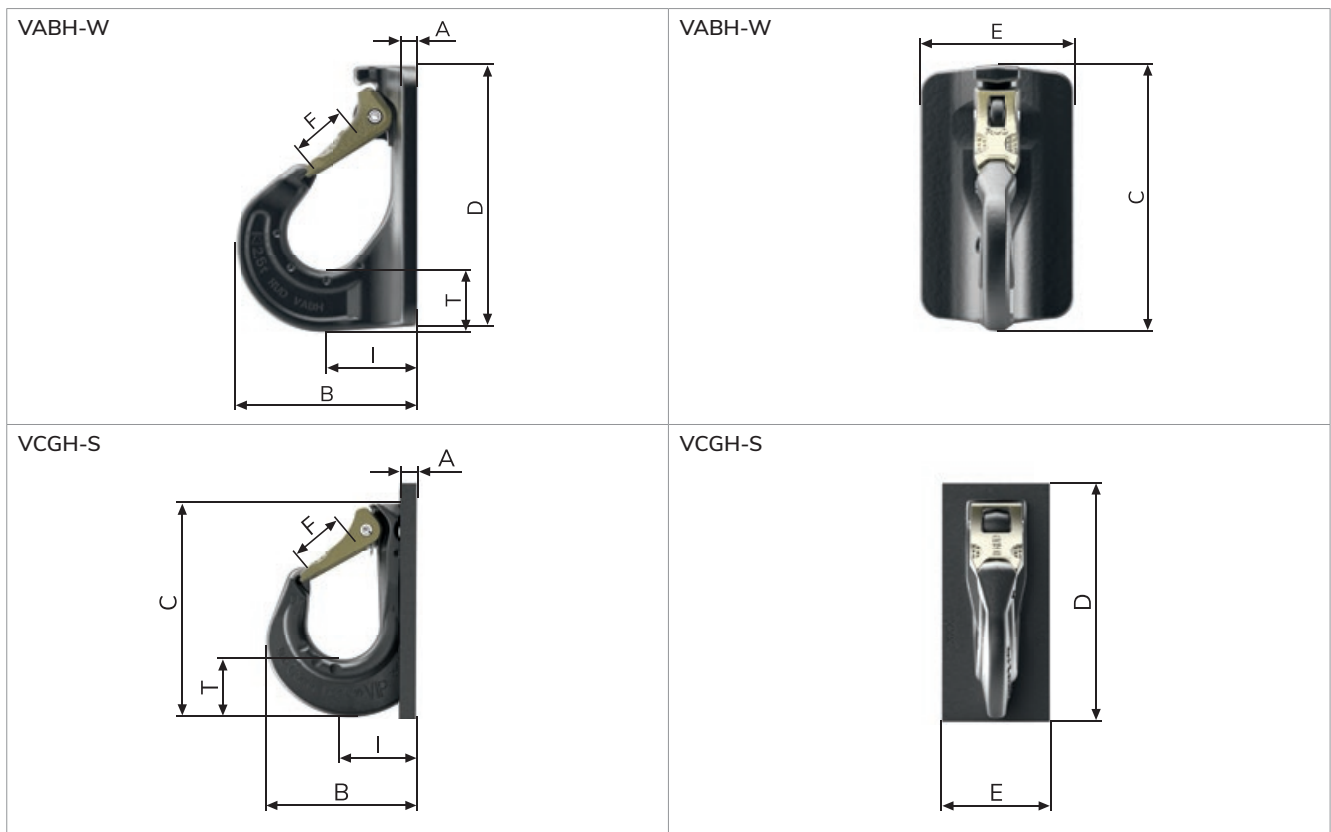

WPP-S / -B / -VIP



PowerPoint®-Star / eye connection /
-VIP-weldable chain connection.



WPP-S

WPP-B

WPP-VIP

PRODUCT FEATURES

- Large WLL range 0.63 t – 8 t.
- WPP-S: weldable universal connection with hook for ring suspensions, round slings, wire ropes, hook suspensions.
- WPP-B: weldable eye connection for hook suspension.
- WPP-VIP: weldable direct chain connection.
- Rotatable 90° to the bolt-on direction under rated WLL.
- Lowest kinking possibility due to cardan joint.
- Can be rotated parallel to the weld-on surface under rated WLL.

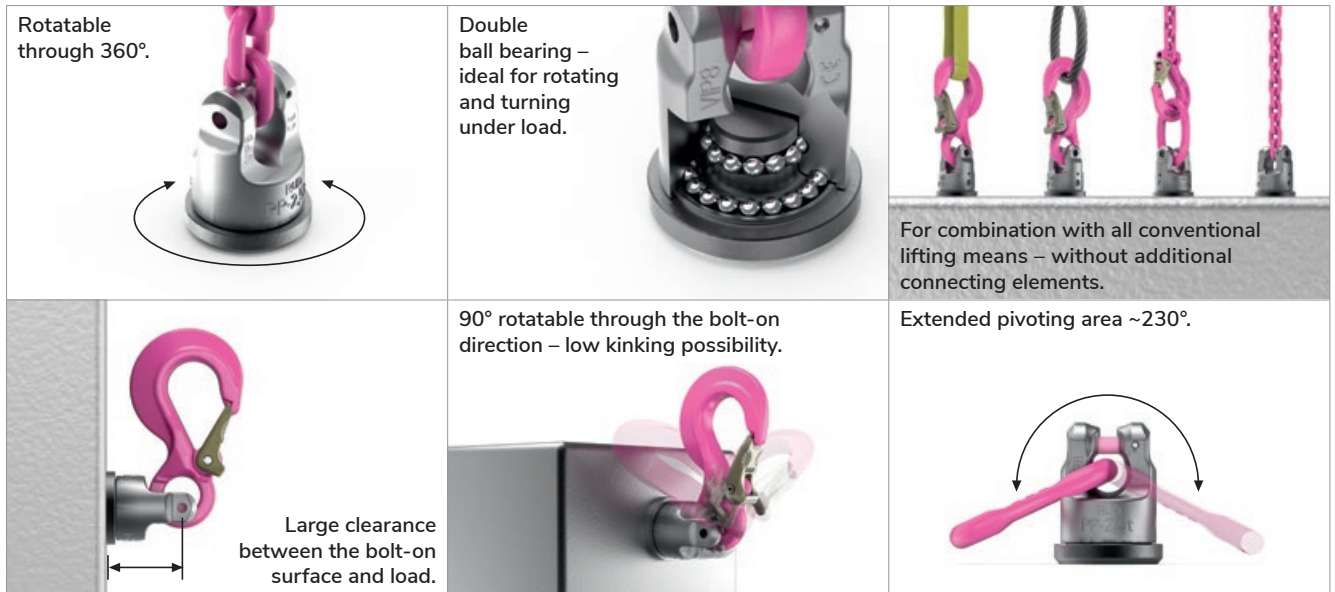

✓ Corresponds with the test criteria of BG/DGUV "GS-OA-15-04".

- 360° rotatable, 230° pivotable.
- Double ball bearing for tilting, rotating and turning.
- Universal, non-mix-up VIP connection for chains, hooks and eyes.

WPP-S / -B / -VIP

Technical data.

WPP-S – POWERPOINT-STAR UNIVERSAL CONNECTION FOR WELDING (ROTATABLE).

Type	WLL [t]	Weight (kg/unit)	T [mm]	A [mm]	B [mm]	C [mm]	D [mm]	G [mm]	N [mm]	Welding seam	Ref. No.
WPP-S0.63t	0.63	0.4	115	13	75	18	40	40	-	a4	7990721
WPP-S 1.5t	1.5	1	147	20	97	25	46	50	-	a5	7989944
WPP-S 2.5t	2.5	1.7	187	28	126	30	61	61	-	HY 3 + a5	7989945
WPP-S 4t	4	3.4	227	36	150	35	78	77	-	HY 3 + a6	7989946
WPP-S 5t	5 (6.7) ¹	7.1	267	37	174	40	95	93	-	HY 3 + a8	7989947
WPP-S 8t	8 (10) ¹	8.2	310	49	208	48	100	102	-	HY 3 + a10	7989948

¹ () = Higher WLL with axial load.

Subject to technical changes!

WPP-B – POWERPOINT EYE CONNECTION FOR HOOK SUSPENSION FOR WELDING (ROTATABLE).

Type	WLL [t]	Weight (kg/unit)	T [mm]	A [mm]	B [mm]	C [mm]	D [mm]	G [mm]	N [mm]	Welding seam	Ref. No.
WPP-B 0.63t	0.63	0.35	105	9	65	35	40	40	15	a4	7989954
WPP-B 1.5t	1.5	0.4	115	11	65	35	46	50	15	a5	7989955
WPP-B 2.5t	2.5	1	135	13	74	40	61	61	18	HY 3 + a5	7989956
WPP-B 4t	4	2.3	172	16	95	45	78	77	20	HY 3 + a6	7989957
WPP-B 5t	5 (6.7) ¹	4.7	223	19	130	60	95	93	25	HY 3 + a8	7989958
WPP-B 8t	8 (10) ¹	5.3	242	24	140	65	100	102	28	HY 3 + a10	7989959

¹ () = Higher WLL with axial load.

Subject to technical changes!

WPP-VIP – POWERPOINT FOR VIP-CHAIN CONNECTION FOR WELDING (ROTATABLE).

Type	WLL [t]	Weight (kg/unit)	T [mm]	A [mm]	B [mm]	C [mm]	D [mm]	G [mm]	N [mm]	Welding seam	Ref. No.
WPP-VIP4-0.63t	0.63	0.23	41	4	-	-	40	-	-	a4	7989960
WPP-VIP6-1.5t	1.5	0.39	50	6	-	-	46	-	-	a5	7989961
WPP-VIP8-2.5t	2.5	0.85	61	8	-	-	61	-	-	HY 3 + a5	7989962
WPP-VIP10-4t	4	1.8	77	10	-	-	78	-	-	HY 3 + a6	7989963
WPP-VIP13-5t	5 (6.7) ¹	3.4	93	13	-	-	95	-	-	HY 3 + a8	7989964
WPP-VIP16-8t	8 (10) ¹	4.5	102	16	-	-	100	-	-	HY 3 + a10	7989965

¹ () = Higher WLL with axial load.

Subject to technical changes!

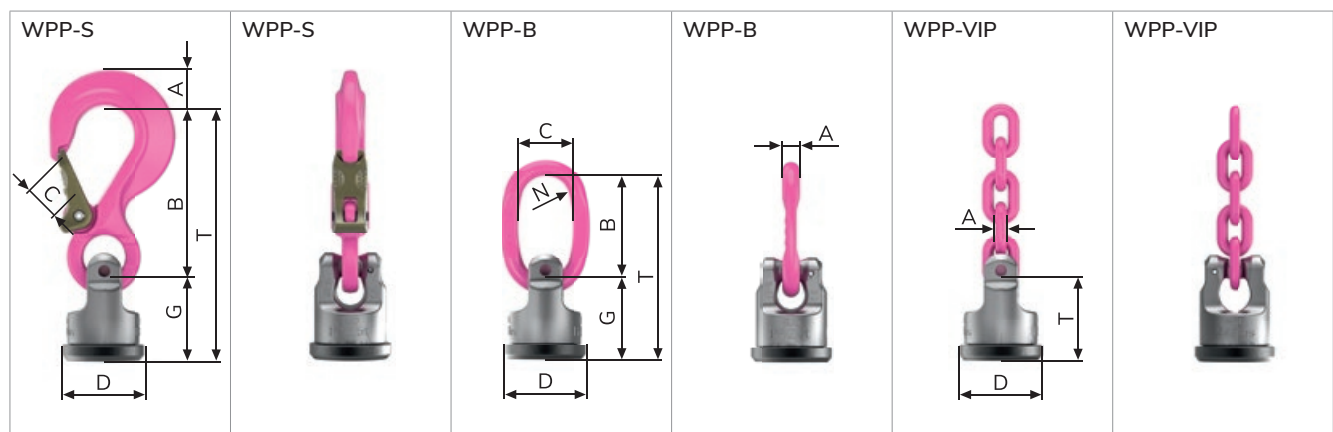

VWBS / VWBS-KA



Technical data.

VWBS¹ – VIP-LOAD RING FOR WELDING.

Type	WLL [t]	Weight (kg/unit)	T [mm]	A [mm]	B [mm]	C [mm]	D [mm]	G [mm]	N [mm]	Welding seam	Ref. No.
VWBS 40 (50) t	40 (50) ²	27.9	380	46	170	110	170	161	55	HY 22 + a19	7903650

¹ Rotatable.

² () = Higher WLL with axial load.

Subject to technical changes!

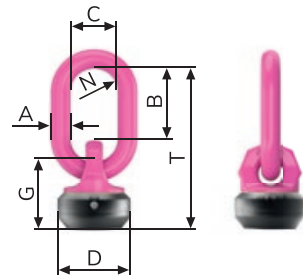

VWBS-KA¹ – VIP-LOAD RING FOR WELDING WITH CHAIN CONNECTION.

Type	WLL [t]	Weight (kg/unit)	T [mm]	A [mm]	B [mm]	C [mm]	D [mm]	G [mm]	N [mm]	Welding seam	Ref. No.
VWBS-KA-28-31.5 t	31.5	24	146	28	-	-	170	-	-	HY 22 + a19	7903440

¹ Rotatable.

Subject to technical changes!

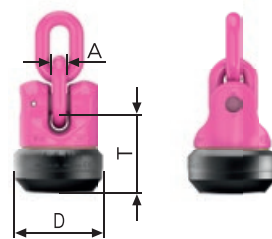

WPPH / -S / -B / -VIP / -KA



Technical data.

WPPH-S¹ – POWERPOINT-STAR UNIVERSAL CONNECTION FOR WELDING.

Type	WLL [t]	Weight (kg/unit)	T [mm]	A [mm]	B [mm]	C [mm]	D [mm]	G [mm]	N [mm]	Welding seam	Ref. No.
WPPH-S 0.63t	0.63	0.3	109	13	75	18	34	34	-	a4	7900722
WPPH-S 1.5t	1.5	0.9	141	20	97	25	40	44	-	a5	7989966
WPPH-S 2.5t	2.5	1.5	179	28	126	30	53	53	-	HY 3 + a5	7989967
WPPH-S 4t	4	2.9	217	36	150	35	68	66	-	HY 3 + a6	7989968
WPPH-S 5t	5 (6.7) ²	6.1	253	37	174	40	83	79	-	HY 3 + a8	7989969
WPPH-S 8t	8 (10) ²	7.2	296	49	208	48	88	88	-	HY 3 + a10	7989970

¹ Not rotatable.

² () = Higher WLL with axial load.

Subject to technical changes!

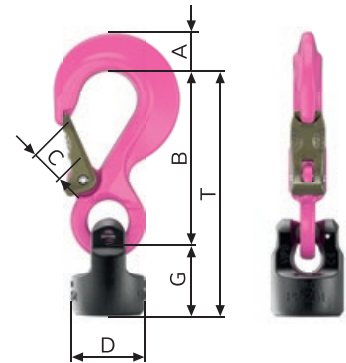

WPPH-B¹ – POWERPOINT EYE CONNECTION FOR HOOK SUSPENSION FOR WELDING.

Type	WLL [t]	Weight (kg/unit)	T [mm]	A [mm]	B [mm]	C [mm]	D [mm]	G [mm]	N [mm]	Welding seam	Ref. No.
WPPH-B 0.63t	0.63	0.15	99	9	65	35	34	34	15	a4	7989976
WPPH-B 1.5t	1.5	0.3	109	11	65	35	40	44	15	a5	7989977
WPPH-B 2.5t	2.5	0.9	127	13	74	40	53	53	18	HY 3 + a5	7989978
WPPH-B 4t	4	1.8	161	16	95	45	68	66	20	HY 3 + a6	7989979
WPPH-B 5t	5 (6.7) ²	3.7	209	21	130	60	83	79	25	HY 3 + a8	7989980
WPPH-B 8t	8 (10) ²	4.4	228	24	140	65	88	88	28	HY 3 + a10	7989981

¹ Not rotatable.

² () = Higher WLL with axial load.

Subject to technical changes!

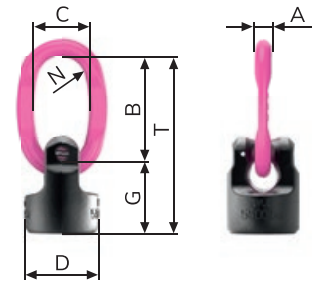

WPPH-VIP¹ – POWERPOINT FOR VIP-CHAIN CONNECTION FOR WELDING.

Type	WLL [t]	Weight (kg/unit)	T [mm]	A [mm]	B [mm]	C [mm]	D [mm]	G [mm]	N [mm]	Welding seam	Ref. No.
WPPH-VIP4-0.63t	0.63	0.17	34	4	-	-	34	-	-	a4	7989982
WPPH-VIP6-1.5t	1.5	0.33	44	6	-	-	40	-	-	a5	7989983
WPPH-VIP8-2.5t	2.5	0.75	53	8	-	-	53	-	-	HY 3 + a5	7989984
WPPH-VIP10-4t	4	1.47	66	10	-	-	68	-	-	HY 3 + a6	7989985
WPPH-VIP13-5t	5 (6.7) ²	2.65	79	13	-	-	83	-	-	HY 3 + a8	7989986
WPPH-VIP16-8t	8 (10) ²	3.5	88	16	-	-	88	-	-	HY 3 + a10	7989987

¹ Not rotatable.

² () = Higher WLL with axial load.

Subject to technical changes!

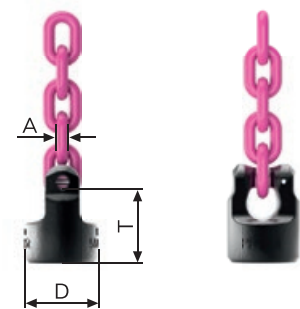

WPPH-KA¹ – POWERPOINT FOR VIP-CHAIN CONNECTION FOR WELDING.

Type	WLL [t]	Weight (kg/unit)	T [mm]	A [mm]	B [mm]	C [mm]	D [mm]	G [mm]	N [mm]	Welding seam	Ref. No.
WPPH-KA-28-31.5t	31.5	12.1	81	28	-	-	148	-	-	HY 10 + a15	7903438

¹ Not rotatable.

Subject to technical changes!

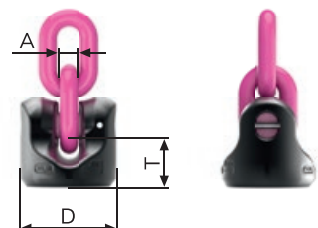

RUD CONFIGURATION TOOLS: SOMETHING YOU CAN COUNT ON.

Our service for designers and users: With several configuration tools, we support you in the safe planning of lifting points and the correct configuration of lashing chains. Simply download our smartphone app for lashing equipment calculation free of charge from the App Store or Google Play Store. You can use our tools for lifting points, suspension and lashing chains calculation directly on our website at www.rud.com





TESTING LIFTING POINTS.

WHAT YOU SHOULD KNOW ABOUT TESTING AND WHAT TO CONSIDER.

Lifting points are safety-relevant products. Therefore, please note that all lifting points must be checked at least once a year by an expert for their continued suitability.

The following must be tested:

- directly after installation or welding,
- at intervals depending on the WLL on the lifting point,
- after damages and special incidents.



THE FOLLOWING IS IMPORTANT FOR TESTING LIFTING POINTS:

- Make sure that the bolts are tightly fitted; check the torque moment.
- Check the lifting point for completeness.
- Check the lifting point for the complete, legible WLL information and the manufacturer's mark.
- Examine the lifting point for deformations on load-bearing parts such as the main body, suspension bracket or strap.
- Check the lifting point for mechanical damage such as large notches, in particular in areas subject to tensile loads.
- Check the lifting point for cross-sectional reductions of > 10 % due to wear occurrence.
- Check the lifting point for severe corrosion (pitting).
- Pay attention to cracks on supporting parts.
- Check weldable lifting points for cracks or other damage to the weld seam.
- Check the lifting point for the correct bolt length, bolt quality and screw-in length.
- Check bolt and bolt thread of the lifting point for function and damage.
- In the case of rotatable lifting points, easy, shock-free rotation between the upper and lower parts must be guaranteed.
- Attention: Only the manufacturer is permitted to assemble or insert different bolt lengths for type VWBG-V. Removal of the ball bearing from the VWBG-V, VWBG, PP and WPP is prohibited.

For types PP, WPP, VWBG-V and VWBG check the maximum clearance between upper and lower part dimension "s" (see table). If the maximum clearance is exceeded, these parts may no longer be used. These parts must not be exposed to the test load – crack test only.

Important: Follow the instructions and information in the relevant operating instructions.

Type	Clearance "s"
WPP / PP-.-0.63 t to 2.5 t	max. 1.5 mm
WPP / PP-.-4 t to 8 t	max. 2.5 mm
VWBG-V 0.3 t to 0.45 t	max. 1.2 mm
VWBG-V 0.6 t to 2 t	max. 1.5 mm
VWBG-V 3.5 t to 5 t	max. 3 mm
VWBG 8 t to 35 t	max. 4 mm

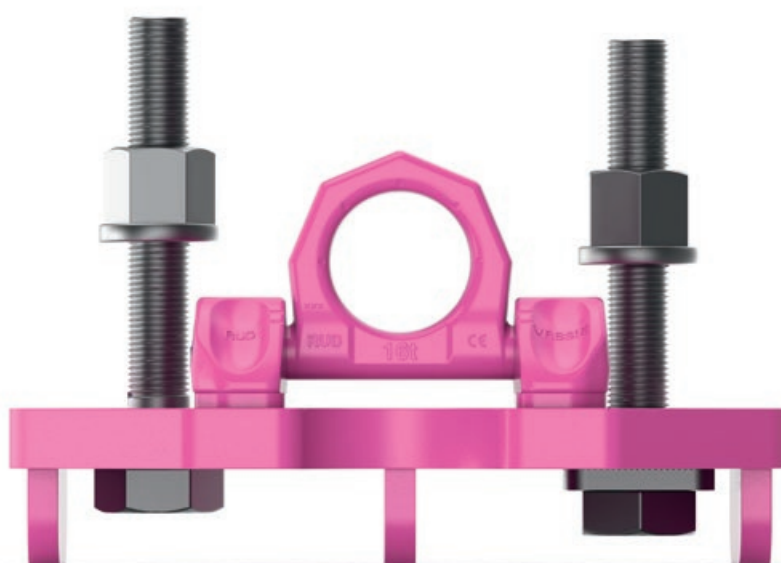

OFFER WITH A SYSTEM.

IT MIGHT BE OF INTEREST TO YOU TOO.

As a system provider, we are happy to support you holistically. This is why you will find many other products at RUD, which are essential for the safe lifting, moving and transporting of loads. Detailed information on this is available in our special catalogues or at www.rud.com.



RUD LASHING EQUIPMENT.

RUD lashing equipment in quality class 12-ICE stand for fast attachment and extra safety when transporting loads. They enable high maximum lashing forces with comparatively small chain dimensions – i.e. high ergonomics through lower weight.



RUD LIFTING MEANS.

RUD lifting means in quality classes 12-ICE and 10-VIP are the first choice for lifting and moving. They not only offer high WLL with a smaller chains diameter, but also a maximum of user-friendliness through easier, power-saving handling.



RUD LIFTING POINTS.

The right one for every application: lifting points from RUD are available in countless weldable and screwable variants. Equipped with the powerful ICE-BOLT, they achieve higher WLL and unmatched high safety factors with smaller bolt diameters.



RUD ICE-MINI: THE PERFECT CHAINS FOR THE SMALLEST LOADS.

Lifting is not always about loads weighing tonnes. Our tip: The RUD ICE-MINI lifting chains are ideal for lighter weights. Its special feature is that it can be shortened in a flash with a push button.



RUD TOOL MOVER TURNING TOOL.

With the TOOL MOVER turning tool, tools weighing a ton and susceptible or injection moulds can be turned safely, ergonomically and in a time-saving manner. With the large choice of attachment parts, you not only protect the tools, but also your employees.



RUD SEMINARS.

Stay on the ball: As a participant in our seminars and training courses, you will always be up-to-date on topics, such as safety, materials and legal regulations.



RUD EXPERT DIALOGUE.

Do you have questions, special problems or complex lifting and transport tasks? Send us an e-mail to slings@rud.com or call us on: +49 7361 504-1070.

GLOSSARY.

B

BLUE-ID SYSTEM	34–35
Bolt	32–33
Boltable lifting points	21–26, 40–99

C

Centric	44–48
Configurators	120–121

D

Deep temperature	104
------------------	-----

E

Edge solutions	106–107
Eyebolt	70–74, 77–83

F

Flange solutions	96–97
------------------	-------

H

Heavy loads	68–69
-------------	-------

I

ICE-Bolt	32–33
----------	-------

L

Lifting points boltable	14
Lifting points rigid	15
Lifting points rotatable	15
Lifting points weldable	15
Load-bearing capacity overview	36–39

M

Material properties	32–33
---------------------	-------

O

Operating equipment testing	34–35
-----------------------------	-------

P

Personal protection equipment	98–99
-------------------------------	-------

R

RFID	34–35
Risk analysis	16
Rotating and turning	18–19

S

Stainless	22, 77
-----------	--------

T

Testing lifting points	122–123
Transponder	34–35
Types of lifting points	14–15

U

Universal connection (chains, hook, eye)	54–59, 116–119
--	----------------

W

Weldable lifting points	27–29, 101–119
-------------------------	----------------

AT HOME INTERNATIONALLY.



Users all over the world appreciate our innovative strength and our intelligent solutions for lifting, moving and securing loads. To be as close as possible to our customers, we are constantly expanding our worldwide sales and service network. Our large number of RUD subsidiaries, affiliated companies and specialist trade partners ensure that our consulting expertise and our products are available worldwide.



RUD Ketten
Rieger & Dietz GmbH u. Co. KG

Friedensinsel
73432 Aalen, Germany

Phone: +49 7361 504-1070
Fax: +49 7361 504-1460

Mail: sling@rud.com
Web: slingandlashing.rud.com
www.rud.com